

The Future of Solar Energy

AN INTERDISCIPLINARY MIT STUDY

The
Future of
Solar
Energy

AN INTERDISCIPLINARY MIT STUDY

Other Reports in the MIT *Future of* Series:

The Future of Nuclear Power (2003)

The Future of Geothermal Energy (2006)

The Future of Coal (2007)

Update to the Future of Nuclear Power (2009)

The Future of Natural Gas (2011)

The Future of the Nuclear Fuel Cycle (2011)

The Future of the Electric Grid (2011)



**Energy Initiative
Massachusetts Institute of Technology**

Copyright © 2015 Massachusetts Institute of Technology.

All rights reserved.

Incorporated in the cover art is an image of the Gemasolar solar thermal plant,
owned by Torresol Energy. ©SENER

ISBN (978-0-928008-9-8)

Study Participants

STUDY CHAIR

RICHARD SCHMALENSSEE

Howard W. Johnson Professor of Economics and Management
John C. Head III Dean (Emeritus)
Sloan School of Management, MIT

STUDY CO-CHAIR

VLADIMIR BULOVIĆ

Fariborz Maseeh (1990) Professor of Emerging Technology
Associate Dean of Innovation
Electrical Engineering and Computer Science, MIT

STUDY GROUP

ROBERT ARMSTRONG

Chevron Professor, Department of Chemical Engineering, MIT
Director, MIT Energy Initiative

CARLOS BATLLE

Visiting Scholar, MIT Energy Initiative
Associate Professor, Institute for Research in Technology
Comillas Pontifical University

PATRICK BROWN

PhD Candidate, Department of Physics, MIT

JOHN DEUTCH

Institute Professor, Department of Chemistry, MIT

HENRY JACOBY

Professor (Emeritus), Sloan School of Management, MIT

ROBERT JAFFE

Morningstar Professor of Science, Department of Physics, MIT

JOEL JEAN

PhD Candidate, Department of Electrical Engineering and Computer Science, MIT

RAANAN MILLER

Associate Director, MIT Energy Initiative
Executive Director, Solar Energy Study*

FRANCIS O'SULLIVAN

Senior Lecturer, Sloan School of Management, MIT
Director, Research and Analysis, MIT Energy Initiative

JOHN PARSONS

Senior Lecturer, Sloan School of Management, MIT

JOSÉ IGNACIO PÉREZ-ARRIAGA

Professor, Institute for Research in Technology
Comillas Pontifical University
Visiting Professor, Engineering Systems Division, MIT

NAVID SEIFKAR

Research Engineer, MIT Energy Initiative

ROBERT STONER

Deputy Director for Science and Technology, MIT Energy Initiative
Director, Tata Center for Technology and Design, MIT

CLAUDIO VERGARA

Postdoctoral Associate, MIT Energy Initiative

*Also a contributing author.

CONTRIBUTING AUTHORS

REJA AMATYA

Research Scientist, MIT Energy Initiative

FIKILE BRUSHETT

Assistant Professor, Department of
Chemical Engineering, MIT

ANDREW CAMPANELLA

SDM Candidate, Engineering Systems Division, MIT

GÖKŞİN KAVLAK

PhD Candidate, Engineering Systems Division, MIT

JILL MACKO

PhD Candidate, Department of Materials Science
and Engineering, MIT

ANDREA MAURANO

Postdoctoral Associate, Organic and Nanostructure
Electronics Laboratory

JAMES McNERNEY

Postdoctoral Associate, Engineering Systems
Division, MIT

TIMOTHY OSEDACH

PhD Candidate, Department of Applied Physics,
Harvard

PABLO RODILLA

Research Scientist, Institute for Research in Technology
Comillas Pontifical University

AMY ROSE

PhD Candidate, Engineering Systems Division, MIT

APURBA SAKTI

Postdoctoral Associate, Department of
Chemical Engineering, MIT

EDWARD STEINFELD

Visiting Professor, Department of Political
Science, MIT

JESSIKA TRANCIK

Atlantic Richfield CD Assistant Professor in Energy
Studies, Engineering Systems Division, MIT

HARRY TULLER

Professor, Department of Materials Science
and Engineering, MIT

STUDENTS AND RESEARCH ASSISTANTS

CARTER ATLAMAZOGLU

KEVIN BERKEMEYER

RILEY BRANDT

ARJUN GUPTA

ANISA MCCREE

RICHARD O'SHEA

PIERRE PRIMARD

JENNIFER RESVICK

JASON WHITTAKER

These affiliations reflect the affiliation of the authors at the time of their contributions.

Advisory Committee Members

PHILIP SHARP – CHAIRMAN

President, Resources for the Future

ARUNAS CHESONIS

CEO and Chairman of the Board, Sweetwater Energy Inc.

PHILIP DEUTCH

Managing Partner, NGP Energy Technology Partners, LP

DAVID GOLDWYN

President, Goldwyn Global Strategies, LLC

NATHANAEL GREENE

Director Renewable Energy Policy, New York City,
Energy and Transportation Program
Natural Resources Defense Council

ANDY KARSNER

CEO, Manifest Energy Inc.

ELLEN LAPSON

Principal, Lapson Advisory

NATE LEWIS

George L. Argyros Professor of Chemistry,
California Institute of Technology

ARUN MAJUMDAR

Jay Precourt Professor, Senior Fellow, Stanford University

ROBERT MARGOLIS

Senior Energy Analyst, National Renewable Energy
Laboratory

GARY RAHL

Executive Vice President, Booz, Allen & Hamilton

DAN REICHER

Executive Director, Steyer-Taylor Center for Energy Policy
and Finance
Faculty Member, Stanford Law School and Graduate
School of Business, Stanford University

BRUCE SOHN

President, MEGE Associates

WILLIAM TUMAS

Associate Lab Director for Materials and Chemistry,
National Renewable Energy Laboratory

BERT VALDMAN

President and CEO, Optimum Energy

GREG WOLF

President, Duke Energy Renewables

While the members of the advisory committee provided invaluable perspective and advice to the study group, individual members may have different views on one or more matters addressed in the report. They are not asked to individually or collectively endorse the report findings and recommendations.



Table of Contents

Foreword and Acknowledgments	ix
Summary for Policymakers	xi
Executive Summary	xiii
Section I	
Chapter 1 – Introduction and Overview	1
Section II – Solar Technology	
Chapter 2 – Photovoltaic Technology	21
Chapter 3 – Concentrated Solar Power Technology	47
Section III – Business/Economics	
Chapter 4 – Solar PV Installations	77
Chapter 5 – Economics of Solar Electricity Generation	103
Section IV – Scaling and Integration	
Chapter 6 – PV Scaling and Materials Use	125
Chapter 7 – Integration of Distributed Photovoltaic Generators	153
Chapter 8 – Integration of Solar Generation in Wholesale Electricity Markets	175
Section V – Public Policy	
Chapter 9 – Subsidizing Solar Technology Deployment	209
Chapter 10 – Advancing Solar Technologies: Research, Development, and Demonstration	231

Appendices	
Appendix A – The Solar Resource	253
Appendix B – Photovoltaics Primer	271
Appendix C – Energy Storage Systems for the Electric Power Sector	285
Appendix D – Concentrated Solar Power Models and Assumptions	305
Appendix E – Methods and Assumptions Used in Chapter 5	313
Appendix F – Background Material for Chapter 8	317
Acronyms and Abbreviations	321
List of Figures	323
List of Tables	326
Glossary	327

Related Working Papers are available at <http://mitei.mit.edu/futureofsolar>

Foreword and Acknowledgments

This study is the seventh in the MIT Energy Initiative's "Future of" series, which aims to shed light on a range of complex and important issues involving energy and the environment. Previous studies in this series have focused on energy supply technologies that play important roles in electric power systems and on the electricity grid itself. In contrast, solar energy, the focus of this study, accounts for only about 1% of electricity generation in the United States and globally. We believe a focus on solar technologies is nonetheless warranted because, as we discuss at several points in this study, the use of solar energy to generate electricity at very large scale is likely to be an essential component of any serious strategy to mitigate global climate change.

We anticipate that this report will be of value to decision makers of diverse interests and expertise in industry and government as they guide the continuing evolution of the solar industry. Chapter 1 provides an overview of the solar resource and its potential role in the future energy mix, and introduces the remainder of the study. Subsequent chapters discuss the two fundamental solar generation technologies, photovoltaic and concentrated solar (or solar thermal) power, the economics of photovoltaic generation, the challenges of scaling up solar generation and integrating it into existing power systems, and changes that would improve the efficiency of U.S. policies aimed at advancing solar technologies and increasing their deployment. Appendices and related working papers document some of the analyses discussed in the chapters and provide more detailed information on photovoltaic and complementary technologies, and on the global photovoltaic supply chain.

The MIT *Future of Solar Energy Study* gratefully acknowledges the sponsors of this study:

The Alfred P. Sloan Foundation, The Arunas A. and Pamela A. Chesonis Family Foundation, Duke Energy, Edison International, The Alliance for Sustainable Energy, LLC, and Booz Allen Hamilton. In addition to providing financial support, a number of our sponsors gave us access to staff members who provided frequent and detailed information about technical and policy issues. We are very thankful for this cooperation.

The study development was guided by an Advisory Committee whose members dedicated a significant amount of their time to participate in multiple meetings, comment on our preliminary analysis, findings, and recommendations, and make available experts from their own organizations to answer questions and contribute to the content of the report. We would especially like to acknowledge the efficient conduct of Advisory Committee meetings under the able and experienced direction of the Committee's Chairman, Philip R. Sharp.

In addition to all of the valuable contributions from this study's sponsors, the Advisory Committee, and other members of their respective organizations, the research also benefited from the involvement of Joshua Linn and Gary DesGroseilliers, who served as Executive Directors for several years each in the initial and final stages of the project. We particularly want to thank Ernest J. Moniz, who deftly led this study as its co-Chairman until called to government service as Secretary of Energy in May 2013, and Joseph P. Hezir who served as the study's Executive Director until he joined Dr. Moniz at the Department of Energy in

June 2013. Neither Dr. Moniz nor Mr. Hezir had any involvement in any analysis or writing that occurred after they were asked to join the Administration, so they bear no responsibility for and do not necessarily agree with the study's final conclusions and recommendations.

This study was initiated and performed within the MIT Energy Initiative (MITEI). Professor Robert C. Armstrong has supported this study in his role as Director of MITEI and as an active

participant in the study group. MITEI staff provided administrative and financial management assistance to this project; we would particularly like to thank Rebecca Marshall-Howarth for helping to steward the production of this volume and associated working papers and Samantha Farrell for her assistance in facilitating our many meetings. Finally, we would like to thank Marika Tatsutani for editing this document with great skill and remarkable patience.

Summary for Policymakers

Massive expansion of solar generation worldwide by mid-century is likely a necessary component of any serious strategy to mitigate climate change. Fortunately, the solar resource dwarfs current and projected future electricity demand. In recent years, solar costs have fallen substantially and installed capacity has grown very rapidly. Even so, solar energy today accounts for only about 1% of U.S. and global electricity generation. Particularly if a substantial price is not put on carbon dioxide emissions, expanding solar output to the level appropriate to the climate challenge likely will not be possible at tolerable cost without significant changes in government policies.

The main goal of U.S. solar policy should be to build the foundation for a massive scale-up of solar generation over the next few decades.

Our study focuses on three challenges for achieving this goal: developing new solar technologies, integrating solar generation at large scale into existing electric systems, and designing efficient policies to support solar technology deployment.

TAKE A LONG-TERM APPROACH TO TECHNOLOGY DEVELOPMENT

Photovoltaic (PV) facilities account for most solar electric generation in the U.S. and globally. The dominant PV technology, used in about 90% of installed PV capacity, is wafer-based crystalline silicon. This technology is mature and is supported by a fast-growing, global industry with the capability and incentive to seek further improvements in cost and performance. In the United States, non-module or balance-of-system (BOS) costs account for some 65% of the price of utility-scale PV installations and about 85% of the price

of the average residential rooftop unit. Therefore, federal R&D support should focus on fundamental research into novel technologies that hold promise for reducing both module and BOS costs.

The federal PV R&D program should focus on new technologies, not — as has been the trend in recent years — on near-term reductions in the cost of crystalline silicon.

Today's commercial thin-film technologies, which account for about 10% of the PV market, face severe scale-up constraints because they rely on scarce elements. Some emerging thin-film technologies use Earth-abundant materials and promise low weight and flexibility. Research to overcome their current limitations in terms of efficiency, stability, and manufacturability could yield lower BOS costs, as well as lower module costs.

Federal PV R&D should focus on efficient, environmentally benign thin-film technologies that use Earth-abundant materials.

The other major solar generation technology is concentrated solar power (CSP) or solar thermal generation. Loan guarantees for commercial-scale CSP projects have been an important form of federal support for this technology, even though CSP is less mature than PV. Because of the large risks involved in commercial-scale projects, this approach does not adequately encourage experimentation with new materials and designs.

Federal CSP R&D efforts should focus on new materials and system designs, and should establish a program to test these in pilot-scale facilities, akin to those common in the chemical industry.

PREPARE FOR MUCH GREATER PENETRATION OF PV GENERATION

CSP facilities can store thermal energy for hours, so they can produce dispatchable power. But CSP is only suitable for regions without frequent clouds or haze, and CSP is currently more costly than PV. PV will therefore continue for some time to be the main source of solar generation in the United States. In competitive wholesale electricity markets, the market value of PV output falls as PV penetration increases. This means PV costs have to keep declining for new PV investments to be economic. PV output also varies over time, and some of that variation is imperfectly predictable. Flexible fossil generators, demand management, CSP, hydro-electric facilities, and pumped storage can help cope with these characteristics of solar output. But they are unlikely to prove sufficient when PV accounts for a large share of total generation.

R&D aimed at developing low-cost, scalable energy storage technologies is a crucial part of a strategy to achieve economic PV deployment at large scale.

Because distribution network costs are typically recovered through per-kilowatt-hour (kWh) charges on electricity consumed, owners of distributed PV generation shift some network costs, including the added costs to accommodate significant PV penetration, to other network users. These cost shifts subsidize distributed PV but raise issues of fairness and could engender resistance to PV expansion.

Pricing systems need to be developed and deployed that allocate distribution network costs to those that cause them, and that are widely viewed as fair.

ESTABLISH EFFICIENT SUBSIDIES FOR SOLAR DEPLOYMENT

Support for current solar technology helps create the foundation for major scale-up by building experience with manufacturing and deployment and by overcoming institutional barriers. But federal subsidies are slated to fall sharply after 2016.

Drastic cuts in federal support for solar technology deployment would be unwise.

On the other hand, while continuing support is warranted, the current array of federal, state, and local solar subsidies is wasteful. Much of the investment tax credit, the main federal subsidy, is consumed by transaction costs. Moreover, the subsidy per installed watt is higher where solar costs are higher (e.g., in the residential sector) and the subsidy per kWh of generation is higher where the solar resource is less abundant.

Policies to support solar deployment should reward generation, not investment; should not provide greater subsidies to residential generators than to utility-scale generators; and should avoid the use of tax credits.

State renewable portfolio standard (RPS) programs provide important support for solar generation. However, state-to-state differences and siting restrictions lead to less generation per dollar of subsidy than a uniform national program would produce.

State RPS programs should be replaced by a uniform national program. If this is not possible, states should remove restrictions on out-of-state siting of eligible solar generation.

Executive Summary

Solar electricity generation is one of very few low-carbon energy technologies with the potential to grow to very large scale. As a consequence, massive expansion of global solar generating capacity to multi-terawatt scale is very likely an essential component of a workable strategy to mitigate climate change risk. Recent years have seen rapid growth in installed solar generating capacity, great improvements in technology, price, and performance, and the development of creative business models that have spurred investment in residential solar systems. Nonetheless, further advances are needed to enable a dramatic increase in the solar contribution at socially acceptable costs. Achieving this role for solar energy will ultimately require that solar technologies become cost-competitive with fossil generation, appropriately penalized for carbon dioxide (CO₂) emissions, with — most likely — substantially reduced subsidies.

This study examines the current state of U.S. solar electricity generation, the several technological approaches that have been and could be followed to convert sunlight to electricity, and the market and policy environments the solar industry has faced. Our objective is to assess solar energy's current and potential competitive position and to identify changes in U.S. government policies that could more efficiently and effectively support the industry's robust, long-term growth. We focus in particular on three preeminent challenges for solar generation: reducing the cost of installed solar capacity, ensuring the availability of technologies that can support expansion to very large scale at low cost, and easing the integration of solar generation into existing electric systems. Progress on

these fronts will contribute to greenhouse-gas reduction efforts, not only in the United States but also in other nations with developed electric systems. It will also help bring light and power to the more than one billion people worldwide who now live without access to electricity.

This study considers grid-connected electricity generation by photovoltaic (PV) and concentrated solar (or solar thermal) power (CSP) systems. These two technologies differ in important ways. A CSP plant is a single large-scale installation, typically with a generating capacity of 100 megawatts (MW) or more, that can be designed to store thermal energy and use it to generate power in hours with little or no sunshine. PV systems, by contrast, can be installed at many scales — from utility plants with capacity in excess of 1 MW to residential rooftop installations with capacities under 10 kilowatts (kW) — and their output responds rapidly to changes in solar radiation. In addition, PV can use all incident solar radiation while CSP uses only direct irradiance and is therefore more sensitive to the scattering effects of clouds, haze, and dust.

REALIZING SOLAR ENERGY'S TECHNICAL POTENTIAL

Photovoltaic Modules

The cost of installed PV is conventionally divided into two parts: the cost of the solar module and so-called balance-of-system (BOS) costs, which include costs for inverters, racking and installation hardware, design and installation labor, and marketing, as well as various regulatory and financing costs. PV technology

choices influence both module and BOS costs. After decades of development, supported by substantial federal research and development (R&D) investments, today's leading solar PV technology, wafer-based crystalline silicon (c-Si), is technologically mature and large-scale c-Si module manufacturing capacity is in place. For these reasons, **c-Si systems likely will dominate the solar energy market for the next few decades and perhaps beyond. Moreover, if the industry can substantially reduce its reliance on silver for electrical contacts, material inputs for c-Si PV generation are available in sufficient quantity to support expansion to terawatt scale.**

However, current c-Si technologies also have inherent technical limitations — most importantly, their high processing complexity and low intrinsic light absorption (which requires a thick silicon wafer). The resulting rigidity and weight of glass-enclosed c-Si modules contribute to BOS cost. **Firms that manufacture c-Si modules and their component cells and input materials have the means and the incentive to pursue remaining opportunities to make this technology more competitive through improvements in efficiency and reductions in manufacturing cost and materials use. Thus there is not a good case for government support of R&D on current c-Si technology.**

The limitations of c-Si have led to research into thin-film PV alternatives. Commercial thin-film PV technologies, primarily cadmium telluride (CdTe) and copper indium gallium diselenide (CIGS) solar cells, constitute roughly 10% of the U.S. PV market today and are already cost-competitive with silicon. **Unfortunately, some commercial thin-film technologies are based on scarce elements, which makes it unlikely that they will be able to achieve terawatt-scale deployment at reasonable cost.** The abundance of tellurium in Earth's crust, for example, is estimated to be only one-quarter that of gold.

A number of emerging thin-film technologies that are in the research stage today use novel material systems and device structures and have the potential to provide superior performance with lower manufacturing complexity and module cost. Several of these technologies use Earth-abundant materials (even silicon in some cases). **Other properties of some new thin-film technologies, such as low weight and compatibility with installation in flexible formats, offer promise for enabling reductions in BOS costs along with lower module costs.**

Though these emerging technologies are not nearly competitive with c-Si today, they have the potential to significantly reduce the cost of PV-generated electricity in the future. And while the private sector is likely to view R&D investments in these technologies as risky, the payoff could be enormous. Therefore, **to increase the contribution of solar energy to long-term climate change mitigation, we strongly recommend that a large fraction of federal resources available for solar research and development focus on environmentally benign, emerging thin-film technologies that are based on Earth-abundant materials.** The recent shift of federal dollars for solar R&D away from fundamental research of this sort to focus on near-term cost reductions in c-Si technology should be reversed.

Concentrated Solar Power

CSP systems could be deployed on a large scale without encountering bottlenecks in materials supply. Also, the ability to include thermal energy storage in these systems means that CSP can be a source of dispatchable electricity. The best prospects for improving CSP economics are likely found in higher operating temperatures and more efficient solar energy collection. Therefore **R&D and demonstration expenditures on CSP technology should focus on advances in system design, including single-focus systems such as solar towers, and in the**

underlying materials science, that would allow for higher-temperature operations, and on the development of improved systems for collecting and receiving solar energy.

Historically, U.S. federal government support for CSP technology has included loan guarantees for commercial-scale installations. CSP plants only make economic sense at large scale and, given the technical and financial risks, investors in these large installations are naturally conservative in their selection of system designs and component technologies. Missing in federal efforts to promote CSP technology has been support for pilot-scale plants, like those common in the chemical industry, that are small enough to allow for affordable higher-risk experimentation, but large enough to shed light on problems likely to be encountered at commercial scale. Therefore **we recommend that the U.S. Department of Energy establish a program to support pilot-scale CSP systems in order to accelerate progress toward new CSP system designs and materials.**

THE PATH TO COST COMPETITIVENESS

PV Deployment

As of the end of 2014, PV systems accounted for over 90% of installed U.S. solar capacity, with about half of this capacity in utility-scale plants and the balance spread between residential and commercial installations. The industry has changed rapidly. In the past half-dozen years, U.S. PV capacity has expanded from less than 1,000 MW to more than 18,000 MW. Recent growth has been aided in part by a 50%–70% drop in reported PV prices (without federal subsidies) per installed peak watt. (The peak watt rating of a PV module or system reflects its output under standard test conditions of irradiance and temperature.) Almost all of this improvement has reflected falling prices for modules and inverters. In addition, the market structure for solar energy is changing, particularly at the residential level, with the

evolution of new business models, the introduction of new financing mechanisms, and impending reductions in federal subsidies.

Currently, the estimated installed cost per peak watt for a residential PV system is approximately 80% greater than that for a utility-scale plant, with costs for a typical commercial-scale installation falling somewhere in between. Module costs do not differ significantly across sectors, so the major driver of cost differences in different market segments is in the BOS component, which accounts for 65% of estimated costs for utility-scale PV systems, but 85% of installed cost for residential units. Experience in Germany suggests that several components of BOS cost, such as the cost of customer acquisition and installation labor, should come down as the market matures. Costs associated with permitting, interconnection, and inspection (PII) may be more difficult to control: across the United States, thousands of municipal and state authorities and 3,200 organizations that distribute electricity to retail customers are involved in setting and enforcing PII requirements. **A national or regional effort to establish common rules and procedures for permitting, interconnection, and inspection could help lower the PII component of installed system cost, particularly in the residential sector and perhaps in commercial installations as well.**

In the past few years, the nature of the residential solar business in the United States has changed appreciably. A third-party ownership model, which is currently allowed in half the states, is displacing direct sales of residential PV systems by enabling homeowners to avoid up-front capital costs. **The development of the third-party ownership model has been a boon to residential PV development in the United States, and residential solar would expand more rapidly if third-party ownership were allowed in more states.**

Today the estimated cost for a utility-scale PV installation closely matches the average reported price per peak watt, indicating active competition in the utility segment of the PV market. However, **a large difference exists between contemporary reported prices and estimated costs for residential PV systems, indicating that competition is less intense in this market segment.**

Two influences on PV pricing are peculiar to the U.S. residential market and to the third-party ownership model. One is the effect of current federal tax subsidies for solar generation: a 30% investment tax credit (ITC) and accelerated depreciation for solar assets under the Modified Accelerated Cost Recovery System (MACRS). Third-party owners of PV systems generally need to operate on a large scale to realize the value of these provisions, which creates a barrier to entry. In addition, because there is generally little price competition between third-party installers, PV developers often are not competing with one another to gain residential customers, but with the rates charged by the local electric distribution company.

Some of the largest third-party solar providers operate as vertically integrated businesses, and their systems are not bought and sold in “arm’s-length” transactions. Instead, for purposes of calculating federal subsidies they typically can choose to estimate their units’ fair market value based on the total income these units will yield. **In a less than fully competitive market, this estimation approach can result in fair market values that exceed system costs and thus lead to higher federal subsidies than under a direct sale model. Where competition is not intense, subsidies are not necessarily passed on to the residential customer.**

Over time, more intense competition in the residential PV market (as a natural consequence of market growth and the entry of additional suppliers) should direct more of the available subsidy to the residential customer by driving down both power purchase rates under third-party contracts and prices in direct sales. And these pressures will also intensify industry efforts to reduce the BOS component of installation cost.

Even with greater competition, however, an inherent inefficiency in the current, investment-based federal subsidy system will remain. Because residential solar has a higher investment cost per peak watt, and because the magnitude of the federal subsidy is based on a provider-generated calculation of fair market value, residential solar receives far higher subsidies per watt of deployed capacity than utility-scale solar. Moreover, because third-party contracts are influenced by local utility rates, which vary considerably across the country, the per-watt subsidy for identical residential or commercial installations can differ substantially from region to region.

Solar Economics

The economic competitiveness of solar electricity relative to other generation technologies depends on its cost and on the value of its output in the particular power market in which it is sold. A commonly used measure for comparing different power sources is the levelized cost of electricity (LCOE). However, **LCOE is an inadequate measure for assessing the competitiveness of PV, or for comparing PV with CSP or conventional generation sources, because the value per kilowatt-hour (kWh) of PV generation depends on many features of the regional electricity market, including the level of PV penetration.** The more PV capacity is online in a given market, for instance, the less valuable is an increment of PV generation.

Utility-Scale Solar

Estimates of LCOE are nonetheless useful because they give a rough impression of the competitive position of solar at its current low level of penetration in the U.S. electricity supply mix. In assessing the economics of utility-scale solar generation, the appropriate point of comparison is with other utility-scale generating technologies, such as natural gas combined cycle (NGCC) plants. **Without a price on CO₂ emissions and without federal subsidies, current utility-scale PV electricity has a higher LCOE than NGCC generation in most U.S. regions, including in relatively sunny southern California.**

Because of the structure of current federal subsidies, a significant fraction of their value is consumed by the costs of accessing the tax equity market, since most developers lack sufficient profits to take full advantage of the ITC and MACRS on their own. **If, however, the ITC and MACRS were 100% effective (i.e., if solar generators could capture the full value of these subsidies without incurring any costs of accessing the tax equity market), utility-scale PV would be cost competitive on an LCOE basis with NGCC in California, though not in Massachusetts.** By creating other cash flows for current utility solar projects, state and local support policies have facilitated the spread of utility-scale PV to many U.S. regions where it would not otherwise be economic.

Designing CSP plants with thermal energy storage lowers LCOE and allows them to generate electricity during periods when it is most valuable, making them more competitive with other generation sources. Nevertheless, **utility-scale PV generation is around 25% cheaper than CSP generation, even in a region like southern California that has strong direct insolation. Utility-scale PV is about 50% cheaper than CSP in a cloudy or hazy region**

like Massachusetts. Even with 100% effective federal subsidies, CSP is not competitive with NGCC generation today.

Residential Solar

If solar generation is valued for its contribution at the system or wholesale level, and assuming that solar penetration causes no net increase in distribution costs (see below), **PV generation by residential systems is, on average, about 70% more costly than from utility-scale PV plants. Even in California, and even including 100% effective federal subsidies, residential PV is not competitive with NGCC generation on an LCOE basis.** The economics of commercial-scale PV installations fall between the polar cases of utility- and residential-scale installations. Lowering BOS costs to the levels more typical of PV installations in Germany would bring residential PV closer to a competitive position, but residential PV would still be more expensive than utility-scale PV or NGCC generation.

In most U.S. electricity distribution systems, generation by grid-connected residential PV systems is compensated under an arrangement known as net metering. In this regime, the owner of the residential PV installation pays the retail residential rate for electricity purchased from the local distribution utility and is compensated at this same rate for any surplus PV output fed back into the utility's network. Under these conditions, the commonly used investment criterion is *grid parity*, which is achieved when it is just as attractive to employ a rooftop PV system to meet part of the residential customer's electricity needs as it is to rely entirely on the local distribution company. The highest incremental retail electricity rates in California are well above the estimated LCOE of residential PV systems in southern California, even without accounting for federal subsidies. And **with the current combination**

of federal, state, and local subsidies, the price of residential PV has now fallen below the level needed to achieve grid parity in many jurisdictions that apply net metering.

INTEGRATION INTO EXISTING ELECTRIC SYSTEMS

Distributed Solar

Introducing distributed PV has two effects on distribution system costs. In general, line losses initially decrease as the penetration of distributed PV increases. However, **when distributed PV grows to account for a significant share of overall generation, its net effect is to increase distribution costs (and thus local rates).**

This is because new investments are required to maintain power quality when power also flows from customers back to the network, which current networks were not designed to handle. Electricity storage is a currently expensive alternative to network reinforcements or upgrades to handle increased distributed PV power flows.

In an efficient and equitable distribution system, each customer would pay a share of distribution network costs that reflected his or her responsibility for causing those costs. Instead, most U.S. utilities bundle distribution network costs, electricity costs, and other costs and then charge a uniform per-kWh rate that just covers all these costs. **When this rate structure is combined with net metering, which compensates residential PV generators at the retail rate for the electricity they generate, the result is a subsidy to residential and other distributed solar generators that is paid by other customers on the network.** This cost shifting has already produced political conflicts in some cities and states — conflicts that can be expected to intensify as residential solar penetration increases.

Because of these conflicts, robust, long-term growth in distributed solar generation likely will require the development of pricing systems that are widely viewed as fair and that lead to efficient network investment. Therefore, **research is needed to design pricing systems that more effectively allocate network costs to the entities that cause them.**

Wholesale Markets

CSP generation, when accompanied by substantial thermal energy storage, can be dispatched in power markets in a manner similar to conventional thermal or nuclear generation. Challenges arise, however, when PV generators are a substantial presence in wholesale power markets. In about two-thirds of the United States, and in many other countries, generators bid the electricity they produce into competitive wholesale markets. PV units bid in at their marginal cost of production, which is zero, and receive the marginal system price each hour. **In wholesale electricity markets, PV displaces those conventional generators with the highest variable costs. This has the effect of reducing variable generation costs and thus market prices. And, since the generation displaced is generally by fossil units, it also has the effect of reducing CO₂ emissions.**

This cost-reducing effect of increased PV generation, however, is partly counterbalanced by an increased need to cycle existing thermal plants as PV output varies, reducing their efficiency and increasing wear and tear. The cost impact of this secondary effect depends on the existing generation mix: it is less acute if the system includes sufficient gas-fired combustion turbines or other units with the flexibility to accommodate the “ramping” required by fluctuations in solar output. At high levels of solar penetration, it may even be

necessary to curtail production from solar facilities to reduce cycling of thermal power plants. Thus, **regulations that mandate the dispatch of solar generation, or a large build-out of distributed PV capacity that cannot be curtailed, can lead to increased system operating costs and even to problems with maintaining system reliability.**

In the long term, as the non-solar generation mix adjusts to substantial solar penetration with the installation of more flexible peaking capacity, the economic value of PV output can be expected to rise. Also, **net load peaks can be reduced — and corresponding cycling requirements on thermal generators can be limited — by coordinating solar generation with hydroelectric output, pumped storage, other available forms of energy storage, and techniques of demand management. Because of the potential importance of energy storage in facilitating high levels of solar penetration, large-scale storage technologies are an attractive focus for federal R&D spending.**

Whatever the structure of other generation assets in a power system, the penetration of PV on a commercial basis will be self-limiting in deregulated wholesale markets. At low levels of solar penetration, marginal prices for electricity on most systems tend to be higher in the daytime hours, when PV generation is available, than at night. As solar generation during the day increases, however, marginal prices during these peak-demand hours will fall, reducing the return to solar generators. **Even if solar PV generation becomes cost-competitive at low levels of penetration, revenues per kW of installed capacity will decline as solar penetration increases until a breakeven point is reached, beyond which further investment in solar PV would be unprofitable.** Thus significant cost reductions may be required to make PV competitive at the very substantial penetration levels envisioned in many low-CO₂ scenarios.

In systems with many hours of storage, such as systems that include hydroelectric plants with large reservoirs, this effect of solar penetration is alleviated. Since opportunities for new hydroelectric generation or pumped storage are limited, **the self-limiting aspect of solar generation — wherein high levels of penetration reduce solar’s competitiveness — further highlights the importance of developing economical multi-hour energy storage technologies as part of a broader strategy for achieving economical large-scale PV deployment.**

DEPLOYMENT OF CURRENT TECHNOLOGY

The motivations often cited to support subsidizing deployment of current solar technology range from short-term emissions reductions to job creation. In our view, however, the dominant objective should be to create the foundation for large-scale, long-term growth in solar electricity generation as a way to achieve dramatic reductions in future CO₂ emissions while meeting growing global energy demand, and secondarily to achieve this objective with the most effective use of public budgets and private resources. The least-cost way to promote solar deployment would be via one of several price-based policies that reward the output of solar generation according to its value to the electricity supply system. In the United States, however, the primary federal-level incentive for solar energy is a subsidy to investment in solar facilities, using a costly method — tax credits — to provide it. In addition, many U.S. cities and states subsidize investments in solar electricity generation through various grants, low-interest loans, and tax credits.

Subsidies for solar technologies would be much more effective per taxpayer dollar spent if they rewarded generation, not investment.

This change would correct the inefficiency in the current federal program, under which a

kWh generated by a residential PV system gets a much higher subsidy than a kWh generated by a nearby utility-scale plant and facilities receive higher subsidies per kWh, all else equal, the less insolation they receive.

At the time of this writing, the main federal solar subsidy — the investment tax credit — is scheduled to fall sharply at the end of 2016, with no plans for a replacement. Congress should reconsider this plan. Current policies have spurred increases in market scale, customer familiarity, and competition that are contributing to the solar industry's long-term prospects. **Particularly in the absence of a charge on CO₂ emissions, now is the wrong time to drastically reduce federal financial support for solar technology deployment. The federal investment tax credit should not be restored to its current level, but it should be replaced with an output-based subsidy.**

If Congress nonetheless restores an investment subsidy, **it should replace tax credits with direct grants, which are both more transparent and more effective.** Finally, if tax-based incentives are to be used to spur solar deployment, **the investment tax credit should be replaced with an instrument that avoids dependence on the tax equity market, such as master limited partnerships.**

Reforming some of the many mandates and subsidies adopted by state and local governments could also yield greater results for the resources devoted to promoting solar energy. In particular, **state renewable portfolio standard (RPS) requirements should be replaced by a uniform nationwide program. Until such a nationwide program is in place, state RPS policies should not restrict the siting of eligible solar generators to a particular state or region.**

A CLOSING THOUGHT

In the face of the global warming challenge, solar energy holds massive potential for meeting humanity's energy needs over the long term while cutting greenhouse gas emissions. Solar energy has recently become a rapidly growing source of electricity worldwide, its advancement aided by federal, state, and local policies in the United States as well as by government support in Europe, China, and elsewhere. As a result the solar industry has become global in important respects.

Nevertheless, while costs have declined substantially in recent years and market penetration has grown, major scale-up in the decades ahead will depend on the solar industry's ability to overcome several major hurdles with respect to cost, the availability of technology and materials to support very large-scale expansion, and successful integration at large scale into existing electric systems. Without government policies to help overcome these challenges, it is likely that solar energy will continue to supply only a small percentage of world electricity needs and that the cost of reducing carbon emissions will be higher than it could be.

A policy of pricing CO₂ emissions will reduce those emissions at least cost. But until Congress is willing to adopt a serious carbon pricing regime, the risks and challenges posed by global climate change, combined with solar energy's potential to play a major role in managing those risks and challenges, create a powerful rationale for sustaining and refining government efforts to support solar energy technology using the most efficient available policies.

Section I

Chapter 1 – Introduction and Overview

This study is one in a series of *Future of* studies produced by the MIT Energy Initiative that aim to provide useful references for decision-makers and balanced, fact-based recommendations to improve public policy, particularly in the United States.ⁱ Earlier studies in this series have considered the futures of nuclear power, coal, natural gas, and the electric grid — all major features in today’s energy landscape.

By comparison, solar energy is currently much less important. It accounts for only around 1% of global electricity generation and a smaller fraction of U.S. generation.ⁱ It nonetheless deserves serious attention today because solar energy may be called upon to play a much larger role in the global energy system by mid-century and because removing several important obstacles over the next several decades will greatly increase the likelihood that solar energy will be able to answer that call. Our aim in this study is to help decision-makers understand solar energy’s potential future importance, the obstacles that may prevent solar technologies from realizing that potential, and the elements of sound public policies that could reduce current obstacles.

Solar energy’s importance ultimately derives from the profound long-term threat posed by global climate change.ⁱⁱ Carbon dioxide (CO₂)

emissions from the combustion of fossil fuels account for by far the largest share of greenhouse gases that are causing climate change.⁵ Because CO₂ remains in the atmosphere for centuries,⁶ slowing the increase in the atmospheric concentration of CO₂ requires *reducing* global CO₂ emissions, which have been rising at an accelerating rate since the industrial revolution.ⁱⁱⁱ To reduce emissions while providing the energy services necessary to accommodate global economic growth, the ratio of CO₂ emissions to global energy use must be reduced substantially.

Solar energy may be called upon to play a much larger role in the global energy system by mid-century...

Solar energy has the potential to play a major role in achieving this goal. About two-thirds of CO₂ emissions from fossil fuels are associated with electricity generation, heating, and transportation.^{iv} We already know how to use solar energy to generate electricity with very low CO₂ emissions,^v and we know how to use electricity to provide heat and surface transportation services. Moreover, as we discuss further below, the solar resource is enormous, dwarfing both global energy consumption and the potential scales of other renewable energy sources.⁹ A plausible way to reduce global CO₂

ⁱThe International Energy Agency found that photovoltaic systems accounted for about 0.85% of world generation in 2013, estimated that they would account for at least 1.0% in 2014, and found the U.S. share substantially below 1.0% in 2013. These numbers neglect the contribution of concentrated solar power (CSP) systems, but these accounted for only about 3% of solar generating capacity at the end of 2013.^{2,3}

ⁱⁱA recent, detailed study of the impacts of climate change in the United States is Melillo, Richmond, and Yohe.⁴

ⁱⁱⁱSee, e.g., U.S. Energy Information Administration.⁷

^{iv}IEA statistic explicitly excludes household and industrial use of fossil fuels, an appreciable proportion of which involves heating.⁸

^vSome emissions are produced during the installation, maintenance, and decommissioning of solar generating facilities, but they are much lower than the life-cycle emissions associated with fossil fuel use.

emissions despite growth in energy consumption would be to increase dramatically the use of solar energy to generate electricity and to rely more on electricity for heating and transportation.

The International Energy Agency (IEA) recently modeled several scenarios in which, as part of a worldwide response to the risks of climate change, global energy-related CO₂ emissions are cut to less than half of 2011 levels by 2050. IEA assumed that emissions reductions would be implemented at least cost, but in perhaps the most interesting scenario, growth of nuclear power is constrained by non-economic factors.^{vi} In that scenario, global demand for electricity rises by 79% between 2011 and 2050, and wind, hydro, and solar supply 66% of global generation in 2050, with solar alone supplying 27%. If expansion of hydroelectric facilities were to be limited for environmental reasons, as is already the case in the United States and many other nations,^{vii} solar energy would need to play an even greater role in global electricity supply to enable significant CO₂ reductions.

The chapters that follow discuss in more detail three potential obstacles that could stand in the way of solar energy's playing a leading role in the future: cost, scaling, and intermittency. First, while the cost of solar electricity has declined dramatically in recent years and can be expected to decline further in the future, using solar energy to generate electricity is still more expensive, in many locations, than using available fossil-fueled technologies. As we note below, it has been argued that at least some of the recent cost reductions are not sustainable. On the other hand, solar energy is at an

artificial cost disadvantage because the users of fossil energy pay nothing for the damages caused by the emissions they produce.^{viii} Accordingly, we favor putting a price on those emissions, either directly through a carbon tax or indirectly through a cap-and-trade regime. Such a comprehensive, market-based policy would provide economy-wide incentives to reduce CO₂ emissions at the lowest possible cost.^{ix}

When the penetration of solar energy increases, however, the average value of solar electricity declines because market prices are depressed during the sunny hours when solar generation is greatest. This means that even where solar generation is competitive with fossil generation today, its cost will have to fall significantly for it to remain competitive at higher levels of penetration. Thus, unless the recent cost-reduction trajectory can be continued, it is difficult to imagine that the expense of switching from fossil fuels to solar energy at very large scale would be voluntarily borne by U.S. voters, let alone by the citizens of India, China, and other developing nations. And developing nations are driving the ongoing increase in global CO₂ emissions.¹⁴

Second, if solar energy is to become a leading source of electricity by mid-century, the solar industry and its supply chain must scale up dramatically. In the IEA scenario discussed above, for instance, solar electricity generation increases to more than 50 times its 2013 level by 2050.^x Some solar technologies in development and limited deployment rely on scarce materials; for such technologies, a scale-up of this magnitude is likely to be uneconomic. Fortunately, materials constraints do not

^{vi}The use of carbon capture and sequestration was also constrained, but that constraint had less impact.¹⁰

^{vii}Between 1979 and 2011, U.S. generating capacity increased by 86%, but hydroelectric capacity *declined* by 4.7%.¹¹

^{viii}See, for instance, Greenstone and Looney¹²

^{ix}For a detailed comparison of market-based policies with some regulatory alternatives, see Rausch and Karplus.¹³

^xAccording to the IEA, solar energy only accounted for 0.3% of global electricity generation in 2011, and 2050 solar generation in the scenario discussed above was about 164 times that level. The estimate in the text is derived from these numbers, taking solar electricity as about 0.9% of total generation in 2013, per Footnote i, and noting that global generation in 2013 was about 4.7% above its 2011 level.¹⁵

appear to be an issue for other emerging solar technologies or for the silicon-based technology that dominates the industry today.

Third, solar power at any location is *intermittent*: it varies over time in ways that are imperfectly predictable.^{xi} This characteristic is a major obstacle to the large-scale use of solar generation in many regions. Today's electric power systems must match generation with demand almost instantaneously. Since demand fluctuations are also imperfectly predictable, adding small amounts of solar generation creates no appreciable problems. But in a power system that is heavily dependent on solar energy, the intermittency of the solar resource will make the net load (the load that must be satisfied by nuclear, hydro, and fossil-fueled generation) more variable and less predictable. At levels of penetration well below those envisioned in the IEA scenario discussed above, most systems may be able to handle this increased variability by moving to more flexible fossil-fueled generators, by making demand more responsive to system conditions, and by making modest use of energy storage.^{xii} In most systems, however, higher levels of solar penetration will likely require the development of economical large-scale energy storage technologies.

SCOPE AND FOCUS OF THIS STUDY

This study considers only the two widely recognized classes of technologies for converting solar energy into electricity — photovoltaics (PV) and concentrated solar power (CSP), sometimes called solar thermal) — in their current and plausible future forms. Because energy supply facilities typically last several decades, technologies in these classes will

Future solar deployment will depend heavily on uncertain future market conditions and public policies — including but not limited to policies aimed at mitigating global climate change.

dominate solar-powered generation between now and 2050, and we do not attempt to look beyond that date. In contrast to some earlier *Future of* studies, we also present no forecasts — for two reasons. First, expanding the solar industry dramatically from its relatively tiny current scale may produce changes we do not pretend to be able to foresee today. Second, we recognize that future solar deployment will depend heavily on uncertain future market conditions and public policies — including but not limited to policies aimed at mitigating global climate change.

As in other studies in this series, our primary aim is to inform decision-makers in the developed world, particularly the United States. We concentrate on the use of grid-connected solar-powered generators to replace conventional sources of electricity. For the more than one billion people in the developing world who lack access to a reliable electric grid,¹⁷ the cost of small-scale PV generation is often outweighed by the very high value of access to electricity for lighting and charging mobile telephone and radio batteries. In addition, in some developing nations it may be economic to use solar generation to reduce reliance on imported oil, particularly if that oil must be moved by truck to remote generator sites. A companion working paper discusses both these valuable roles for solar energy in the developing world.^{18, xiii}

^{xi}Solar irradiance, a measure of power, is commonly measured in watts per square meter at an instant in time. Solar insolation is often measured in kilowatts per square meter, averaged over some period of time.

^{xii}The three Hawaiian Electric Companies recently filed plans of this sort with their regulator. The electric company for Oahu contemplates 29% of generation coming from solar technologies by 2030 along with 8% from wind.¹⁶ This plan relies only on currently available technologies and thus calls for only targeted deployment of battery storage because of its high cost.

^{xiii}See also REN21.¹⁹

Two other uses of solar energy not discussed in our text deserve mention. First, a companion paper discusses the use of solar energy to heat water directly.²⁰ This mature technology is widely deployed in areas with a favorable mix of high insolation, high prices for natural gas and electricity, and significant subsidies. Second, several approaches have been proposed to use solar energy to produce storable fuels without first generating electricity.^{21, 22, 23} A technology that could do this at an acceptable cost might be a valuable tool for reducing CO₂ emissions from transportation and, perhaps, from other sectors that presently depend on fossil fuels. Solar-to-fuels technologies could potentially also provide long-term, grid-scale energy storage for electricity generation. Unfortunately, no such technology is close to commercialization.

The next section provides a brief discussion of the solar resource, which is further discussed in Appendix A. Subsequent sections provide an overview of the remainder of this study.

The solar resource is massive by any standard.

THE SOLAR RESOURCE: SCALE & CHARACTERISTICS

As noted above, the solar resource is massive by any standard. Using current PV technology, solar plants covering only about 0.4% of the land area of the continental United States and experiencing average U.S. insolation over the course of a year could produce all the electricity the nation currently consumes. This is roughly half of the land area currently devoted to producing corn for ethanol, which contributes

just under 7% of the energy content of U.S. gasoline,²⁴ or about 4% of the combined areas of the Corn Belt states of Iowa, Illinois, Minnesota, Indiana, and Nebraska.^{xiv} Since some places in the continental United States receive as much as 80% more solar energy than others, much less land area would be required if generation sites were carefully chosen — although siting in only the sunniest locations would likely also increase the need for long-distance transmission.

At the global scale, the solar resource is broadly distributed. Where there are people, there is sunlight. Figure 1.1a shows a map of average solar intensity across the globe.²⁵ Figures 1.1b–g display histograms of land area, population, and average insolation as functions of latitude and longitude.²⁶ It is notable that insolation varies by no more than a factor of three among densely populated areas. Neither fossil fuel resources nor good sites for wind or hydroelectric generation are as broadly distributed.²⁷

Figure 1.1h shows average insolation and GDP per capita for the year 2011 in each country for which these data are available.^{28,29} Average insolation varies across a much smaller percentage range than GDP per capita, and the weak negative correlation between these two variables, as indicated by the figure, implies that poorer nations are generally not disadvantaged in their access to the solar resource.

^{xiv}Support for these assertions and more information on the solar resource in Appendix A.

Figure 1.1 Worldwide Distribution of the Solar Resource³⁷

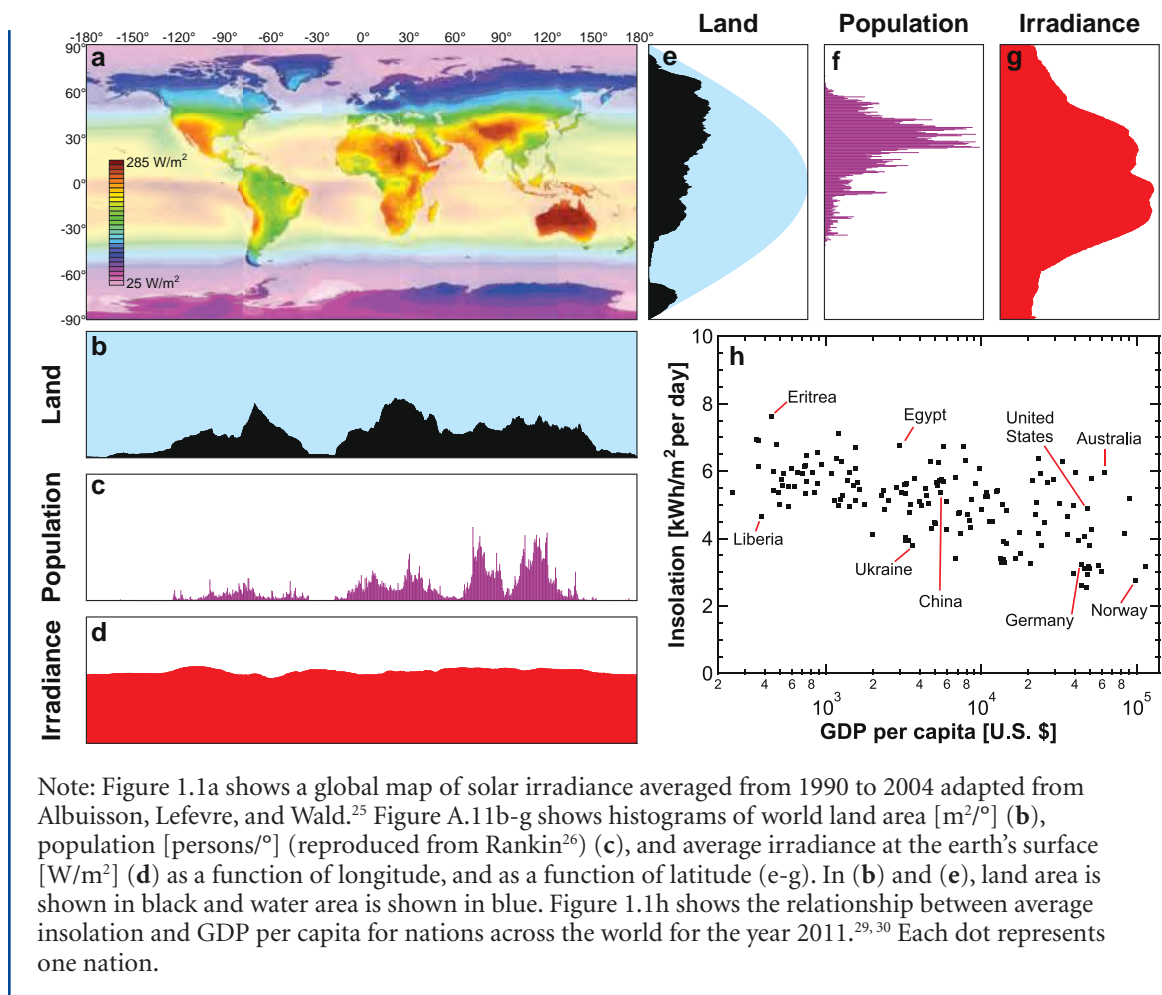

Note: Figure 1.1a shows a global map of solar irradiance averaged from 1990 to 2004 adapted from Albusison, Lefevre, and Wald.²⁵ Figure A.11b-g shows histograms of world land area [$\text{m}^2/^\circ$] (b), population [persons/ $^\circ$] (reproduced from Rankin²⁶) (c), and average irradiance at the earth's surface [W/m^2] (d) as a function of longitude, and as a function of latitude (e-g). In (b) and (e), land area is shown in black and water area is shown in blue. Figure 1.1h shows the relationship between average insolation and GDP per capita for nations across the world for the year 2011.^{29,30} Each dot represents one nation.

The massive scale of the solar resource and its broad distribution globally are consistent with solar energy becoming an important source, perhaps the leading source, of electricity generation worldwide. This study is motivated by the enormous potential of solar energy as a tool to reduce global CO_2 emissions and the great importance of effecting those reductions.

Within many countries and regions, the sunniest areas do not have the highest demand for electricity. In the United States, for instance, the desert Southwest is a great location for solar electricity generation but it is relatively sparsely populated. By contrast, the Northeast has a high demand for electricity per square mile but

This study is motivated by the enormous potential of solar energy as a tool to reduce global CO_2 emissions and the great importance of effecting those reductions.

relatively less insolation. Within the EU, there is considerably more sunlight in the south than in the north, but not more demand for electricity. Such geographical mismatches between sunlight and electricity demand create trade-offs in siting decisions: using sunny locations remote from major loads to reduce generation costs will require building long transmission lines to connect generation to those loads. Long transmission lines are expensive and, in many parts of the world, very difficult to site because of public objections.^{xv}

^{xv}For a discussion of transmission line siting in the U.S., see Kassakian and Schmalensee³¹

The difficulties of integrating large-scale solar generation into electric power systems derive from a fundamental characteristic of the solar resource: its intermittency.

As noted above, the difficulties of integrating large-scale solar generation into electric power systems derive from a fundamental characteristic of the solar resource: its *intermittency*. That is, the solar energy received in any particular place varies over time, and some of that variation — the part not associated with time of day and season of the year — cannot be perfectly predicted.

To illustrate the intermittency of the solar resource, Figure 1.2 displays the minute-to-minute solar intensity measured at the U.S. National Renewable Energy Laboratory (NREL) in Golden, Colorado, over the entire year 2012 (including night-time hours).³¹ Numerous patterns are visible that would be present at any location in any year. The most obvious pattern is the perfectly predictable diurnal variation: the sun is on average brightest at midday and never shines at night. There

is also a predictable northern hemispheric seasonal pattern. Following a particular day of the month downward through the chart, peak and total daily solar energy increase on average moving into the summer, after which they decrease moving into the winter.

In a power system that is highly reliant on solar energy, it follows from Figure 1.2 that the ability to store energy economically for several hours to meet night-time demand for electricity would be valuable, as would the ability to store energy at moderate cost from summer to winter. CSP facilities can often economically store heat for several hours and use it to generate electricity in later periods with little or no sunshine. But, as we note below and as Chapter 5 illustrates, CSP is much more expensive than PV in many locations.

Longer-term energy storage presents an even greater challenge.^{xvi} As discussed in Appendix C, batteries that could provide economical, large-scale electricity storage are currently unavailable for widespread deployment and may not be available in the near future.^{xvii}

Figure 1.2 Complete Solar Irradiance Profile in Golden, Colorado for the Year 2012

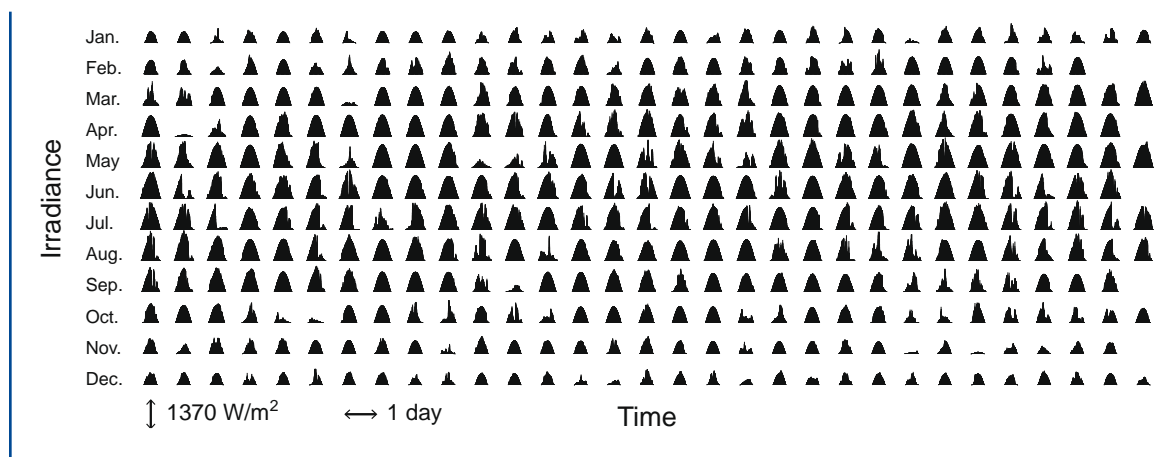

The time axis is to scale (nights are included).

^{xvi}Hydroelectric facilities that involve reservoirs (as opposed to so-called run-of-the-river hydro plants) as well as pumped storage plants (in which water is pumped uphill to a reservoir, from which it is later allowed to flow downhill through a turbine to generate electricity) already provide some large-scale storage that could be utilized seasonally. But suitable sites for such facilities are quite limited in most regions.

^{xvii}See also Cook, Dogutan, Reece, et al.²²

An alternative approach to large-scale, long-term storage involves using solar or other electricity to split water into hydrogen and oxygen via electrolysis when electricity is not valuable, and then using the hydrogen to generate electricity when electricity is more valuable. While about 5% of hydrogen is currently produced by electrolysis, this approach to energy storage is not yet economical.^{xviii} It is worth noting that an alternative to seasonal storage in a power system with very heavy reliance on solar energy would be to build sufficient solar capacity to meet winter-time demand, recognizing that it would likely be necessary to curtail some solar generation during other seasons.

Figure 1.2 also shows that within and between days, rapid and relatively unpredictable variations in irradiance can arise from shifting cloud cover. On September 1, for example, solar intensity dropped by a factor of four from 12:28 pm to 12:30 pm as a result of passing clouds. The month of July is characterized by sharp afternoon reductions in solar intensity caused by the frequent afternoon thunderstorms that occur in the vicinity of Golden, Colorado. Strong day-to-day variations are also visible. For example, the integrated 24-hour insolation values for the first and second days of April differ by a factor of 15, and some overcast weather systems, as seen from the 4th to the 6th of October, persist for several days.

In PV facilities, power output responds quickly to changes in irradiance, so these rapid variations may cause problems for power systems with high levels of PV penetration (that is, at penetration levels well above those in the United States today).^{xix} As illustrated in Appendix A, when grid-connected PV facilities are dispersed spatially, their total output is less affected by cloud-related variations. Exploiting this effect may require construction of new transmission facilities, of course. Large-scale energy storage could, when available, enhance the ability of power systems to deal with relatively short-term fluctuations in solar

Within and between days, rapid and relatively unpredictable variations in irradiance can arise from shifting cloud cover.

irradiance. Supply intermittency could also be addressed by making demand more responsive to system conditions (most naturally via prices that reflect those conditions), by curtailing solar generation when its output is excessive, and by adding more conventional generation that can vary output rapidly.^{xx}

SOLAR TECHNOLOGIES

Chapters 2 and 3 describe the two solar technology pathways that are the focus of this study: PV and CSP. At the end of 2013, more than 97% of global solar generation capacity was PV, and less than 3% was CSP.^{32, xxi}

^{xviii}The direct use of solar energy to produce fuel that could serve as a storage medium appears to be even farther from widespread deployment. See Tuller,²¹ Cook, Dogutan, Reece, et al.,²² and Walter, Warren, McKone, et al.²³

^{xix}As noted below, the output of CSP plants is much less sensitive to high-frequency cloud-related changes in solar irradiance, but, as Chapter 5 illustrates, CSP is currently much less economic than PV in cloudy locations.

^{xx}The last mechanism is examined in detail in Chapter 8.

^{xxi}At the end of 2014, about 89% of U.S. solar generating capacity was PV.³³ In the IEA scenario discussed above, by 2050 this balance is projected to shift in favor of CSP: 16% of global electricity is projected to be generated by PV and 11% by CSP.²

The first modern solar cells were produced in 1954 and deployed in 1958 on a U.S. satellite.

PV technology is discussed in detail in Chapter 2. The first modern solar cells were produced in 1954 and deployed in 1958 on a U.S. satellite. Those early cells relied on the silicon-wafer-based approach that continues to dominate the industry today. Manufacturing techniques have progressed enormously since then, and the price of solar cells and modules (which consist of multiple connected solar cells) has fallen dramatically. As Figure 1.3 suggests, PV generators have no moving parts: when sunlight strikes a solar cell connected to an external circuit, a direct electric current (dc) flows. PV generating facilities include solar modules and inverters that convert direct current into grid-compatible alternating current (ac), as well as other electrical and structural components, such as wires and brackets. One key advantage of solar PV over conventional fossil-fueled or nuclear generation is its modularity: solar-to-electric power conversion efficiency is unaffected by scale, though cost per unit of

generating capacity is significantly lower for utility-scale installations (which generally have capacities measured in megawatts) than for residential systems (which typically have capacities measured in kilowatts).

While most PV cells made today are based on crystalline silicon, active research is underway to explore alternative designs and materials capable of reaching cost targets that are much more favorable than those anticipated for existing commercial technologies.^{xxii} In Chapter 2, we provide a classification scheme for new and existing PV technologies based on the complexity of their primary light-absorbing material. We further identify three characteristics that will almost certainly be shared by successful future PV technologies: higher efficiency, lower materials use, and improved manufacturability.

CSP technology, discussed in detail in Chapter 3, is much less widely deployed, even though the first CSP power station was built in Egypt in 1912–13 to run an irrigation system. Figure 1.4 shows the two CSP designs that have

Figure 1.3 Solar PV



^{xxiii}In addition to silicon-based solar cells, cells based on thin-film technologies are now commercially deployed. However, as we discuss below, it is unlikely that these commercial thin-film technologies can make a significant contribution to global electricity generation in the future because of materials scaling considerations.

Figure 1.4 Solar CSP



Parabolic Trough Concentrating Solar Collector at Kramer Junction, California
Source: NREL 2012a



Gemaspolar Solar Thermal Plant, owned by Torresol Energy
©SENER

been deployed at commercial scale to date. In the older parabolic trough design, mirrors focus solar radiation on a pipe through which a fluid such as oil or a molten salt is pumped. The heated fluid is then used to produce steam that drives a turbine connected to a generator. In the power-tower design, a field of mirrors focuses solar radiation on the top of a tower through which a fluid is pumped. Power-tower plants can operate at a higher fluid temperature than parabolic trough plants, which increases overall efficiency. In either design, the output of the generator at any point in time depends on the temperature of the fluid, which is relatively insensitive to short-term changes in solar irradiance.

As a practical matter, these two CSP technologies can only be used at large scale. In addition, because CSP systems can only use direct sunlight, not sunlight diffused by haze or cloud cover, their performance is more sensitive to cloudiness and haze than the performance of PV systems. On the other hand, CSP facilities can economically provide hours of (thermal) energy storage, thereby producing power in hours with little or no sunlight, and they can be economically designed to use natural gas to

supplement solar energy in a fully dispatchable hybrid configuration. Research on CSP is exploring ways to increase efficiency by attaining higher temperatures and by converting more of the incident solar energy into thermal energy.

BUSINESS MODELS & ECONOMICS

Chapters 4 and 5 of this study consider the factors that determine the cost and value of solar electricity. Chapter 4 discusses the determinants of capital costs for PV generating facilities and describes the business models being used to support PV installations in the United States, while Chapter 5 explores how facility capital costs, insolation, and other factors affect the cost of electricity generated by PV and CSP systems. We then go on to consider the value of solar electricity and its determinants.

PV modules are commodity products; current production is concentrated in China and Taiwan but is supported by a global supply chain.^{34,35} Inverters are also a commodity product, traded internationally. PV system prices at all scales have declined considerably in recent years mainly because of reductions in module and inverter prices. As Chapter 4 notes, there is

considerable debate, which we do not attempt to resolve, about the drivers behind this decline, and specifically about the importance of manufacturing improvements relative to Chinese government subsidies and excess capacity in the Chinese solar module industry.^{xxiii} To the extent that the latter two factors are important, some of the recent declines in module prices may not be sustainable.

Modules and inverters now account for less than a third of residential PV system costs and about half of the costs of utility-scale systems in the United States. Remaining costs have not declined substantially in recent years. They include the costs of wires, brackets, and other components; the cost of labor for facility installation and other functions; the cost of financing initial installations; and installer overhead costs and profits. (PV system costs other than module costs are generally called balance-of-system or BOS costs.) In the United States, utility-scale costs and overall prices are already constrained by intense supplier competition, but competition is much less intense in the residential marketplace. Chapter 4 shows that even though module and inverter costs are essentially identical in the United States and Germany, total U.S. residential system costs are substantially above those in Germany. We discuss possible explanations and some policy implications.

Chapter 4 describes variants of the third-party ownership model, in which a homeowner buys the electricity generated on her roof from the owner of the PV system. This business model removes the need for the homeowner to make an up-front investment. Coupled with net metering, which compensates residential PV generation at the retail price of electricity and thus at a level that is generally well above the utility's marginal cost,^{xxiv} and a variety of subsidies that also favor residential over utility-scale installations, the third-party ownership model has fueled rapid expansion of residential PV generation in the United States. As Chapter 4 discusses, however, the residential market is still immature, and consumers often lack information. The result seems to have been a focus on competition between PV and grid-supplied electricity at retail prices, not competition between vendors of PV-generated electricity.

Chapter 5 models the economics of PV and CSP generation using today's technologies in two U.S. locations (southern California and central Massachusetts). At the utility scale, in both locations the levelized cost of electricity (LCOE) from a CSP plant is higher than the LCOE from a PV plant, and levelized costs for both solar technologies are considerably higher than those of conventional fossil-fueled generators.^{xxv} These results are broadly consistent with

^{xxiii}In December 2014, the U.S. Department of Commerce announced that substantial tariffs would be imposed on PV modules from China and Taiwan based on findings of dumping and government subsidies.³⁶

^{xxiv}As we discuss in more detail in Chapter 9, net metering compensates residential generation at the retail price of electricity, while utility-scale generation is typically compensated at the wholesale price. Much of the difference between these prices reflects the (largely fixed) cost of the distribution system and, frequently, other regulated charges that are included in the retail price. The current design of distribution network charges enables owners of residential PV systems to reduce their contributions to covering the distribution system's costs.

^{xxv}LCOE is defined as the ratio of the present discounted value of a plant's lifetime costs divided by the present discounted value of its lifetime electricity production; without discounting LCOE would just be the ratio of total cost to total output. LCOE is useful for comparing the costs of dispatchable technologies, but, as discussed below and in more detail in Chapter 5, it is less useful in connection with intermittent generation technologies that have variable and imperfectly predictable output trajectories.

many other studies. The U.S. Energy Information Administration (EIA), for instance, recently published the LCOE estimates shown in Table 1.1 for new utility-scale generating plants coming on line in the United States in 2019.^{xxvi} The maximum and minimum values shown in the table reflect regional differences in delivered fuel prices and more substantial differences in available solar and wind energy. While a good deal of uncertainty necessarily attaches to these estimates, and while the EIA's estimates of solar costs have tended to be above those available from some other sources, it is notable that the minimum costs for solar PV and CSP in Table 1.1 are above the maximum costs for natural gas combined cycle plants and even onshore wind generators.

Chapter 5 also finds that levelized costs for residential PV are higher than for utility-scale PV because of much higher residential BOS costs in the United States.^{xxvii} In all cases analyzed for this study, the per-kWh costs of residential generation were just over 170% of estimated costs for utility-scale generation. The fact that residential PV generation is nonetheless growing rapidly reflects, to a significant extent, the much higher per-kWh subsidies it receives.

While we follow standard practice and use LCOE as a summary measure of cost, it is important to recognize that this measure is of limited value when applied to intermittent technologies like solar for which the timing of power output is not fully controllable. Because electricity tends to be more valuable (as measured by the spot price in organized wholesale electricity markets) during the day than at night, for instance, solar electricity is more valuable on average at current prices than electricity from a baseload nuclear plant that produces at a constant rate. Thus LCOE comparisons, which do not take spot price patterns into account, tend to under-value incremental solar electricity today. But current prices reflect very low levels of solar penetration. As Chapter 8 demonstrates, once the fraction of electricity generated from solar energy rises well above current levels, the price of electricity at times of high solar output will decline. Thus the average value of solar electricity — and the profitability of solar generators — will decline with increased solar penetration. Moreover, LCOE comparisons ignore any additional costs incurred at the level of the power system as a whole to accommodate significant increases in intermittent solar generation.

Table 1.1 Estimated LCOEs for New Generation Resources in 2019³⁷

	(2012\$ per MWh)		
	Minimum	Average	Maximum
Conventional Coal	87	96	114
Gas Combined Cycle	61	66	76
Onshore Wind	71	80	90
Solar PV	101	130	201
Solar CSP	177	243	388

^{xxvi}The ranges reflect regional differences in fuel costs and in wind and solar resources.³⁷

^{xxvii}In addition, residential roofs are not generally optimally oriented with respect to the sun. This reduces output per unit of capacity and thus raises LCOE.

Grid-connected solar electricity exists at scale in the United States today only because it is subsidized in a variety of ways.

It follows from the cost estimates discussed above, as well as from the fact that the U.S. government does not tax or cap CO₂ emissions from fossil fuel combustion, that grid-connected solar electricity exists at scale in the United States today only because it is subsidized in a variety of ways. Chapters 4 and 5 review the effects of the main federal subsidies on the private costs of solar electricity. These subsidies, which consist of accelerated depreciation and an investment tax credit against corporate profits taxes, cost the government a good deal more than they benefit solar facility owners.^{xxviii} This finding prompts our conclusion, in Chapter 9, that alternative subsidy regimes could be considerably more efficient. Together, federal tax subsidies reduce the private cost of solar electricity by about a third. State and local subsidies vary considerably, but in some cases contribute substantial additional reductions in private costs.

There are emerging technologies with considerable promise that use Earth-abundant materials and that could be deployed at large scale if their efficiency and stability could be dramatically improved.

SCALING & INTEGRATION

Chapters 6–8 of this study deal with issues that would arise if solar energy were to play a major role in electric power systems — specifically, issues of scaling and integration.

Chapter 6 provides a quantitative analysis of the materials-use and land-area requirements that would follow if solar energy were to account for a large share of global electricity production by mid-century. As the IEA scenario discussed above indicates, this would require a dramatic increase in solar generating capacity. Nonetheless, Chapter 6 suggests that the availability of commodity materials such as glass, concrete, and steel is unlikely to prove an important hindrance to PV expansion on this scale if today's commercial technologies are employed. And, provided reliance on silver for electrical contacts can be decreased, there seem to be no significant materials-related barriers to a dramatic increase in the deployment of crystalline silicon-based PV, today's dominant solar technology. It is important to note, however, that some thin-film PV technologies currently in use or under development rely on rare materials such as tellurium and indium. Increasing the usage of these materials far above current levels would increase their costs dramatically and perhaps prohibitively. This makes the corresponding technologies poor candidates for large-scale deployment — and thus relatively unattractive as targets for government research and development spending. On the other hand, as Chapter 2 indicates, there are emerging technologies with considerable promise that use Earth-abundant materials and that could be deployed at large scale if their efficiency and stability could be dramatically improved.

^{xxviii}As Chapter 4 discusses, this difference arises because developers of solar projects typically need to find a partner with sufficient profits to be able to utilize the investment tax credit, and the so-called tax equity market in which such deals are done is highly imperfect.

Chapter 7 analyzes the impact of connecting distributed PV generation to existing low-voltage electricity distribution systems. Having generation near demand reduces the use of the high-voltage transmission network and thus cuts the associated (resistive) losses of electric energy; proximity to load also reduces such losses in the distribution network (except at very high levels of penetration). But, as Chapter 7 demonstrates, when distributed generation accounts for a large share of the overall power mix, any savings from associated reductions in network losses are generally swamped by the cost of the distribution-system investments needed to accommodate power flows from facilities connected at the distribution level out to the rest of the grid. The magnitude of these investments depends on features of the local distribution system (e.g., population and load density) and on the characteristics of the local solar resource and its location in the network.

Chapter 8 reports on simulations that explore the impact of large-scale solar integration at the level of the wholesale power system, considering operations, planning, and wholesale electricity market prices. Our analysis focuses on the variability of solar output, not its imperfect predictability. An important finding is that incremental solar capacity, without storage, may have little or no impact on total requirements for non-solar capacity, because system peak demand may occur during late afternoon or early evening hours when there is low or no insolation, or even at night in the case of systems where annual peak load is not driven by air-conditioning.

Because solar PV has zero marginal cost, a substantial increase in solar PV penetration will tend to make existing plants with high marginal costs non-competitive in the wholesale electricity market. In addition, because

solar PV is intermittent, substantially increasing solar PV penetration will tend to increase the need for thermal plants to vary their output. This cycling of thermal plants can involve substantial cost increases. All else equal, a more flexible generation mix — in particular, one with more hydroelectric plants with reservoirs — will incur a smaller increase in cycling costs.

The coordination of solar energy production and storage, through thermal storage at CSP facilities or through other means, can also help reduce the need for thermal-plant cycling and thereby increase the value of solar generation.

At higher levels of PV penetration, it will be increasingly desirable to curtail solar production (and/or other zero-variable cost production) to avoid costly variation of thermal power plants' outputs and, in the long run, to shift the fleet of thermal generators toward more flexible technologies. The coordination of solar energy production and storage, through thermal storage at CSP facilities or through other means, can also help reduce the need for thermal-plant cycling and thereby increase the value of solar generation.

PUBLIC POLICY CHOICES

The final two chapters of this study consider government support for the development and deployment of solar technologies. Such support is generally justified as a response to two market failures: the *knowledge* spillovers associated with fundamental research and with experience gained through deployment, and the *environmental* spillovers associated with reductions in emissions of CO₂ and perhaps other pollutants that are not appropriately regulated or taxed.^{xxix}

^{xxix}As we discuss in Chapter 9, if total CO₂ emissions are capped, as they are in the European Union, subsidizing the deployment of solar or other renewable generation facilities raises the cost of satisfying the cap in the short run, though it may contribute to advancing solar technology and reducing institutional barriers to large-scale deployment in the longer run.

Other proposed justifications for supporting solar technologies are more difficult to rationalize as responses to market failures and are thus likely to support wasteful policies. In fact, policies that would restrict international trade in PV modules and other commodity products in order to aid domestic industry would raise the cost of using solar energy to reduce CO₂ emissions, thus hindering achievement of the key environmental objective.

Governments in the United States and abroad have devoted considerable resources to supporting the deployment of existing PV and CSP technologies and to funding research, development, and demonstration (RD&D) aimed at reducing the cost of solar electricity in the future. It is important to recognize, though, that in the United States and elsewhere, subsidies to solar are dwarfed by subsidies to other energy sources.^{xxx} Recommending what resources the U.S. government should devote to supporting solar technology deployment and RD&D rather than pursuing other public

and that future cost reductions will come primarily from efforts by manufacturers and installers, support for deployment becomes relatively more attractive. Alternatively, if one believes that RD&D on PV, CSP, and complementary technologies such as grid-level storage and solar-to-fuels technologies could produce dramatic reductions in the overall future cost of solar electricity, investment in RD&D becomes relatively more attractive.

While most members of the study team in fact favor a shift of some spending from deployment to RD&D, our analysis in Chapters 9 and 10 concentrates on how spending in each of these areas can be more efficient and effective.

If a price were imposed on U.S. CO₂ emissions to reflect the damages they cause, whether through a tax or a cap-and-trade regime, special support for the deployment of solar technologies would still be justified to the extent that such support served to advance those technologies and to overcome institutional and other barriers to large-scale deployment. Chapter 9 focuses on approaches that have been used in the United States and abroad to support solar technology deployment, including: 1) price-based policies, which affect the prices solar generators receive for their output; 2) output-based policies, which require minimum amounts of solar generation; 3) investment-based policies, which subsidize investment in solar generators; and 4) a variety of other policies that fit in none of these categories. In the United States, a wide array of support policies of all types has been and is being employed at the federal, state and local levels. What is not known, however, is how much has been spent in total by taxpayers and electricity consumers to support solar deployment.

The division of any given level of spending between deployment and RD&D should be heavily influenced by expectations about the determinants of long-term costs.

objectives would take us well beyond the bounds of this study. It should be noted, though, that if solar electricity will be called upon to play a much greater role by mid-century than it does today, the division of any given level of spending between deployment and RD&D should be heavily influenced by expectations about the determinants of long-term costs.^{xxxi} If, for instance, one expects that RD&D is unlikely to deliver significant breakthroughs

^{xxx}In the U.S. in fiscal 2010, for instance, direct federal subsidies to solar energy were less than those to each of coal, natural gas and petroleum liquids, nuclear, and wind and comparable to subsidies for biomass.³⁸

^{xxxi}For an illustration of this sort of choice, see Payne, Duke, and Williams.³⁹

Because, as noted above, residential PV generation in the United States is considerably more expensive than utility-scale generation, a dollar of subsidy devoted to residential PV generation produces less solar electricity than a dollar of subsidy devoted to utility-scale generation. For this reason, federal, state, and local policies that subsidize residential solar generation more generously than utility-scale solar generation make little sense. Chapter 9 also concludes that the U.S. federal investment tax credit is considerably less efficient than a variety of alternative price-based and output-based subsidies. At the state level, more than half the states have renewable portfolio standards (RPS) that generally require firms that sell electricity at retail to acquire specified minimum fractions of that electricity from generators that have been certified as renewable. More than half of these programs have explicit requirements for, or give extra incentives for, solar power or distributed generation (which is predominantly PV). Because all but two existing state RPS programs limit the ability to procure renewable power from distant sources, however, siting decisions for solar plants are constrained. This unnecessarily increases costs.

The last chapter of this study, Chapter 10, deals with RD&D spending aimed at improving solar technologies. Historically, the U.S. federal government has spent little on solar energy relative to other technologies with less long-run potential in a carbon-constrained world.^{xxxii} Moreover, the level of spending on solar RD&D has varied substantially over time, significantly reducing the efficiency of the research enterprise.

Chapter 10 argues that today's high cost of solar electricity relative to other generating technologies, plus the likely need for solar to play a much greater role in the global energy system in coming decades, implies that federal spending should focus on fundamental research aimed at

Federal, state, and local policies that subsidize residential solar generation more generously than utility-scale solar generation make little sense.

advances with the potential to substantially reduce costs and on applied research and exploratory development of promising emerging solar technologies, rather than on seeking incremental improvements of currently commercial technologies. Industry has both the means and the incentives to pursue incremental improvements. The importance of BOS costs in the overall cost of PV facilities implies that reducing those costs is at least as important as reducing module costs. Research on solar cells and modules should focus on emerging technologies that avoid rare materials and have low manufacturing costs, particularly those that could enable novel applications with low BOS costs. To reduce the very high current costs of CSP, Chapter 10 argues for research aimed at enabling operations at much higher temperatures than those typical of current CSP systems, as well as advances in the conversion of solar to thermal energy. In addition, fundamental research on solar-to-fuels technologies and grid-scale energy storage could produce important reductions in the overall costs of electric power from systems in which the sun is the dominant source of energy.

CONCLUDING REMARKS

The importance of mitigating climate change coupled with solar energy's potential to generate electricity with very low life-cycle CO₂ emissions at very large scale mean that solar energy technologies could play a critically important role in the global energy system by mid-century. But this will only be possible if the public and private sectors can overcome the three potential obstacles that we have mentioned in this introduction and that are discussed in more

^{xxxii}For detailed historical data on U.S. federal energy RD&D spending, see Gallagher and Anadon.⁴⁰

detail in subsequent chapters: it is generally more expensive at present to generate electricity from solar energy than from fossil fuels; the solar industry today is tiny relative to the scale it would need to attain to play a major role in the global energy system; and solar electricity is intermittent.

It seems possible with existing technologies to handle the intermittency of solar generation even at penetration substantially above current levels.

With respect to the first of these obstacles, RD&D on solar technologies has the potential to reduce their costs, perhaps substantially, and putting a price on CO₂ emissions through a tax or cap-and-trade system will level the playing field between solar and fossil technologies. Particularly before a comprehensive climate policy is in place, deployment subsidies can reduce emissions and provide incentives to lower various barriers to large-scale solar deployment, and may contribute to advancing solar technology. Second, as long as solar technologies that rely on scarce materials are used only to a limited extent, there are no visible obstacles to increasing the scale of solar generation dramatically. Finally, it seems possible with existing technologies to handle the intermittency of solar generation even at penetration substantially above current levels, using flexible fossil-fueled generators, reservoir hydro and pumped storage where available, and making increased use of demand response. RD&D that substantially reduces the cost of CSP generation, with its inherent storage capability, could help in some regions. In the longer run, advances that make grid-level energy storage economical may be required to enable very high levels of reliance on solar generation.

While we are optimistic about the potential contribution of solar RD&D, and thus about the potential of solar to make a much greater contribution to global energy supply than at present, we are critical of the current pattern of U.S. government support for solar technologies. The total amount currently being spent at all levels of government to support solar deployment is unknown, but it is clear that the policies that have been employed to date produce significantly less solar generation per dollar spent than they could. Spending on solar RD&D has been low relative to spending on other energy technologies with less long-term potential, it has been variable over time, and it has been too focused on short-term gains rather than long-term reductions in the cost of solar electricity. All of these aspects of public policy can and should be improved.

REFERENCES

- ¹“The Future of ...” Studies. MIT Energy Initiative. <http://mitei.mit.edu/publications/reports-studies/future>
- ²*PVPS Report: Snapshot of Global PV 1992-2013, Preliminary Trends Information from the IEA PVPS Programme*. International Energy Agency. Report IEA-PVPS T1-24:2014. (Mar 31, 2014). http://www.iea-pvps.org/index.php?id=92&eID=dam_frontend_push&docID=1924
- ³*Renewables 2014 Global Status Report*. REN21. (2014). http://www.ren21.net/Portals/0/documents/Resources/GSR/2014/GSR2014_full%20report_low%20res.pdf
- ⁴Melillo, J.M., T.C. Richmond, and G.W. Yohe, Eds. *Climate Change Impacts in the United States: The Third National Climate Assessment*. U.S. Global Change Research Program. (2014):841 http://s3.amazonaws.com/nca2014/low/NCA3_Climate_Change_Impacts_in_the_United%20States_LowRes.pdf?download=1
- ⁵*CO₂ Emissions from Fuel Combustion: Highlights, 2014 Edition*. International Energy Agency. (2014): 7. <http://www.iea.org/publications/freepublications/publication/CO2EmissionsFromFuelCombustionHighlights2014.pdf>
- ⁶Ciais, P. and C. Sabine. “Carbon and Other Biogeochemical Cycles.” *Climate Change 2013: The Physical Science Basis*. Intergovernmental Panel on Climate Change. (2013): 472-3. http://www.ipcc.ch/pdf/assessment-report/ar5/wg1/WG1AR5_Chapter06_FINAL.pdf
- ⁷“World Carbon Dioxide Emissions by Region.” *International Energy Outlook 2013*. U.S. Energy Information Administration. <http://www.eia.gov/oiaf/aeo/tablebrowser/#release=IEO2013&subject=0-IEO2013&table=10-IEO2013®ion=0-0&cases=Reference-d041117>
- ⁸*CO₂ Emissions from Fuel Combustion: Highlights, 2014 Edition*. International Energy Agency. (2014): 11. <http://www.iea.org/publications/freepublications/publication/CO2EmissionsFromFuelCombustionHighlights2014.pdf>
- ⁹Jacobson, M.Z., and M.A. Delucchi. “Providing All Global Energy with Wind, Water, and Solar Power, Part I: Technologies, Energy Resources, Quantities and Areas of Infrastructure, and Materials.” *Energy Policy* 39, no. 3 (2011): 1154-1169.
- ¹⁰*Energy Technology Perspectives 2014 - Harnessing Electricity's Potential*. International Energy Agency. (2014). <http://www.iea.org/etp/etp2014/>
- ¹¹“Electric Net Summer Capacity: Total (All Sectors), 1949-2011.” *Annual Energy Review*. U.S. Energy Information Administration. <http://www.eia.gov/totalenergy/data/annual/showtext.cfm?t=ptb0811a>
- ¹²Greenstone, M. and A. Looney. “Paying Too Much for Energy? The True Costs of our Energy Choices.” *Daedalus* 141, no. 2 (2012): 10-30. http://www.mitpressjournals.org/doi/abs/10.1162/DAED_a_00143#.VQWxp44Xc7k
- ¹³Rausch, S. and V.J. Karplus. *Markets Versus Regulation: The Efficiency and Distributional Impacts of U.S. Climate Policy Proposals*. MIT Joint Program on the Science and Policy of Global Change. (2014). <http://dspace.mit.edu/handle/1721.1/91460>
- ¹⁴*BP Energy Outlook 2035*. British Petroleum. (Jan 2014): 80. http://www.bp.com/content/dam/bp/pdf/Energy-economics/Energy-Outlook/Energy_Outlook_2035_booklet.pdf
- ¹⁵“Electricity.” *BP Statistical Review of World Energy 2014*. British Petroleum. (Jun 2014) <http://www.bp.com/content/dam/bp/pdf/Energy-economics/statistical-review-2014/BP-statistical-review-of-world-energy-2014-electricity-section.pdf>
- ¹⁶*Hawaiian Electric Power Supply Improvement Plan*. Hawaiian Electric Company. (Aug 26, 2014). http://files.hawaii.gov/puc/3_Dkt%202011-0206%202014-08-26%20HECO%20PSIP%20Report.pdf
- ¹⁷“Electricity Access Database.” *Energy Access Database*. International Energy Agency. (2014). [http://www.worldenergyoutlook.org/media/weowebpage/WEO2014Electricitydatabase\(1\).xlsx](http://www.worldenergyoutlook.org/media/weowebpage/WEO2014Electricitydatabase(1).xlsx)
- ¹⁸Rose, A., A. Campanella, R. Amaty, and R. Stoner. *Prospects for Solar Power in the Developing World*. Forthcoming MIT Future of Solar Energy study related publication. (2015). <http://mitei.mit.edu/futureofsolar>
- ¹⁹“Chapter 5: Distributed Renewable Energy in Developing Countries.” *Renewables 2014 Global Status Report*. REN21. (2014). http://www.ren21.net/Portals/0/documents/Resources/GSR/2014/GSR2014_full%20report_low%20res.pdf
- ²⁰Maurano, A., R. Amaty, V. Bulovic, R. Stoner. *Solar Heating for Residential and Industrial Processes*. Forthcoming MIT solar study related publication. (2015). <http://mitei.mit.edu/futureofsolar>
- ²¹Tuller, H. *Solar to Fuels Conversion Technologies*. Forthcoming MIT solar study related publication. (2015). <http://mitei.mit.edu/futureofsolar>

- ²²Cook, T.R., D.K. Dogutan, S.Y. Reece, et al. “Solar Energy Supply and Storage for the Legacy and Nonlegacy Worlds.” *Chemical Reviews* 110, no. 11 (2010): 6474-6502. <http://pubs.acs.org/doi/pdf/10.1021/cr100246c>
- ²³Walter, M.G., E.L. Warren, J.R. McKone, et al. “Solar Water Splitting Cells.” *Chemical Reviews* 110, no. 11 (2010): 6446-6473. <http://pubs.acs.org/doi/pdf/10.1021/cr1002326>
- ²⁴*Frequently Asked Questions: How much ethanol is in gasoline and how does it affect fuel economy?* U.S. Energy Information Administration. <http://www.eia.gov/tools/faqs/faq.cfm?id=27&t=10>
- ²⁵Albuisson, M., M. Lefevre, and L. Wald. *Averaged Solar Radiation 1990-2004*. Ecole des Mines de Paris. (2006) <http://www.herjulf.se/solar/averaged-solar-radiation.pdf>
- ²⁶Rankin, B. *Radical Cartography*. (2008) www.radicalcartography.net
- ²⁷Jacobson, M.Z., and M.A. Delucchi. “Providing All Global Energy with Wind, Water, and Solar Power, Part I: Technologies, Energy Resources, Quantities and Areas of Infrastructure, and Materials.” *Energy Policy* 39, no. 3 (2011): Figure 1. <http://www.sciencedirect.com/science/article/pii/S0301421510008645>
- ²⁸*Solar Resources By Class and Country*. National Renewable Energy Laboratory. OpenEI. <http://en.openei.org/datasets/dataset/solar-resources-by-class-and-country>
- ²⁹*World DataBank. World Development Indicators*. The World Bank. (Dec 18, 2013). <http://databank.worldbank.org/data/views/reports/tableview.aspx>
- ³⁰*Measurement and Instrumentation Data Center (MIDC)*. National Renewable Energy Laboratory. <http://www.nrel.gov/midc/>
- ³¹Kassakian, J. G. and R. Schmalensee. “Chapter 4: Transmission Expansion,” *The Future of the Electric Grid: An Interdisciplinary MIT Study*. Technical report, Massachusetts Institute of Technology. (2011). http://mitei.mit.edu/system/files/Electric_Grid_4_Transmission_Expansion.pdf
- ³²*Renewables 2014 Global Status Report*. REN21. (2014): 111-112. http://www.ren21.net/Portals/0/documents/Resources/GSR/2014/GSR2014_full%20report_low%20res.pdf
- ³³*U.S. Solar Market Insight 2014 Year in Review*. Solar Energy Industries Association. (March 10, 2015). <http://www.seia.org/research-resources/us-solar-market-insight>
- ³⁴Deutch, J. and E. Steinfeld. *A Duel in the Sun: The Solar Photovoltaics Technology Conflict between China and the United States*. A Report of the MIT Future of Solar Energy Study. (May 15, 2013). <http://mitei.mit.edu/system/files/201305-futureofsolar-SunDuel.pdf>
- ³⁵*Renewables 2014 Global Status Report*. REN21. (2014): 48. http://www.ren21.net/Portals/0/documents/Resources/GSR/2014/GSR2014_full%20report_low%20res.pdf
- ³⁶Bradsher, K. “China Criticizes Steep U.S. Tariffs on Solar Panels,” *New York Times*. (Dec 18, 2014). <http://www.nytimes.com/2014/12/18/business/energy-environment/china-criticizes-steep-us-tariffs-on-solar-panels.html>
- ³⁷“Levelized Cost and Levelized Avoided Cost of New Generation Resources in the Annual Energy Outlook 2014,” *Annual Energy Outlook 2014*. U.S. Energy Information Administration. (Apr 17, 2014). http://www.eia.gov/forecasts/aeo/electricity_generation.cfm
- ³⁸Direct Federal Financial Interventions and Subsidies in Energy in Fiscal Year 2010. U.S. Energy Information Administration. (Jul, 2011). <http://www.eia.gov/analysis/requests/subsidy/archive/2010/pdf/subsidy.pdf>
- ³⁹Payne, A., R. Duke, and R.H. Williams. “Accelerating Residential PV Expansion: Supply Analysis for Competitive Electricity Markets.” *Energy Policy* 29, no. 10 (2001): 787-800. <http://www.sciencedirect.com/science/article/pii/S0301421501000143>
- ⁴⁰Gallagher, K.S. and L.D. Anadon. “DOE Budget Authority for Energy Research, Development, & Demonstration Database.” Harvard Kennedy School. (Mar 2014). http://belfercenter.ksg.harvard.edu/publication/24065/doe_budget_authority_for_energy_research_development_demonstration_database.html

The hyperlinks in this document were active as of April 2015.

Section II – Solar Technology

INTRODUCTION

This section describes the two solar-to-electricity (solar power) technologies that are the primary focus of this study: photovoltaics (PV) and concentrated solar power (CSP). Solar PV is the leading solar electric technology today, constituting 98% of global solar generation capacity in 2013;ⁱ the remainder is CSP. PV cells convert sunlight directly into electricity, whereas CSP technologies convert sunlight first to heat and then to electricity.

Chapter 2 describes the basics of PV generation and reviews PV technology options, including both established silicon-based technologies and newer alternatives. The chapter also discusses technological characteristics that are important for different PV applications, as well as current technology trends and directions for further research and development. Chapter 3 likewise describes the basics of CSP generation and current system designs and reviews the major technological challenges and other factors that will affect the deployment potential of various CSP options.

Chapter 2 highlights a number of advantages of PV power generation. A large PV installation is constructed by replicating many individual modules, so that scale-up and performance are highly predictable. This enables PV to be deployed today for power generation at many scales — from large utility plants to rooftop installations and even smaller units. Thus, PV can be used for either central or distributed power generation. Because solar PV cells harvest both direct and diffuse sunlight, they can operate under hazy or cloudy conditions. However, some PV technologies require rare or low-production-volume materials that may limit long-term scalability. At high levels of PV penetration in the overall electricity supply mix, external energy storage will be needed to mitigate the impacts of solar intermittency on grid reliability (discussed in detail in Chapters 7 and 8 and Appendix A).

CSP is deployed similarly to conventional thermal power plants, with thermal energy harvested from a mirror field used to drive a turbine that generates electricity. This characteristic allows CSP plants to easily and cheaply incorporate thermal energy storage, and it also allows for hybridization with fossil-fuel generators. These features can make solar electricity from CSP dispatchable, increase the annual capacity factor of the plant, and might help provide a transition path from fossil fuel to solar power generation. The use of turbines to generate electricity also means that CSP is deployed at utility scale and does not have the flexibility of scale that PV enjoys. Finally, CSP requires direct solar radiation and is not useful in regions with cloudy or hazy skies. This limits the areas where CSP can feasibly be deployed, though there is very large solar resource in those regions.

ⁱREN21. 2014. *Renewables 2014 Global Status Report* (Paris: REN21 Secretariat). 49, 51.

The technology trends sections of Chapters 2 and 3 describe promising R&D opportunities that could produce significant performance improvements and cost reductions for PV and CSP technologies. Critical areas of focus for PV technology innovation center on achieving higher power conversion efficiencies, lower materials usage, and reduced manufacturing complexity and cost. Critical areas of focus for CSP technology innovation include more efficient and low-cost heat collection systems, novel system designs, and improved materials and technologies for thermal energy storage.

Chapter 2 – Photovoltaic Technology

Solar photovoltaics (PV) are the most widely deployed solar electric technology in the world today. Fueled by light, solar cells operate near ambient temperature, with no moving parts, and they enable generation at any scale:

A 10-square-meter (m^2) PV array is in theory no less efficient per unit area than a 10-square-kilometer (km^2) array. This contrasts with other generation pathways, such as thermal generators or wind turbines, which lose efficiency with reduced scale.

This chapter reviews current PV technologies and identifies key strengths and remaining technical challenges associated with each.ⁱ Subsequent sections explore current application areas for PV modules and define the performance metrics that can be expected to drive deployment for each application. From these metrics, three primary technological trends can be identified that will be crucial for enabling large-scale PV deployment in any application area: higher power conversion efficiencies, lower materials usage, and reduced manufacturing complexity and cost.

2.1 BASICS OF SOLAR PV ENERGY CONVERSION

A solar PV array consists of one or more electrically connected PV modules — each containing many individual solar cells — integrated with balance-of-system (BOS) hardware components, such as combiner boxes, inverters, transformers, racking, wiring, disconnects, and enclosures. Figure 2.1 shows a complete solar PV system along with cross sections of a module and a cell. In a grid-connected system, combiners, inverters, and transformers convert the low-voltage direct current (dc) output of many individual PV modules into high-voltage

alternating current (ac) power that is fed into the grid. Many off-grid systems also employ charge controllers and batteries to store energy during the day and provide on-demand power during the night. Since current BOS costs typically vary with application but not with PV technology, we refer the reader to the literature on hardware² and non-hardware “soft” BOS costs.³

Solar photovoltaics are the most widely deployed solar electric technology in the world today.

A typical silicon (Si) PV module consists of a glass sheet for mechanical support and protection, laminated encapsulation layers of ethylene vinyl acetate (EVA) for ultraviolet (UV) and moisture protection; 60 to 96 individual 6-inch-square (15-cm-square) solar cells, each capable of producing 4–5 watts under peak illumination (W_p); a fluoropolymer backsheets for further environmental protection; and an aluminum frame for mounting. Common module dimensions are 1 meter by 1.5 meters by 4 centimeters, and peak power ratings range from 260 W to 320 W.

During operation, the front surface of the PV module is illuminated by sunlight. Solar photons are transmitted into each cell, and those photons with sufficiently high energy (i.e., higher than the material-dependent energy bandgap) are absorbed. An absorbed photon transfers its energy to an electron and its positively charged counterpart (a hole). An internal electric field pulls electrons toward one electrode and holes toward the other, resulting in a dc electric current. See Appendix B for a more detailed discussion of the PV conversion process.

ⁱThe analyses in this chapter are discussed in detail in a recent publication by members of the study group.¹

Figure 2.1 Solar PV Energy Conversion

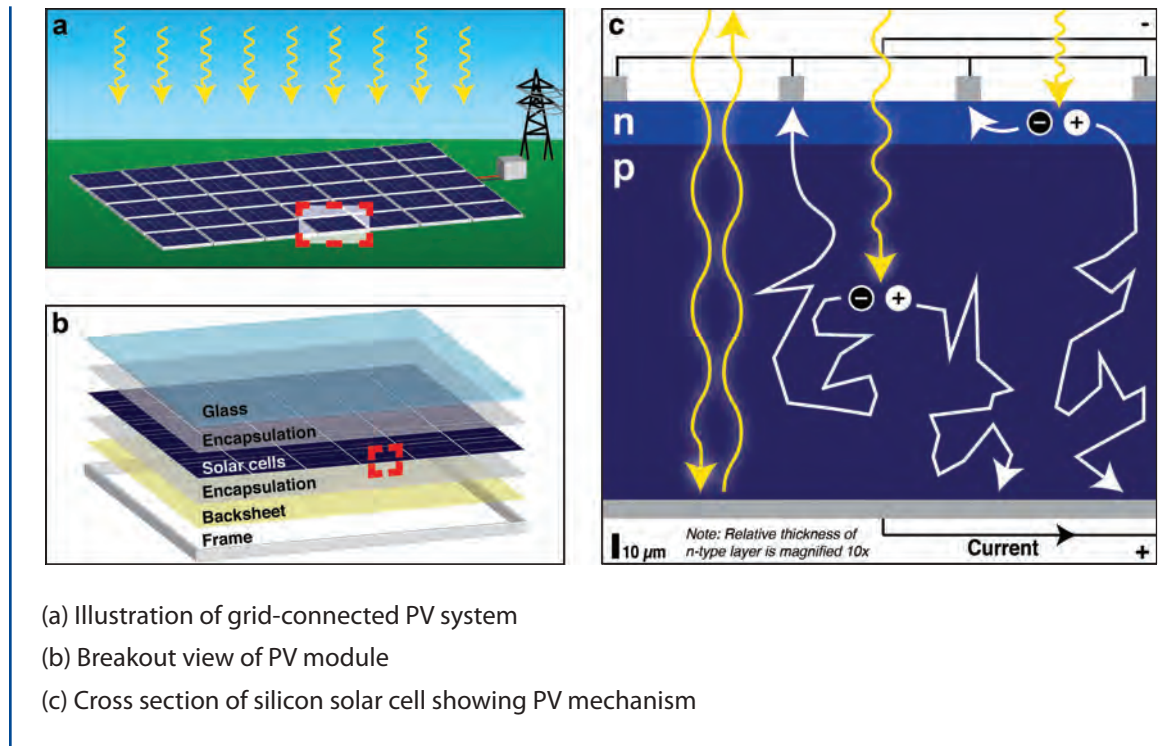

2.2 PV TECHNOLOGY OPTIONS

Solar cell technologies are typically named according to their primary light-absorbing material. As shown in Figure 2.2, PV cells can be classified as either wafer-based or thin film. Wafer-based cells are fabricated on semiconducting wafers and can be handled without an additional substrate, although modules are typically covered with glass for mechanical stability and protection. Thin-film cells consist of layers of semiconducting material deposited onto an insulating substrate, such as glass or flexible plastic. The thin-film PV category can be further divided into commercial and emerging thin-film technologies. A more nuanced PV classification scheme is presented in the next section.

The vast majority of commercial PV module production has been — and remains — silicon-based, for reasons that are both technical and historical. Silicon can be manufactured into non-toxic, efficient, and extremely reliable solar cells, leveraging the cumulative learning of more than 60 years of semiconductor processing for integrated circuits. Crystalline silicon (c-Si) solar cells are divided into two categories: single-crystalline (sc-Si) and multicrystalline (mc-Si). The higher crystal quality in sc-Si cells improves charge extraction and power conversion efficiencies, but requires more expensive wafers (by 20% to 30%⁴). A key disadvantage of

Present crystalline silicon technologies could achieve terawatt-scale deployment by 2050 without major technological advances.

Figure 2.2 Current Solar PV Device Structures

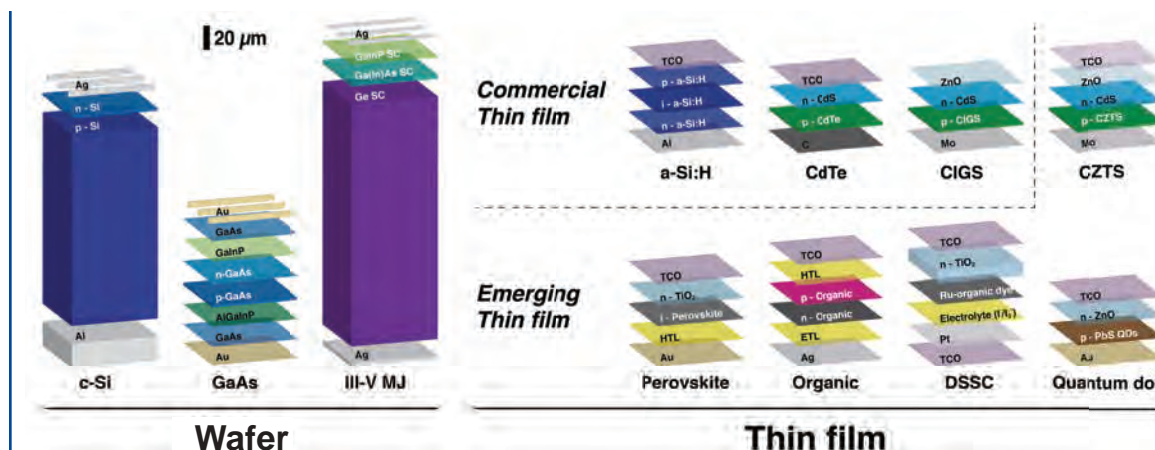

Note: PV device structures are divided into wafer-based and thin-film technologies. Primary light-absorbing layers are labeled in white. Crystalline silicon (c-Si) encompasses single-crystalline and multicrystalline technologies. Modern gallium arsenide (GaAs) cells use thin absorbing films but require wafers as templates for crystal growth. For III-V multijunctions, sub-cells are shown for the industry-standard GaInP/Ga(In)As/Ge triple-junction cell, and some interface layers are omitted for simplicity. A representative single-junction amorphous silicon (a-Si:H) PV structure is shown here, although the a-Si:H PV performance parameters used elsewhere in this chapter correspond to an a-Si:H/nc-Si:H/nc-Si:H triple-junction cell. Front contact grids are omitted for thin-film technologies since the metals used for those grids do not directly contact the active layers and are thus more fungible than those used for wafer-based technologies. Layer thicknesses are shown to scale.

c-Si is its relatively poor ability to absorb light, which encourages the use of thick and brittle wafers. This shortcoming translates to high capital costs, low power-to-weight ratios, and constraints on module flexibility and design. Despite these limitations, c-Si will remain the leading deployed PV technology in the near future, and present c-Si technologies could achieve terawatt-scale deployment by 2050 without major technological advances. Current innovation opportunities include increasing commercial module efficiencies,

reducing manufacturing complexity and costs, reducing the amount of silicon used per watt, and reducing reliance on silver for contact metallization. Materials scarcity limitations for c-Si and other technologies are discussed further in Section 2.5 and in Chapter 6.

FINDING

Crystalline silicon dominates today's PV landscape and will continue to be the leading deployed PV technology for at least the next decade.

Solar cells based on thin films of c-Si can potentially bypass key limitations of conventional wafer-based c-Si PV while retaining silicon's many advantages and leveraging existing manufacturing infrastructure (see discussion in Box 2.1). Like commercial thin-film technologies, thin-film c-Si PV

can tolerate lower material quality (i.e., smaller grains and higher impurity levels). It uses 10–50 times less material than wafer-based c-Si PV, may enable lightweight and flexible modules, and allows high-throughput processing. However, efficiencies for high-throughput-compatible approaches remain low compared to both wafer-based and leading commercial thin-film technologies, and manufacturing scalability is unproven. The only thin-film c-Si technology that has been commercialized to date was based on c-Si films on glass, but no companies remain in that market today.

Solar cells based on thin films of crystalline silicon can potentially bypass key limitations of conventional wafer-based cells while retaining silicon's many advantages and leveraging existing manufacturing infrastructure.

BOX 2.1 WAFER-BASED PV TECHNOLOGIES

Three primary wafer-based technologies exist today:

- Crystalline silicon (c-Si) solar cells constituted approximately 90% of global module production capacity in 2014⁴ and are the most mature of all PV technologies. Silicon solar cells are classified as single-crystalline (sc-Si) or multicrystalline (mc-Si), with respective market shares of approximately 35% and 55% in 2014.⁴ Single crystals are typically grown using the Czochralski (CZ) process; the resulting cylindrical ingots are cut into square wafers to increase packing density, resulting in the distinctive truncated-corner sc-Si cell geometry. A high-efficiency variant is the heterojunction with intrinsic thin layer (HIT) architecture, which combines an *n*-type sc-Si wafer with thin amorphous silicon films. These films passivate surface defects and can increase open-circuit voltages by 5%–10%

compared to sc-Si cells.^{5,6} Multicrystalline wafers are typically formed by block-casting from liquid silicon and consist of randomly oriented crystalline grains with sizes of around 1 cm². Because grain boundaries hinder charge extraction, their presence in mc-Si cells reduces performance relative to sc-Si cells. Record lab-cell efficiencies stand at 25.6% for sc-Si and 20.4% for mc-Si;⁷ record efficiencies for large-area modules are 20.8% for sc-Si and 18.5% for mc-Si.⁸ One fundamental limitation of c-Si is its indirect bandgap, which leads to weak light absorption and requires wafers with thicknesses on the order of 100 microns (μm) in the absence of advanced light-trapping strategies. Key technological challenges include stringent material purity requirements, restricted module form factor, and batch-based cell fabrication and module integration processes with relatively low throughput.

BOX 2.1 WAFER-BASED PV TECHNOLOGIES CONTINUED

- One emerging research direction for c-Si PV is the use of thin (2–50 μm) c-Si membranes instead of wafers as starting material.⁹ Thin films can be produced by thinning of sc-Si wafers,^{10,11} epitaxial growth or direct “epi-free” formation on native c-Si substrates with subsequent release and transfer,^{12,13,14} and direct deposition on foreign substrates with a seed layer.¹² Wafer thinning strategies can produce extremely thin (<2 μm) and flexible free-standing silicon layers¹⁰ and have achieved high efficiencies (21.5% with a 47- μm -thick sc-Si wafer¹¹), but do not reduce material use or facilitate high-throughput processing. Epitaxial and epi-free transfer approaches have been investigated widely; they allow substrate reuse and can produce high-quality c-Si films and devices with a range of thicknesses (22.3% reported¹⁵ and 21.2% certified cell records⁸). However, epitaxial film growth is relatively slow, and cell areas remain limited to that of conventional wafers. Direct seeded growth on foreign substrates (typically by solid phase crystallization) enables high deposition rates and facilitates monolithic integration of durable modules,^{16,17} but the resulting polycrystalline films are generally lower in crystallographic quality, leading to lower efficiencies (11.7% reported¹⁸ and 10.5% certified⁸ with c-Si on glass¹⁶). High-temperature-compatible substrates are also required. Key technical challenges for thin-film c-Si PV include enhancing light absorption by employing advanced anti-reflection and light-trapping strategies, reducing recombination losses by engineering higher-quality crystalline films, reducing processing temperatures to enable flexible substrates and modules without sacrificing material quality, and developing new methods for high-throughput inline module integration.
- Gallium arsenide (GaAs) is a compound semiconductor that is almost perfectly suited for solar energy conversion, with strong absorption, a direct bandgap that is well matched to the solar spectrum, and very low non-radiative energy loss. GaAs has achieved the highest power conversion efficiencies of any material system — 28.8% for lab cells and 24.1% for modules.^{7,8} A technique known as epitaxial liftoff creates thin, flexible GaAs films and amortizes substrate costs by reusing GaAs wafers,¹⁹ but has not yet been demonstrated in high-volume manufacturing. Cost-effective production will require low-cost wafer polishing, which defines a cost floor for epitaxial substrates, as well as improved film quality and more substrate reuse cycles.
- III-V multijunction (MJ) solar cells use a stack of two or more single-junction cells with different bandgaps to absorb light efficiently across the solar spectrum by minimizing thermalization (heat) losses. Semiconducting compounds of group III elements (Al, Ga, In) and group V elements (N, P, As, Sb) can form high-quality crystalline films with variable bandgaps, yielding unparalleled record cell and module efficiencies — 46.0% and 36.7%, respectively, under concentrated illumination.^{7,8} III-V MJs are the leading technology for space applications, with their high radiation resistance, low temperature sensitivity, and high efficiency. But complex manufacturing processes and high material costs make III-V MJ cells prohibitively expensive for large-area terrestrial applications. Concentrating sunlight reduces the required cell area by replacing cells with mirrors or lenses, but it is still unclear whether concentrating PV systems can compete with commercial single-junction technologies on cost. Current research and development (R&D) efforts are focused on dilute nitride materials (e.g., GaInNAs),²⁰ lattice-mismatched (metamorphic) approaches,²¹ and wafer bonding.^{22,23} Key challenges for emerging III-V MJ technologies include improving long-term reliability and large-area uniformity, reducing materials use, and optimizing cell architectures for variable operating conditions.

While c-Si currently dominates the global PV market, alternative technologies may be able to achieve lower costs in the long run. Solar cells based on thin semiconducting films now constitute approximately 10% of global PV module production capacity.⁴ Thin-film cells are made by additive fabrication processes,

While crystalline silicon currently dominates the global PV market, alternative technologies may be able to achieve lower costs in the long run.

which may reduce material usage, manufacturing capital expenditures, and lifecycle greenhouse gas emissions.^{24,25} This category extends from commercial technologies based on conventional inorganic semiconductors (Box 2.3) to emerging technologies based on nanostructured materials (Box 2.4). World-record lab-cell efficiencies for all technologies discussed here are shown in Figure 2.3.

Commercial thin-film PV technologies are represented primarily by cadmium telluride (CdTe), copper indium gallium diselenide (CIGS), and hydrogenated amorphous silicon (a-Si:H). These materials absorb light 10–100 times more efficiently than silicon, allowing the use of films just a few microns (μm) thick, as shown in Figure 2.4. Their low use of raw materials is thus a key advantage of these technologies. Advanced factories can produce thin-film modules in a highly streamlined and automated fashion, leading to low per-watt module costs.

A key disadvantage of today's commercial thin-film modules is their comparatively low average efficiency, typically in the range of 12%–15%, compared to 15%–21% for c-Si. Reduced efficiencies increase system costs due to area-dependent BOS components. Most thin-film materials today are polycrystalline and contain much higher defect densities than c-Si. Some compound semiconductors (e.g., CIGS) have complex stoichiometry, making high-yield, uniform, large-area deposition a formidable process-engineering challenge. Sensitivity to moisture and oxygen often requires more expensive hermetic encapsulation to ensure 25-year reliability. Recycling of regulated, toxic elements (e.g., cadmium) and reliance on rare elements (e.g., tellurium and indium) can limit the potential for large-scale deployment, as discussed in Chapter 6.

Current innovation opportunities in thin-film technology include improving module efficiency, improving reliability by introducing more robust materials and cell architectures, and decreasing reliance on rare elements by developing new materials with similar ease of processing.

FINDING

Inherent limitations of current silicon technologies, including high processing complexity and silicon's inherently poor light absorption, drive the need for sustained R&D in advanced silicon and alternative technologies.

Figure 2.3 Trends in Record Lab-Cell Power Conversion Efficiencies⁷

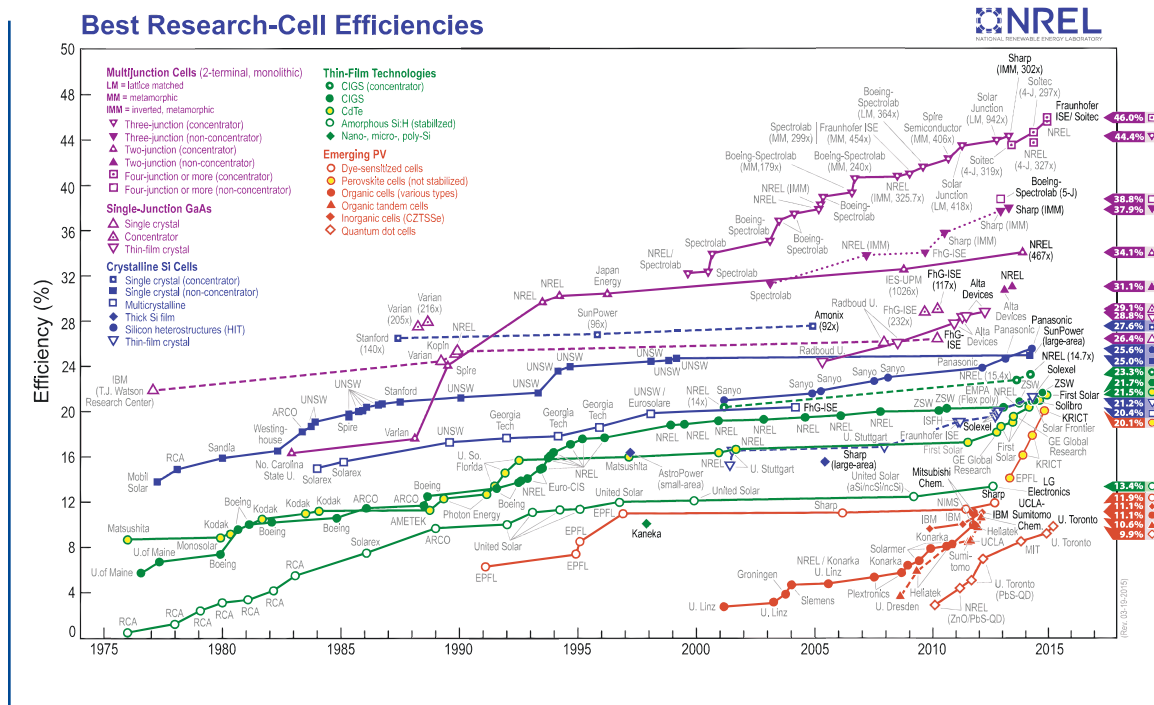

FINDING
Commercial thin-film PV technologies compete well on module cost, but their lower efficiencies may increase overall system cost. Furthermore, the reliance of some thin-film technologies on rare and toxic elements may create materials issues that impede their ability to scale.

In recent years, several new thin-film PV technologies have emerged as a result of intense research and development (R&D) efforts in materials discovery and device engineering. These technologies rely on nanostructured

New thin-film PV technologies offer potentially unique device-level properties that could open the door to novel applications for solar PV.

materials, or nanomaterials, which can be rationally engineered to achieve desired optical and electronic properties. While these technologies range in maturity from fundamental materials R&D to early commercialization and have not yet been deployed at large scale, they offer potentially unique device-level properties such as visible transparency, high weight-specific power (watts per gram [W/g]), and novel form factors. These qualities could open the door to novel applications for solar PV.

Figure 2.4 Solar Cell Thickness by Technology Classification

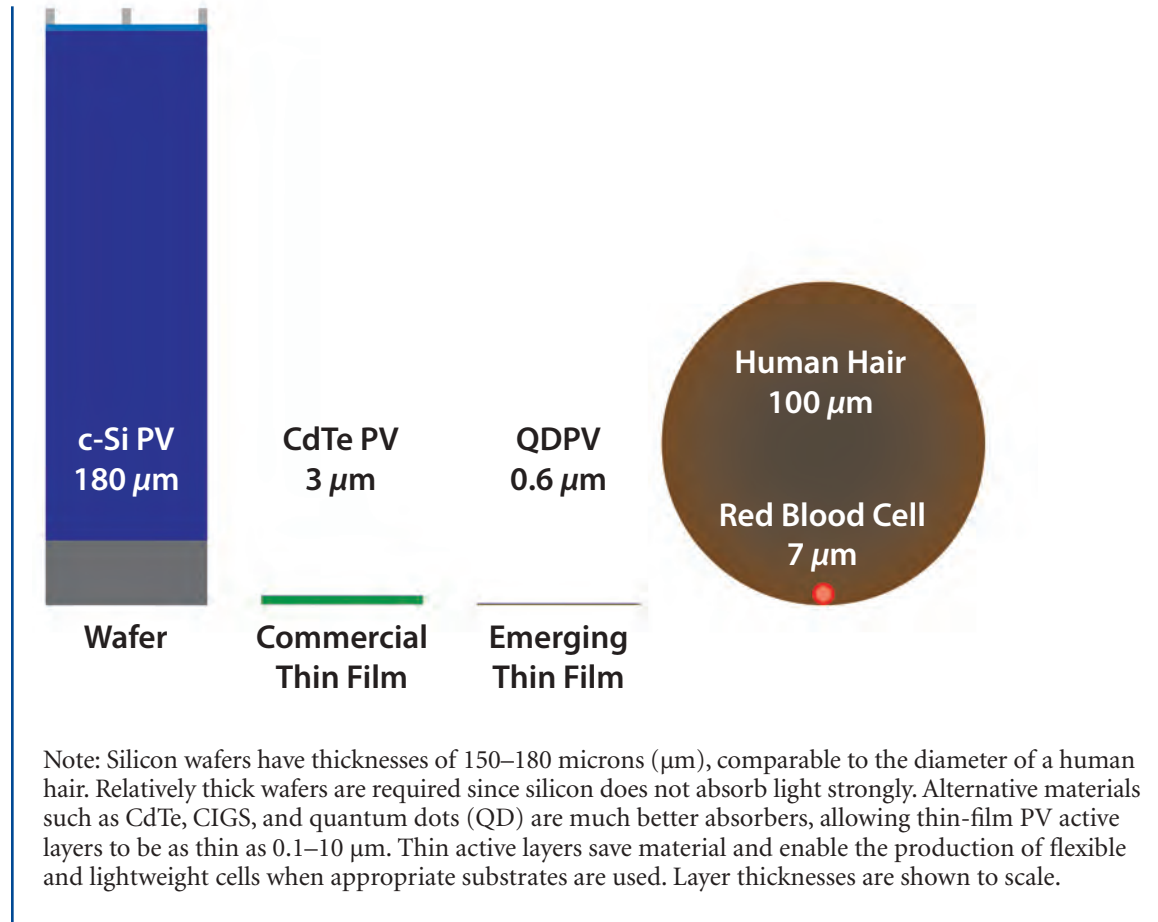

BOX 2.2 COMMERCIAL THIN-FILM PV TECHNOLOGIES

Key commercial thin-film PV technologies include the following:

- Hydrogenated amorphous silicon (a-Si:H) is a non-crystalline form of silicon that offers stronger absorption than crystalline silicon, although its larger bandgap — at 1.5–1.8 electron volts (eV), compared to 1.12 eV for c-Si — reduces the range of wavelengths that can be absorbed. A 300-nanometer (nm) film of a-Si:H can absorb approximately 85% of above-bandgap solar photons in a single pass, enabling the production of lightweight and flexible solar cells. An a-Si:H cell can be combined with cells based on nanocrystalline silicon (nc-Si) or amorphous silicon-germanium (a-SiGe) alloys to form a multijunction (MJ) cell without lattice-matching requirements. Most commercial a-Si:H modules today use MJ cells. Silicon is cheap, abundant, and non-toxic, but while a-Si:H cells are well suited for small-scale and low-power applications, their susceptibility to light-induced degradation (known as the Staebler-Wronski effect²⁶) and their low efficiency compared to other mature thin-film technologies (13.4% triple-junction lab record⁸) limit market adoption.
- Cadmium telluride (CdTe) is the leading thin-film PV technology in terms of worldwide installed capacity. CdTe is a favorable semiconductor for solar energy harvesting, with strong absorption across the solar spectrum and a direct bandgap of 1.45 eV. Record efficiencies of 21.0% for lab cells and 17.5%

for modules are among the highest for thin-film solar cells, and commercial module efficiencies continue to improve steadily.^{7,8} CdTe technologies employ high-throughput manufacturing processes and offer the lowest module costs of any PV technology on the market today, although relatively high processing temperatures are required (~500°C). Concerns about the toxicity of elemental cadmium (Cd)²⁷ and the scarcity of tellurium (Te) (see Chapter 6) have motivated research on alternative material systems that exhibit similar ease of manufacturing but rely on abundant and non-toxic elements.

- Copper indium gallium diselenide ($\text{CuIn}_x\text{Ga}_{1-x}\text{Se}_2$, or CIGS) is a compound semiconductor with a direct bandgap of 1.1–1.2 eV. Like CdTe, CIGS films can be deposited by a variety of solution- and vapor-based techniques on flexible metal or polyimide substrates, favorable for building-integrated and other unconventional PV applications. CIGS solar cells exhibit high radiation resistance, a necessary property for space applications. Record efficiencies stand at 21.7% for lab cells and 15.7% for modules.^{7,8} Key technological challenges include high variability in film stoichiometry and properties, limited understanding of the role of grain boundaries, low open-circuit voltage due to material defects, and the engineering of higher-bandgap alloys to enable MJ devices. Scarcity of elemental indium (In) (see Chapter 6) could hinder large-scale deployment of CIGS technologies.

BOX 2.3 EMERGING THIN-FILM PV TECHNOLOGIES

Key emerging thin-film PV technologies include the following:

- Copper zinc tin sulfide ($\text{Cu}_2\text{ZnSnS}_4$, or CZTS) is an Earth-abundant alternative to CIGS, with similar processing strategies and challenges. One key challenge involves managing a class of defects known as cation disorder — uncontrolled inter-substitution of copper (Cu) and zinc (Zn) cations creates point defects that can hinder charge extraction and reduce the open-circuit voltage. Certified record lab-cell efficiencies have reached 12.6%.^{8,28}
- Perovskite solar cells recently evolved from solid-state dye-sensitized cells,^{29,30} and have quickly become one of the most promising emerging thin-film PV technologies, with leading efficiencies advancing from 10.9% to 20.1% in less than three years of development.^{7,31,32} The term “perovskite” refers to the crystal structure of the light-absorbing film, and the most widely investigated perovskite material is the hybrid organic-inorganic lead halide $\text{CH}_3\text{NH}_3\text{PbI}_{3-x}\text{Cl}_x$. Polycrystalline films can be formed at low temperatures by solution or vapor deposition.^{31,33} Key advantages of this class of material include long charge carrier diffusion lengths, low recombination losses, low materials cost, and the potential for bandgap tuning by cation or anion substitution. Early perovskite devices have achieved impressively high open-circuit voltages (about 1.1 V), typically the most difficult solar cell performance parameter to improve. Key technological challenges include the refined control of film morphology and material properties, high sensitivity to moisture, unproven cell stability, and the use of toxic lead.
- Organic photovoltaics (OPV) use organic small molecules or polymers to absorb incident light. These materials consist mostly of Earth-abundant elements and can be assembled into thin films by low-cost deposition methods, such as inkjet printing and thermal evaporation. Organic multijunction (MJ) cells may be much easier to fabricate than conventional MJ cells because of their high defect tolerance and ease of deposition. Small-molecule and polymer OPV technologies have recently reached 11.1% efficiencies in the lab,⁷ but large-area cell and module efficiencies remain much lower. Key concerns involve inefficient transport of excited electron-hole pairs and charge carriers, low large-area deposition yield, poor long-term stability under illumination, and comparatively low ultimate efficiency limits.
- Dye-sensitized solar cell (DSSC) technology is among the most mature and well understood of nanomaterial-based PV options. These photoelectrochemical cells consist of a transparent inorganic scaffold (typically a nanoporous titanium dioxide film) sensitized with light-absorbing organic dye molecules (usually ruthenium complexes). Unlike the other technologies discussed here, which rely on solid-state semiconductors to transport electrons and generate a photocurrent, DSSCs often use a liquid electrolyte to transport ions to a platinum counter electrode. DSSCs have achieved efficiencies of up to 12.3%³⁴ (11.9% certified⁷) and may benefit from low-cost materials, simple assembly, and the possibility of flexible modules. Key challenges involve limited long-term stability under illumination and high temperatures, low absorption in the near-infrared, and low open-circuit voltages caused by interfacial recombination.
- Colloidal quantum dot photovoltaics (QDPV) use solution-processed nanocrystals, also known as quantum dots (QD), to absorb light. The ability to tune the absorption spectrum of colloidal metal chalcogenide nanocrystals, primarily lead sulfide (PbS), allows efficient harvesting of near-infrared photons, as well as the potential for MJ cells using a single material system. QDPV technologies are improving consistently, with a record lab-cell efficiency of 9.2%,⁷ and they offer promising ease of fabrication and air-stable operation. Key challenges include incomplete understanding of QD surface chemistry, low charge carrier mobility, and low open-circuit voltages that may be limited fundamentally by mid-gap states or inherent disorder in QD films.

2.3 PV TECHNOLOGY CLASSIFICATION BY MATERIAL COMPLEXITY

Solar PV technologies can be ranked by power conversion efficiency, module cost, material abundance, or any other performance metric. The next section discusses several important application-specific metrics. The most widely used classification scheme today relies on two metrics, module efficiency and area cost, that delineate three distinct generations.^{35,36}

1. First generation (G1) technologies consist of wafer-based cells of c-Si and GaAs.
2. Second generation (G2) technologies consist of thin-film cells, including a-Si:H, CdTe, and CIGS.

3. Third generation (G3) technologies include novel thin-film devices, such as dye-sensitized, organic, and quantum dot (QD) solar cells, along with a variety of “exotic” concepts and strategies, including spectral-splitting devices (e.g., MJ cells), hot-carrier collection, carrier multiplication, and thermophotovoltaics.³⁵

This generational scheme may not adequately describe the modern PV technology landscape. Many new technologies like QD and perovskite solar cells resist classification, yet have largely been lumped together under the G3 label of “advanced thin films.”³⁶ Any chronological classification scheme is likely to treat older technologies pejoratively, in favor of new “next-generation” concepts. Yet silicon and commercial thin-film technologies, such as CdTe, far outperform emerging thin-film technologies.

Figure 2.5 Limited Utility of Generational Classification Scheme

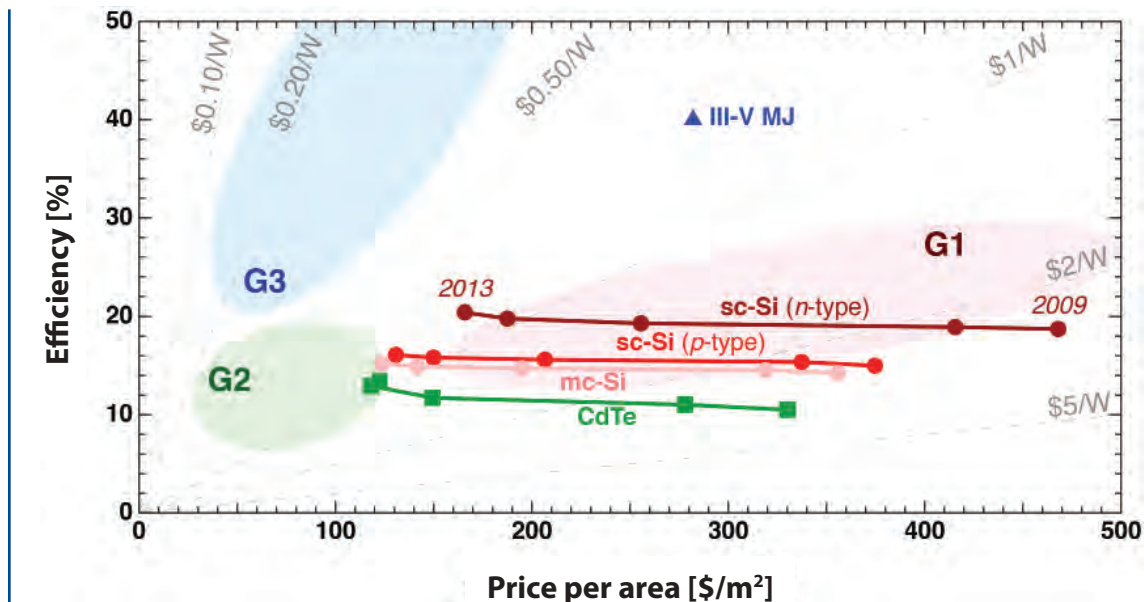

Note: The figure plots trends in module efficiency³⁷ and price per area (derived from pvXchange module price indices³⁸) over the period from 2009 to 2013. Trends are shown for commercial PV technologies in three conventional generations (G1 in red, G2 in green, and G3 in blue). Current G1 and G2 modules cluster near the region originally defined as G2, limiting the usefulness of this representation. The single G3 data point corresponds to performance projections for a III-V MJ module.²³

The three generations are commonly represented as shaded regions on a plot of module efficiency vs. area cost. Figure 2.5 shows these regions as originally defined in 2001,^{35,iii} along with module performance trends for commercial PV technologies from 2009 to 2013. All technologies move toward the upper-left corner with time as efficiencies rise and costs fall. Although historical G1 and G2 price and performance data fall roughly in the stated zones, current modules do not obey this delineation. Nearly all current G1 (c-Si) and G2 (CdTe) technologies appear close to the zone designated G2. Furthermore, no G3 technology to our knowledge has reached the zone marked G3. More generally, we find that average commercial module prices for both G1 and G2 technologies tend to cluster along a single $\$/W_p$ line in any given year, likely due to competitive market dynamics.

The repeating units that constitute the active material in modern PV technologies run the gamut in complexity from single silicon atoms to quantum dots that contain thousands of lead and sulfur atoms.

This report advocates an alternative approach to PV technology classification that is based on material complexity. Material complexity can be defined roughly as the number of atoms in a unit cell, molecule, or other repeating unit.ⁱⁱⁱ The repeating units that constitute the active material in modern PV technologies run the gamut in complexity from single silicon atoms

to quantum dots that contain thousands of lead and sulfur atoms.

In this framework, all PV technologies fall on a spectrum from elemental (lowest) to nano-material (highest) complexity, as shown in Figure 2.6. At one end of the material complexity spectrum are wafer-based technologies with relatively simple building blocks, including c-Si and III-V cells. Technologies based on more complex materials fall under the broad umbrella of thin-film solar cells, ranging from polycrystalline thin films, such as CdTe and CIGS, to complex nanomaterials such as organics and QDs.

Material complexity is not equivalent to processing complexity. In fact, one type of complexity can often be traded off for the other: Silicon may be considered a simple material, but processing silicon is a complex industrial procedure, due to relatively stringent purity requirements for solar-grade material.^{iv} More complex materials typically employ solution-based synthetic procedures. Once synthesized, they can be deposited as thin films quickly and easily, without expensive equipment or high-temperature processing.

It is also important to note that higher material complexity is not always better. Technological maturity and cell efficiencies tend to vary inversely with complexity. In the history of semiconductor technology, crystalline materials based on elemental and compound building

ⁱⁱThe generations shown in Figure 2.5 are typically represented in terms of cost per area, rather than price per area. Here we use module prices because manufacturing cost data are not consistently available. However, we must emphasize that price is an imperfect proxy for underlying costs. Thus, reductions in module price may not reflect technological progress.

ⁱⁱⁱMaterial complexity is associated with the degree of disorder in a material. Amorphous materials can be qualitatively classified as generally more complex than their crystalline counterparts, since relative atomic positions are well defined in crystals, less defined in polycrystalline films, and not at all defined in amorphous films.

^{iv}Solar-grade silicon (SG-Si) is typically refined to a purity of “six nines” (99.9999%). Integrated circuit (IC) manufacturing requires a silicon purity of “nine nines” (99.9999999%). For comparison, materials used in organic solar cells and other emerging thin-film technologies often have purities on the order of 99%. Less-stringent purity requirements often reduce processing complexity and cost.

blocks were discovered, studied, and engineered first, for electronic and optoelectronic devices alike. The first solar cell, made in 1883 by Charles Fritts, was based on a wafer of selenium. Less complex materials like silicon are better understood than novel nanomaterials; improved control over electronic and optical

properties allows better device modeling and engineering. C-Si and conventional III-V semiconductors have achieved the highest efficiencies among PV technologies, and silicon now commands by far the largest share of the global market.

Figure 2.6 Alternative PV Technology Classification Scheme Based on Material Complexity

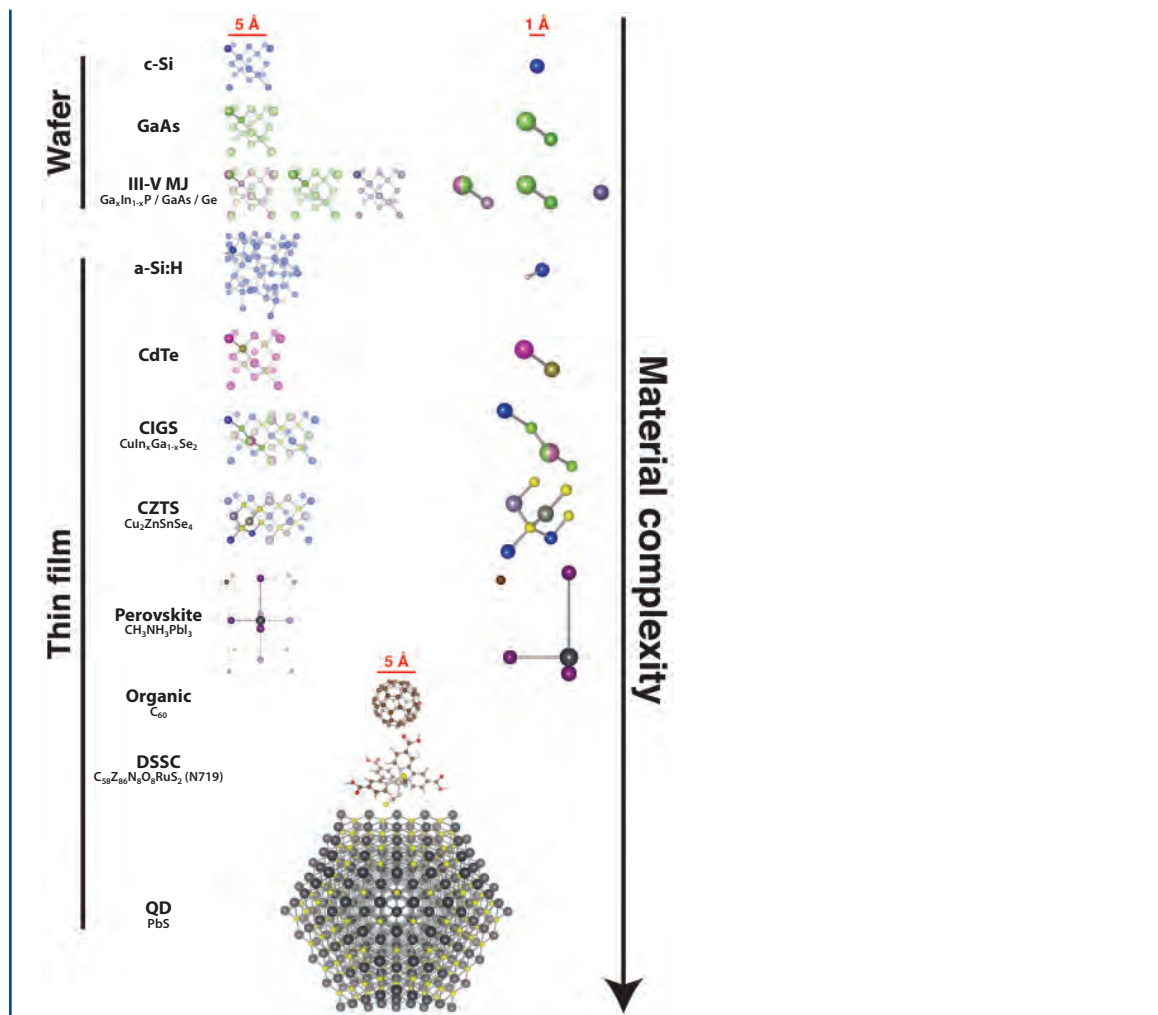

Note: Crystal unit cells or molecular structures of representative materials are shown for each technology, with crystal bases highlighted and expanded (right column) to illustrate the relative complexity of different material systems. Lattice constants and bond lengths are shown to scale, while atomic radii are 40% of actual values. Scale bars are in angstroms (1 Å = 0.1 nm = 10⁻¹⁰ meter). Wafer-based materials consist of single- or few-atom building blocks. Thin-film materials range from amorphous elemental materials (a-Si:H) to complex nanomaterials with building blocks containing up to thousands of atoms (e.g., PbS QDs). Single carbon atoms (brown) in the perovskite crystal structure represent methylammonium (CH₃NH₃) cations.

Increased material complexity gives rise to several novel and potentially valuable technological attributes.

On the other hand, increased material complexity also gives rise to several novel and potentially valuable technological attributes:

Reduced materials use – Absorber thicknesses tend to decrease with increasing complexity, since complex building blocks are often engineered or selected for maximum light absorption. Strong absorption in nanomaterials reduces material use and cell weight.

Flexible substrates and versatile form factors – Commercial thin-film PV technologies are characterized by one-step formation of the absorber material on a substrate, while emerging thin films often employ separate active material synthesis and deposition steps. Synthesizing building blocks such as organic molecules and QDs in a separate chemical reaction at high temperatures allows them to be deposited at low temperatures. Flexible and lightweight plastic substrates can then be used, potentially enabling high weight-specific power.

Visible transparency – The lack of long-range crystalline order in organic molecules leads to light absorption that does not strictly increase with photon energy. Non-monotonic absorption allows some organic materials to absorb infrared radiation while transmitting visible light, potentially enabling the development of visibly transparent solar cells.

Defect tolerance – Complex nanomaterials may tolerate defects and impurities more readily than single-crystalline and polycrystalline materials.

Since future solar cell applications may well require some or all of these performance characteristics, improving the conversion efficiency and stability of promising complex material platforms is a key priority for technology innovation.

2.4 PERFORMANCE METRICS FOR FUTURE PV APPLICATIONS

To understand the technical challenges for PV adoption and scale-up, it is instructive to define performance metrics that can be used to compare candidate PV technologies. These metrics can be purely technical or may incorporate both technical and economic factors. This section considers key performance metrics that will drive PV adoption in two primary classes of applications: grid connected and off grid.

Grid-connected applications, including those at the residential, commercial, and utility scale, involve ground- or roof-mounted PV arrays with peak power outputs ranging from a few kilowatts to hundreds of megawatts. Grid connectivity imposes a single dominant

Grid connectivity imposes a single dominant requirement: low levelized cost of electricity.

requirement: low levelized cost of electricity (LCOE, in \$/kWh). A comparison of LCOE for solar PV and for competing generation sources dictates the economic feasibility of a grid-connected PV system, although it is worth emphasizing that LCOE alone may underestimate the value of solar generation due to temporal variation in electricity demand and price (see Chapter 5 and Schmalensee³⁹). Other important metrics include system cost (\$/W_p), energy yield (kWh/W_p), reliability, and — where roof loading is crucial — specific power. Most of these metrics also directly affect LCOE.

Off-grid applications for PV technology, including applications to power portable devices and for deployment in developing countries, tend to value system cost along with a variety of non-cost factors, such as specific power, form factor (e.g., flexibility), aesthetics, and durability. One leading example is the use of small-area solar cells to power mobile phones and other portable electronic devices. In many applications, significant value may derive from low module weight, making specific power an important metric. It should be noted that PV technologies with efficiencies too low to power the developed world's high-power mobile devices are often adequate for the developing world's low-power mobile needs.

PV technologies with efficiencies too low to power the developed world's high-power mobile devices are often adequate for the developing world's low-power mobile needs.

Another potential off-grid application is building-integrated PV (BIPV), in which PV modules are used in structural features that are not primarily associated with electricity production (e.g., windows, skylights, shingles, tiles, curtains, and canopies). Aesthetic concerns often drive module form factor and positioning, which may be sub-optimal for solar energy collection. That said, some BIPV systems may achieve competitive LCOE by piggybacking on the materials, installation, and maintenance costs of the existing building envelope. Other areas for potential PV applications are discussed in Box 2.4.

BOX 2.4 UNIQUE PV APPLICATIONS

The technical demands of diverse applications continue to drive major foundational R&D efforts toward the development of alternative PV technologies. So-called "next-gen" technologies can be classified according to their purpose:

- Ultra-high efficiency – Some applications (e.g., satellites and defense applications) require power conversion efficiencies over 30%, twice the efficiency of typical commercial modules. Achieving such high efficiencies often requires more expensive approaches involving multiple absorber materials (e.g., multijunction (MJ) and spectral-splitting devices) or concentration of sunlight. Most recently, considerable effort has been dedicated to combining c-Si technology with an overlayer of wide-bandgap thin-film material, such as III-Vs, chalcogenides, metal oxides, or perovskites.

- Unique form factors – Some applications may benefit from form factors that depart from traditional glass-covered modules. Examples include BIPV, portable consumer devices, and solar textiles. Flexible solar cells and novel three-dimensional architectures may facilitate the ubiquitous deployment of PV technologies.
- Unique aesthetics – Colored or transparent solar cells, which absorb infrared or ultraviolet light, may be considered to have aesthetic advantages when incorporated into certain applications, including construction façades, windows, and consumer electronics.

2.5 PV TECHNOLOGY TRENDS

The performance metrics described above reflect application-specific performance demands. The extent to which these needs are fulfilled by any particular PV technology will determine the commercial viability of that technology. These metrics translate to three technologically relevant characteristics that will be shared by most future PV technologies and that can help guide future technology development. We expect technologies exhibiting these characteristics to be deployed in a wide variety of applications.

No single PV technology today excels in all three key technical characteristics: high power conversion efficiency, low materials usage, and low manufacturing complexity and cost.

1. High power conversion efficiency

(% or W/m^2) – We expect to see continuous but incremental progress toward higher efficiencies as technologies improve. Increasing sunlight-to-electricity conversion efficiency directly benefits most of the metrics discussed earlier. However, gains in efficiency at the module level often result from sustained investment in R&D, capital equipment, and increasingly complex manufacturing processes. Thus it is reasonable to anticipate a gradual trend toward higher efficiencies over many years, rather than a sudden quantum leap in performance.

2. Low materials usage (g/m^2 or g/W) –

We expect a trend toward lower materials usage for all technologies. Thinner glass, frames, and active layers can reduce material consumption and cost, and increase specific power and cell flexibility. In addition, PV technologies that require scarce elements may be unable to achieve terawatt-scale deployment (see Chapter 6). Materials use and elemental abundance for different technologies are shown in Figure 2.7.

3. Low manufacturing complexity and cost –

High capital equipment expenditures for manufacturing plants may be a bottleneck for large-scale PV deployment. In any case, there is a premium on low upfront equipment cost. For both c-Si and alternative technologies, streamlined manufacturing approaches could simultaneously reduce upfront cost and enable new form factors. Both should therefore be prioritized in R&D efforts. Examples include flexible solar cells printed by low-cost methods using CIGS, QD, or organic inks, though we note that the latter two types have not yet been demonstrated at scale. Key technical challenges for such approaches typically involve module reliability, manufacturing yield, and efficiency.

No single PV technology today excels in all three technical characteristics listed above. Figure 2.8 compares the technological maturity, power conversion efficiency, materials use, and specific power of today's PV technologies. Such comparisons point to several general observations: (1) C-Si and conventional thin films are the only technologies deployed at large scale today. (2) Record efficiencies for large-area modules lag behind those of lab cells by a significant margin, as discussed in Box 2.5. (3) Thin-film PV technologies use 10 to 1000 times less material than c-Si, reducing cell weight per unit area and increasing power output per unit weight. (4) All PV technologies deployed today have been under development for at least three decades.

Figure 2.7 Materials Usage, Abundance, and Cost for Key Elements Used in Commercial and Emerging PV Technologies

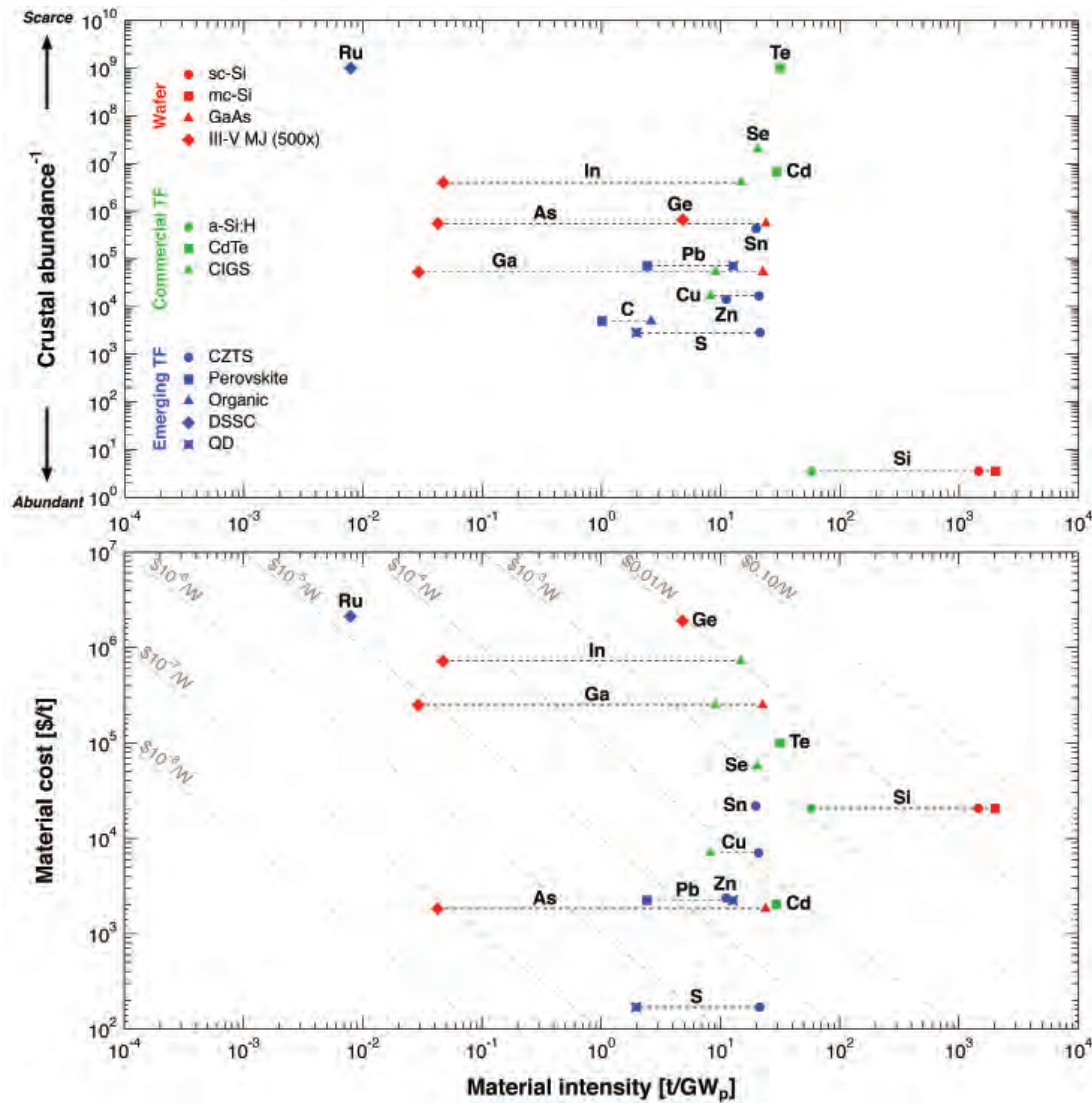

Note: Material intensities are calculated using typical device structures and absorber compositions, assuming 100% material utilization and manufacturing yield, and current record lab-cell efficiencies.⁷ Each element has an estimated crustal abundance⁴⁰ and market price and thus a fixed position along the y-axis, but varies in position along the x-axis depending on technology-specific material needs. Technologies that tend toward the lower left corner of each plot can achieve large-scale deployment with lower risk of raw material cost and availability limitations. In the bottom plot, gray dashed lines indicate the contribution of raw material costs to the total cell cost in $\$/W_p$, assuming current market prices. Material intensities are calculated for III-V MJs based on the standard triple-junction cell described earlier, for a-Si:H based on an a-Si:H/nc Si:H/nc Si:H triple-junction, for organic cells based on a tandem polymer device structure, for perovskite cells based on the mixed-halide perovskite $CH_3NH_3PbI_2Cl$, and for DSSCs based on the common N719 dye. A concentration ratio of 500x is assumed for III-V MJs.

Figure 2.8 Key Metrics for Photovoltaic Technologies Ordered by Material Complexity

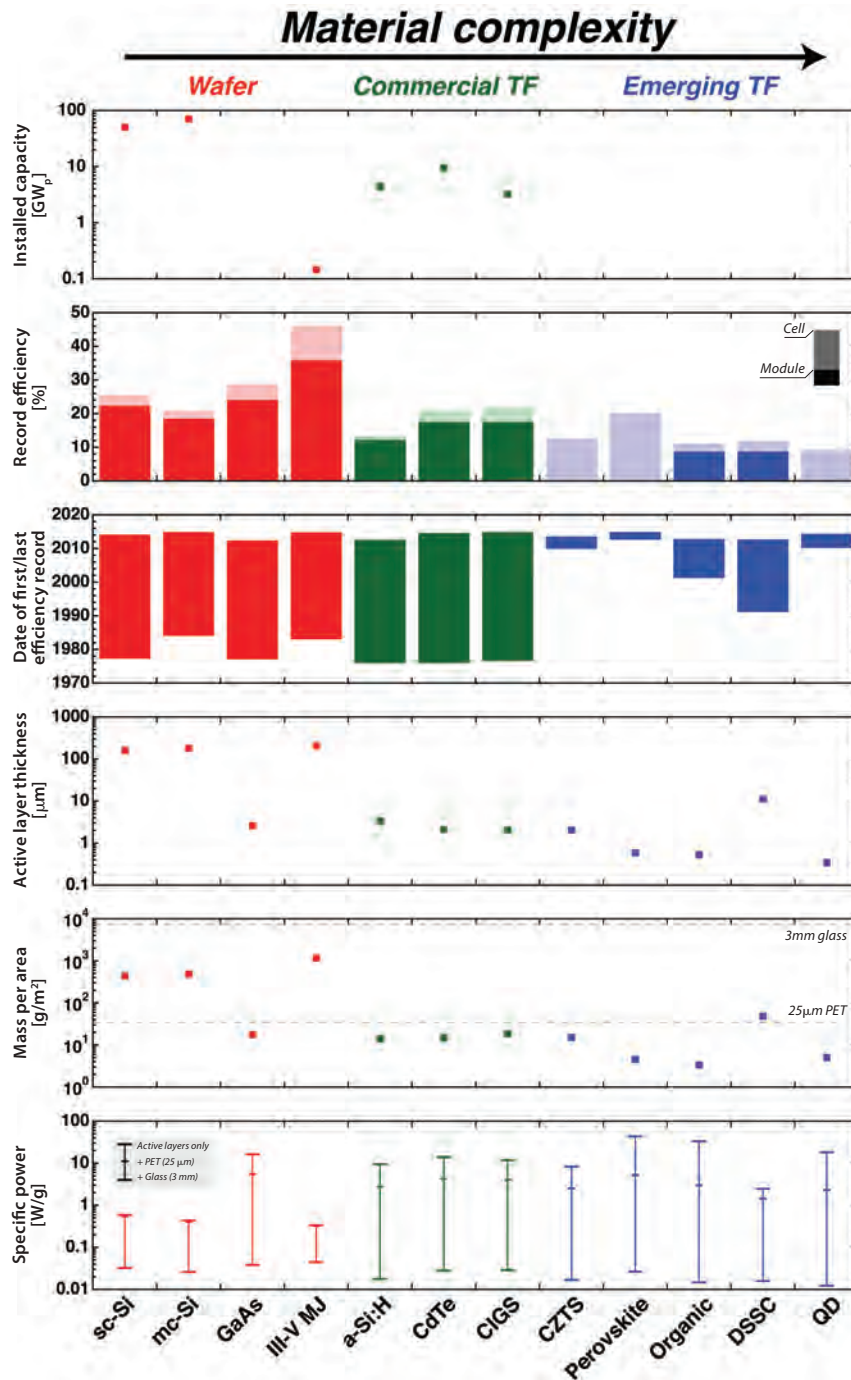

Note: Metrics are current at the time of this writing and include cumulative global installed capacity,^{41,42} power conversion efficiency under 1 sun (except III-V MJ), time elapsed since first certified by the National Renewable Energy Laboratory (NREL),⁷ absorber thickness, and cell mass per area. All of these metrics generally decrease with increasing material complexity. Specific power is shown for active layers alone and for cells with a substrate or encapsulation layer made of 25- μm polyethylene terephthalate (PET) or 3-mm glass. Despite their lower efficiencies, thin-film cells on thin and flexible substrates can achieve much higher specific power than wafer-based cells. All metrics are calculated based on record efficiency or representative device structures. Record lab-cell efficiencies are assumed in specific power calculations. A concentration ratio of 500x is assumed for III-V MJs unless otherwise specified.

Today's emerging technologies are improving far faster than current deployed technologies improved in their early stages, but it is important to note that the road to market and large-scale deployment is invariably long.

It is clear that innovation opportunities exist for all PV technologies.

Practical limits to PV deployment will depend on a wide range of technological and economic factors, as discussed in Chapter 6. While the goal need not be a “silver-bullet” technology — different applications may call for different solutions — it is clear that innovation opportunities exist for all PV technologies.

BOX 2.5 MODULE VS. CELL EFFICIENCY

Commercial PV modules can be up to 40% less efficient than small-area lab cells. Two primary types of losses — intrinsic and extrinsic — occur in the transition from research lab to production line.

- Intrinsic scaling losses: Scaling from small cells to large modules with multiple interconnected cells incurs physical scaling losses.
 - Increase in cell size (approximately 1 cm² to 100 cm²): For technologies employing electrode grids (rather than transparent conducting electrodes alone), electrons must travel farther to reach an electrode in larger cells, resulting in higher resistive losses. Shadowing from electrodes reduces available light, while higher non-uniformity over large areas increases the likelihood of reverse current leakage (shunts).
 - Increase in number of cells: Longer wires dissipate more power through resistive heating. Spacing between cells reduces the active area of the module. The output current of series-connected cells is limited by the lowest-performing cell.
- Extrinsic manufacturing losses: While researchers often target the highest possible efficiencies without regard to cost, manufacturers may sacrifice efficiency to reduce cost, improve yield, and increase throughput.
 - Process: Fabrication techniques that produce high efficiencies in the lab may be ineffective or too costly for large-scale manufacturing. Increasing production scale also increases contamination risk.⁴³
 - Materials: Research labs work primarily with small-area devices and can afford to use scarce, expensive, or high-purity materials, such as gold electrodes and high-quality glass substrates. Higher-quality materials may have fewer defects, lower recombination losses, and lower undesired absorption (e.g., in encapsulation and electrode materials).

Materials discovery has historically been a critical component of PV technology development. New active materials may reach cost and performance targets that are inaccessible using existing materials. Reliance on Earth-abundant materials bodes well for large-scale deployment, and ultra-thin, room-temperature-processed absorbers may simultaneously reduce manufacturing costs and enable flexible form factors and novel applications. Recognizing that

New active materials may reach cost and performance targets that are inaccessible using existing materials.

current large-scale commercialization of c-Si, CdTe, and CIGS has been driven largely by historical chance discoveries and subsequent industry momentum, a full-scale computational and experimental search is currently underway for other promising materials. Three PV technologies — copper zinc tin sulfide (CZTS), perovskites, and organics — have reached efficiencies greater than 10% within the last five years alone, suggesting that the potential for disruptive innovation remains.

FINDING

Emerging thin-film technologies are promising for large-scale deployment and offer unique functionality for future PV applications.

To transition from laboratory to pilot production line, any new PV technology must demonstrate a substantial potential advantage over current alternatives in terms of one or more performance metrics, without major disadvantages. Key considerations for measuring PV module and system performance are discussed in Box 2.6. If anticipated improvements are merely marginal, any cost or performance gains may not be evident until gigawatt-scale manufacturing is realized. At current \$1/W_p investment costs for c-Si, a factory capable of manufacturing 1 gigawatt of PV capacity per year requires a billion-dollar capital investment. This high barrier to entry has thus far inhibited the rapid commercialization of many emerging technologies with insufficient perceived advantages, but it also increases the value of technologies with lower capital equipment requirements, as discussed above. Recent over-investment in c-Si raises the bar further for new and unproven alternatives.

BOX 2.6 MEASURING PV MODULE AND SYSTEM PERFORMANCE

The dc peak power rating of a PV module or system (in W_p) reflects its efficiency under standard test conditions (STC): 1000 W/m² irradiance, 25°C operating temperature, and air mass 1.5 (AM1.5) spectrum. But the actual ac energy output depends strongly on actual insolation, shading losses (e.g., soiling and snow coverage), module efficiency losses (e.g., at elevated temperatures or low insolation), and system losses (e.g., module mismatch, wire resistance, inverter and transformer losses, tracking inaccuracy, and age-related degradation). The energy yield (in kWh/ W_p) is a module-level performance metric that quantifies the lifetime ac energy output per unit of installed capacity. To reduce levelized cost of electricity (LCOE), efforts to advance module and balance of system (BOS) technology will focus on increasing energy yield, making heat and light management, durability, and reliability more important. An inherent tension exists between improving these technical factors and reducing the area cost (\$/m²) of the module. Energy yield is proportional to the capacity factor, as defined below.

The performance of a deployed PV system is typically characterized by its actual ac energy output per year, relative to the expected dc output. The expected output can be calculated in terms of either ideal or actual insolation, yielding two different metrics: The capacity factor (CF) compares system output to the performance of an ideal (lossless) system with identical nameplate capacity under constant peak (1000 W/m²) irradiance. The performance ratio (PR) or quality factor (Q) instead compares system output to that of an ideal system in the same location.

$$CF = \frac{\text{Actual ac output [kWh/y]}}{\text{dc peak power rating [kW}_p\text{]} \times 8,760 \text{ [h/y]}}$$

$$PR = \frac{\text{Actual ac output [kWh/y]}}{\text{dc peak power rating [kW}_p\text{]} \times 8,760 \text{ [h/y]} \times \text{Average plane-of-array irradiance [W/m}^2\text{]}/1,000 \text{ [W/m}^2\text{]}}$$

Capacity factors are commonly used to compare power generation systems. The annual capacity factor for a typical utility-scale solar PV system is around 20%, compared to 22% for solar thermal, 31% for wind, 40% for hydropower, 44% for natural gas combined cycle, 64% for coal, and 90% for nuclear plants.⁴⁴ Solar power systems without storage can operate only when sunlight is available; this constraint alone limits the capacity factor to the fraction of daylight hours. By accounting for geographical and temporal variations in insolation (discussed in Appendix A), the performance ratio isolates system losses and allows for a comparison of PV systems in different locations.

The solar cell of the future may be a refined version of current commercial cells or an entirely new technology.

2.6 CONCLUSION

Predicting the future development of any technology is inherently fraught with uncertainty. While silicon technology dominates the PV market today, alternative technologies are evolving rapidly. The solar cell of the future may be a refined version of current commercial cells or an entirely new technology. Furthermore, global installed PV capacity today is a minuscule fraction of expected future deployment. Few — if any — industries have grown as fast or as unpredictably as the PV industry in recent years.

Faced with uncertain technological change and uncertain economic pressures, we abstain from betting on any particular PV technology. Instead, we view all technologies through the objective lens of application-driven performance metrics. These metrics point to three technical trends — increased efficiency, reduced materials usage, and reduced manufacturing complexity and cost — that technology leaders should target in their R&D efforts. Focusing on the unique strengths and potential applications of solar PV will help to identify windows of opportunity for future PV technology development and deployment.

REFERENCES

- ¹Jean, J., P.R. Brown, R.L. Jaffe, T. Buonassisi, and V. Bulovic. "Pathways for Solar Photovoltaics." *Energy & Environmental Science* 8, no. 4 (2015): 1200–1219. <http://dx.doi.org/10.1039/C4EE04073B>
- ²Bony, L. S. Doig, C. Hart, et al. *Achieving Low-Cost Solar PV: Industry Workshop Recommendations for Near-Term Balance of System Cost Reductions*, Rocky Mountain Institute. (September 2010). <http://www.rmi.org/Content/Files/BOSReport.pdf>
- ³Friedman, B. K. Ardani, D. Feldman, et al. *Benchmarking Non-Hardware Balance-of-System (Soft) Costs for U.S. Photovoltaic Systems, Using a Bottom-Up Approach and Installer Survey – Second Edition*. National Renewable Energy Laboratory Technical Report. NREL/TP-6A20-604 12 (October 2013). <http://www.nrel.gov/docs/fy14osti/60412.pdf>
- ⁴Metz, A, M. Fischer, G. Xing, et al. *International Technology Roadmap for Photovoltaic (ITRPV): 2013 Results*. Revision 1. (March 24, 2014). http://itrvp.net/cm4all/iproc.php/Reports%20downloads/ITRPV_2014_Roadmap_Revision1_140324.pdf?cdp=a
- ⁵Kinoshita, T., D. Fujishima, A. Yano, et al. "The Approaches for High Efficiency HITM Solar Cell with Very Thin (<100 μm) Silicon Wafer Over 23%." *26th European Photovoltaic Solar Energy Conference and Exhibition*. (2011): 871–874. <http://www.eupvsec-proceedings.com/proceedings?paper=9942>
- ⁶Tsunomura, Y., Y. Yoshimine, M. Taguchi, et al. "Twenty-two Percent Efficiency HIT Solar Cell." *Solar Energy Materials and Solar Cells* 93, no. 6 (2009): 670-673. <http://dx.doi.org/10.1016/j.solmat.2008.02.037>
- ⁷*Best Research-Cell Efficiencies*. National Renewable Energy Laboratory, National Center for Photovoltaics (rev. 12-18-2014). http://www.nrel.gov/ncpv/images/efficiency_chart.jpg
- ⁸Green, M. A., K. Emery, Y Hishikawa, et al. "Solar Cell Efficiency Tables (Version 45)." *Progress in Photovoltaics: Research and Applications*, vol. 23, no. 1 (2015): 1–9. <http://onlinelibrary.wiley.com/doi/10.1002/pip.2573/full>
- ⁹Green, M. A. "Crystalline and Thin-film Silicon Solar Cells: State of the Art and Future Potential." *Solar Energy* 74, no. 3 (2003): 181-192. <http://www.sciencedirect.com/science/article/pii/S0038092X03001877>
- ¹⁰Wang, S., B. D. Weil, Y. Li, et al. "Large-area Free-standing Ultrathin Single-crystal Silicon as Processable Materials." *Nano Letters* 13, no. 9 (2013): 4393-4398. <http://pubs.acs.org/doi/abs/10.1021/nl402230v>
- ¹¹Wang, A., J. Zhao, S. R. Wenham, and M. A. Green. "21.5% Efficient Thin Silicon Solar Cell." *Progress in Photovoltaics: Research and Applications* 4, no. 1 (1996): 55-58. [http://onlinelibrary.wiley.com/doi/10.1002/\(SICI\)1099-159X\(199601/02\)4:1%3C55::AID-PIP111%3E3.0.CO;2-P/abstract](http://onlinelibrary.wiley.com/doi/10.1002/(SICI)1099-159X(199601/02)4:1%3C55::AID-PIP111%3E3.0.CO;2-P/abstract)
- ¹²Luque, A., and S. Hegedus, eds. *Handbook of Photovoltaic Science and Engineering*. John Wiley & Sons, 2011. <http://onlinelibrary.wiley.com/book/10.1002/9780470974704>
- ¹³Gordon, I., F. Dross, V. Depauw, et al. "Three Novel Ways of Making Thin-film Crystalline-silicon Layers on Glass for Solar Cell Applications." *Solar Energy Materials and Solar Cells* 95 (2011): S2-S7. <http://www.sciencedirect.com/science/article/pii/S0927024810006744>
- ¹⁴Petermann, J. H., D. Zielke, J. Schmidt, et al. "19%-Efficient and 43 μm-Thick Crystalline Si Solar Cell from Layer Transfer Using Porous Silicon." *Progress in Photovoltaics: Research and Applications* 20, no. 1 (2012): 1-5. <http://onlinelibrary.wiley.com/doi/10.1002/pip.1129/abstract>
- ¹⁵Kobayashi, E., N. Kusunoki, Y. Watabe, et al. "Epitaxially Grown Wafer Based Silicon Heterojunction Cells." 6th World Conference on Photovoltaic Energy Conversion (WCPEC-6) *Technical Digest*. Kyoto. (Nov 23-27, 2014).
- ¹⁶Green, M. A. "Polycrystalline Silicon on Glass for Thin-film Solar Cells." *Applied Physics A* 96, no. 1 (2009): 153-159. <http://link.springer.com/article/10.1007%2Fs00339-009-5090-9>
- ¹⁷Green, M. A., P. A. Basore, N. Chang, et al. "Crystalline Silicon on Glass (CSG) Thin-Film Solar Cell Modules." *Solar Energy* 77, no. 6 (2004): 857-863. <http://www.sciencedirect.com/science/article/pii/S0038092X04001641>
- ¹⁸Varlamov, S., J. Dore, R. Evans, et al. "Polycrystalline Silicon on Glass Thin-film Solar Cells: A Transition from Solid-phase to Liquid-phase Crystallised Silicon." *Solar Energy Materials and Solar Cells* 119 (2013): 246-255.
- ¹⁹Yablonovitch, E., T. Gmitter, J. P. Harbison, and R. Bhat. "Extreme Selectivity in the Lift-off of Epitaxial GaAs Films." *Applied Physics Letters* 51, no. 26 (1987): 2222-2224. <http://dx.doi.org/10.1063/1.98946>

- ²⁰Jones-Albertus, R., E. Becker, R. Bergner, et al. "Using Dilute Nitrides to Achieve Record Solar Cell Efficiencies." *MRS Proceedings*, vol. 1538, 161-166. Cambridge University Press. (May 2013). <http://dx.doi.org/10.1557/opl.2013.656>
- ²¹King, R. R., D. C. Law, K. M. Edmondson, et al. "40% Efficient Metamorphic GaInP/GaInAs/Ge Multijunction Solar Cells." *Applied Physics Letters* 90, no. 18 (2007): 183516-183516. <http://dx.doi.org/10.1063/1.2734507>
- ²²Chiu, P.T., D. C. Law, R. L. Woo, et al. "Direct Semiconductor Bonded 5J Cell for Space and Terrestrial Applications." *IEEE Journal of Photovoltaics* 4, no. 1, (January 2014): 493-497. <http://dx.doi.org/10.1109/JPHOTOV.2013.2279336>
- ²³King, R. R., D. Bhusari, D. Larrabee, et al. "Solar Cell Generations Over 40% Efficiency." *Progress in Photovoltaics: Research and Applications* 20, no. 6 (September 2012): 801-815. <http://onlinelibrary.wiley.com/doi/10.1002/pip.1255/pdf>
- ²⁴Kim, Hyung Chul, Vasilis Fthenakis, Jun-Ki Choi, and Damon E. Turney. "Life Cycle Greenhouse Gas Emissions of Thin-Film Photovoltaic Electricity Generation." *Journal of Industrial Ecology* 16, no. s1 (2012): S110-S121. <http://onlinelibrary.wiley.com/doi/10.1111/j.1530-9290.2011.00423.x/pdf>
- ²⁵Hsu, D. D., P. O'Donoghue, V. Fthenakis, et al. "Life Cycle Greenhouse Gas Emissions of Crystalline Silicon Photovoltaic Electricity Generation." *Journal of Industrial Ecology* 16, no. s1 (2012): S122-S135. <http://onlinelibrary.wiley.com/doi/10.1111/j.1530-9290.2011.00439.x/pdf>
- ²⁶Staebler, D. L., and C. R. Wronski. "Reversible Conductivity Changes in Discharge-Produced Amorphous Si." *Applied Physics Letters* 31, no. 4 (1977): 292-294. <http://dx.doi.org/10.1063/1.89674>
- ²⁷Fthenakis, V. and K. Zweibel. "CdTe PV: Real and Perceived EHS Risks." *Prepared for the National Center for Photovoltaics and Solar Program Review Meeting*. NREL/CP-520-33561. (May 2003). <http://www.nrel.gov/docs/fy03osti/33561.pdf>
- ²⁸Wang, W., M. T. Winkler, O. Gunawan, et al. "Device Characteristics of CZTSSe Thin-Film Solar Cells with 12.6% Efficiency." *Advanced Energy Materials* 4, no. 7 (2014). <http://onlinelibrary.wiley.com/doi/10.1002/aenm.201301465/pdf>
- ²⁹Kim, H.-S., C.-R. Lee, J.-H. Im, et al. "Lead Iodide Perovskite Sensitized All-solid-state Submicron Thin Film Mesoscopic Solar Cell with Efficiency Exceeding 9%." *Scientific Reports* 2 (2012): 591-597. <http://www.nature.com/srep/2012/120821/srep00591/pdf/srep00591.pdf>
- ³⁰Lee, M. M., J. Teuscher, T. Miyasaka, T. N. Murakami, and H. J. Snaith. "Efficient Hybrid Solar Cells Based on Meso-superstructured Organometal Halide Perovskites." *Science* 338, no. 6107 (2012): 643-647. <http://www.sciencemag.org/content/338/6107/643.full>
- ³¹Burschka, J., N. Pellet, S.-J. Moon, et al. "Sequential Deposition as a Route to High-Performance Perovskite-sensitized Solar Cells." *Nature* 499, no. 7458 (July 2013): 316-319. <http://www.nature.com/nature/journal/v499/n7458/pdf/nature12340.pdf>
- ³²Zhou, H., Q. Chen, G. Li, et al. "Interface Engineering of Highly Efficient Perovskite Solar Cells." *Science* 345, no. 6196 (2014): 542-546. <http://www.sciencemag.org/content/345/6196/542>
- ³³Liu, M., M. B. Johnston, and H. J. Snaith. "Efficient Planar Heterojunction Perovskite Solar Cells by Vapour Deposition." *Nature* 501, no. 7467 (September 2013): 395-398. <http://www.nature.com/nature/journal/v501/n7467/pdf/nature12509.pdf>
- ³⁴Yella, A., H-W Lee, H. N. Tsao, et al. "Porphyrin-sensitized Solar Cells with Cobalt (II/III)-based Redox Electrolyte Exceed 12 Percent Efficiency." *Science* 334, no. 6056 (2011): 629-634. <http://dx.doi.org/10.1126/science.1209688>
- ³⁵Green, M. A. "Third Generation Photovoltaics: Ultra-high Conversion Efficiency at Low Cost." *Progress in Photovoltaics: Research and Applications* 9, no. 2 (2001): 123-135. <http://onlinelibrary.wiley.com/doi/10.1002/pip.360/pdf>
- ³⁶Conibeer, G. "Third-generation Photovoltaics." *Materials Today* 10, no. 11 (November 2007): 42-50. [http://dx.doi.org/10.1016/S1369-7021\(07\)70278-X](http://dx.doi.org/10.1016/S1369-7021(07)70278-X)
- ³⁷Munsell, M. "Could First Solar's Thin Film Beat Silicon PV on Efficiency? Average Commercial Module Efficiency, First Solar vs. Crystalline Silicon, 2009-2017E." *PV Pulse*. Greentech Media. (April 11, 2014). <http://www.greentechmedia.com/articles/read/could-first-solars-thin-film-beat-silicon-pv-on-efficiency>
- ³⁸*Module Price Index*, pvXchange. (2014). <http://www.pvxchange.com/priceindex/Default.aspx?langTag=en-GB>
- ³⁹Schmalensee, R. *The Performance of U.S. Wind and Solar Generating Plants*. MIT Center for Energy and Environmental Policy Research. CEEPR WP 2013-12. (September 2013). <http://web.mit.edu/ceepr/www/publications/workingpapers/2013-012.pdf>

⁴⁰“Abundance of Elements in the Earth’s Crust and in the Sea.” *CRC Handbook of Chemistry and Physics, 95th Edition*, Taylor and Francis Group, LLC. 14-18 (2014). www.hbcnetbase.com

⁴¹*Global Market Outlook for Photovoltaics 2014-2018*, European Photovoltaic Industry Association. (2014). http://www.epia.org/fileadmin/user_upload/Publications/44_epia_gmo_report_ver_17_mr.pdf

⁴²*Photovoltaics Report*, Fraunhofer ISE. (2014). <http://www.ise.fraunhofer.de/en/renewable-energy-data>

⁴³Rech, B., C. Beneking, S. Wieder, et al. “Challenges in a-Si PV Technology Transfer: From Research Lab to Production Line.” *2nd World Conference and Exhibition on Photovoltaic Solar Energy Conversion: Proceedings of the International Conference held at Vienna, Austria*. (July 1998). 91–396. <http://bookshop.europa.eu/en/2nd-world-conference-on-photovoltaic-solar-energy-conversion-pbCLNO18656/>

⁴⁴*Electric Power Monthly with Data for December 2013*, U.S. Energy Information Administration. (February 2014). http://www.eia.gov/electricity/monthly/current_year/february2014.pdf

The hyperlinks in this document were active as of April 2015.

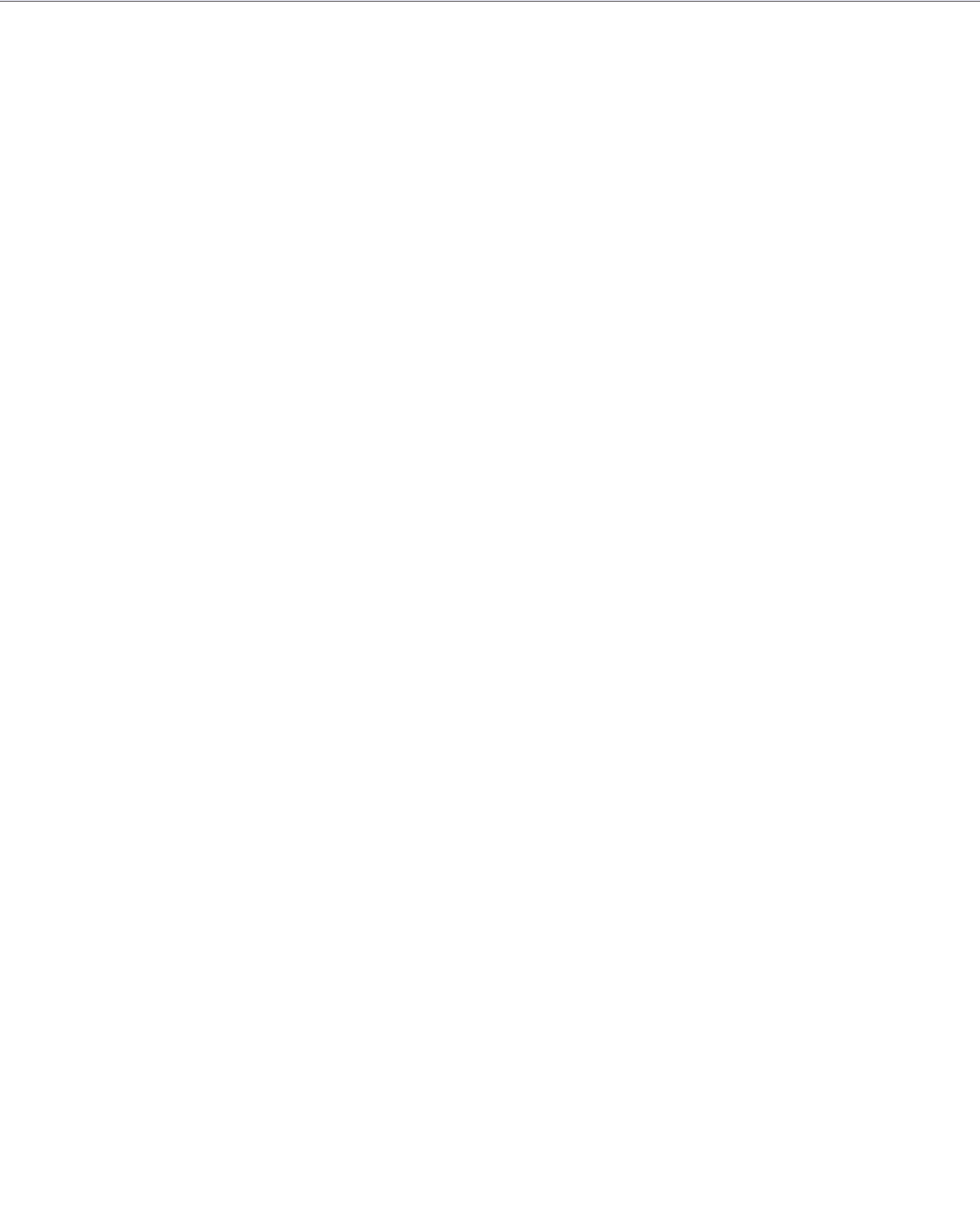

Chapter 3 – Concentrated Solar Power Technology

Concentrated solar power (CSP), also referred to as solar thermal power, generates electricity by using sunlight to heat a fluid. The heated fluid is then used to create steam that drives a turbine-generator set. Because CSP systems heat a fluid prior to generating electricity, thermal energy storage can be readily incorporated into the design of CSP plants, making them a potential source of “dispatchable” renewable power. Furthermore, because the power generation unit in a CSP system is similar to that of current fossil-fuel thermal power systems (i.e., steam cycle, steam turbine and generator), CSP technology is well suited for use in hybrid configurations with fossil-fuel plants, particularly natural gas combined cycle plants.

This chapter describes the basic principles by which CSP systems operate and the scale of electricity generation that CSP could provide in the United States. After reviewing current CSP technologies and identifying their strengths, the chapter discusses remaining technical challenges associated with each technology. It details how energy storage can be readily integrated with CSP plants and how this can enable better asset utilization and reduce the challenges of intermittency associated with solar power generation. Finally, the chapter describes the attractiveness of hybrid systems in which CSP is paired with fossil-fired generation and other thermal systems such as desalination plants.

3.1 BASICS OF CONCENTRATED SOLAR POWER

CSP systems employ mirrors to direct and focus solar radiation on a heat transfer fluid. This fluid, which may be a synthetic oil, molten salt, or steam, is then used to generate electricity either by direct expansion through a turbine (if the heat transfer fluid is the same as the fluid passing through the turbine) or via heat

Thermal energy storage can be readily incorporated into the design of CSP plants, making them a potential source of “dispatchable” renewable power.

transfer to a separate fluid (often steam or organic vapor), which expands in a turbine and generates electricity. The two process steps that most affect overall CSP plant efficiency are the solar-to-heat step within the solar collector and the heat-to-electricity step in the power generation block.

CSP system architectures that focus the solar energy to a point, rather than on a line, can yield higher working fluid temperatures, and thus have an inherently higher theoretical efficiency. As discussed later in this chapter, however, their potential for higher efficiency can come with added system complexity and cost. In practice both line- and point-focus systems have been deployed depending on the specific techno-economic requirements of a project.

BOX 3.1 THE THERMODYNAMIC CYCLE UNDERPINNING CSP-BASED POWER GENERATION

Along with much of the thermal power generation capacity currently installed worldwide, today's CSP systems use the Rankine thermodynamic cycle, in which thermal energy (whether from fossil-fuel combustion, nuclear fission, or solar heating) is converted to mechanical work via a turbine, which in turn drives an electricity generator. In that sense, CSP power generation is not based on a new technology. In fact, Rankine-based power cycles have been in operation and under continual refinement for more than a century.

The Rankine cycle involves a fluid (working fluid) circulating within a closed cycle. In the first stage of the cycle the working fluid is pressurized in its liquid phase. Heat is then supplied to the fluid. This converts the fluid

to its vapor phase (steam if water is the working fluid). The high-pressure vapor is expanded through a turbine, thus converting thermal energy to mechanical energy. The spinning turbine is coupled to a generator set to produce electricity. The low-pressure vapor leaving the turbine is cooled and condenses back to its liquid phase thus completing the cycle.

The theoretical efficiency of the Rankine cycle is defined as the amount of mechanical work produced in the turbine per unit of thermal energy used (in the form of heat applied to the working fluid). A key constraint that limits the achievable efficiency of the Rankine cycle is the temperature difference between the hot and cold stages of the working fluid. Theoretical efficiency increases if either the temperature of heated working fluid (in its vapor state) is increased or the temperature of cooled working fluid (in its liquid state) is decreased, or both.

CSP has a range of characteristics that make it an attractive power generation pathway. First, like photovoltaic (PV) technology, CSP offers a means of exploiting the world's very large and broadly distributed solar resource (see discussion in Chapter 1). Second, because CSP involves a solar-to-heat conversion step, it is possible — and in fact relatively straightforward — to incorporate high-efficiency thermal energy storage in the architecture of a CSP plant. This means CSP plants can provide “dispatchable” renewable electricity. The third compelling feature of CSP technology is the ease with which it can be hybridized with other

thermal generation options, such as fossil-fuel combustion, thus providing a flexible power plant that can exploit the solar resource while also being fully dispatchable at night and during other periods of low solar insolation.

Along with its inherently attractive features, however, CSP suffers from some serious shortcomings. First, CSP systems can only exploit direct solar radiation.ⁱ This contrasts with non-concentrating PV systems that can also exploit diffused sunlight. As a result, intermittent cloud cover or hazy skies can affect generation from CSP plants more than generation from PV systems. Adding thermal storage (discussed later in this chapter) helps alleviate this issue. However, storage also adds capital and operating costs, which may or may not be economically justifiable.

CSP has a range of characteristics that make it an attractive power generation pathway.

ⁱDirect solar radiation, also called beam radiation, is solar radiation that travels on a straight line from the sun to the surface of Earth without being scattered by clouds or particles in the atmosphere.

Second, CSP is very sensitive to scale. Specifically, CSP systems need to be large (tens of megawatts or larger) to approach their techno-economic optimum in terms of maximizing efficiency and minimizing costs. This contrasts with PV technology, where system cost depends on scale but efficiency does not. The practical result is that developing a commercial CSP plant requires a very large capital investment and presents financial risks that only a limited set of investors are capable of taking on. As more CSP deployment occurs, the investment risk profile will change and a larger pool of investors will emerge. However, this pool will still be much smaller than that for PV systems, which can be deployed at scales ranging anywhere from a few kilowatts to hundreds of megawatts.

A third challenge for CSP deployment is the large land and water requirements that accompany any CSP plant of practical scale. Based on experiences with recently commissioned CSP plants, including NRG's California Valley Ranch plant and Abengoa's Solana plant, seven to eight acres of land are needed per megawatt (MW) of capacity. Given that an optimum CSP plant is typically hundreds of megawatts in size, any practical CSP project will need several thousand acres of land, a requirement that limits siting options. This land-use constraint on large-scale deployment is primarily due to the low energy density of sunlight — hence it is common to both CSP and PV technologies.

Both CSP and PV facilities require water — for cleaning mirrors, in the case of CSP plants, and panels, in the case of PV plants. However, water requirements for cleaning are minor compared to the 2.9–3.2 liters per kilowatt-hour (kWh) of water needed for cooling purposes at contemporary wet-cooled trough CSP plants.¹ This level of water demand is about four times

higher than the cooling water needs of a modern combined cycle natural gas plant with comparable output. A trough CSP plant requires more cooling water than a conventional thermal power generation plant because the steam (working fluid) it generates is at

Developing a commercial CSP plant requires a very large capital investment and presents financial risks that only a limited set of investors are capable of taking on.

a lower temperature. As a result, more steam needs to be condensed to produce the same amount of power, which in turn leads to higher cooling water demand. Solar tower CSP systems do have somewhat lower water requirements (because they produce higher working fluid temperatures), but their cooling needs are still very significant, particularly since such plants are almost universally located in arid regions to avoid clouds. Using air for cooling can eliminate CSP's cooling water needs; however, an air-cooled architecture reduces the power output of the plant and adds significant costs.

Combining the large land requirements of CSP plants with the need for this land to be flat and subject to high levels of direct sunlight restricts the land base suitable for siting CSP. In the United States the vast majority of CSP-suitable land is located in the Southwest. Recent studies have concluded that in this region, between 54,000 and 87,000 square miles of land may be suitable for CSP plants.^{2,3} Depending on assumptions about system capacity factorⁱⁱ and thermal storage, this land base could support between 6.8 and 7.4 terawatts (TW) of generation capacity. These are enormous numbers compared to the nameplate capacity of the entire U.S. electricity generation fleet, which currently totals 1.15 TW. Of course, it is also

ⁱⁱCapacity factor is defined as the ratio of the actual amount of electricity generated by a power plant over a given period to the maximum amount of electricity that could be produced by the same plant over the same time period if the plant were to operate at its full nameplate capacity.

worth noting that 54,000 square miles is an area almost exactly the size of the state of New York. The geographic distribution of CSP-suitable land across the southwestern United States, as

identified by the U.S. Department of Energy’s National Renewable Energy Laboratory (NREL) is shown in Figure 3.1.⁴ Table 3.1 provides a state-by-state breakdown of

Figure 3.1 Distribution of CSP-Suitable Land and Associated Solar Insolation Across the Southwestern United States

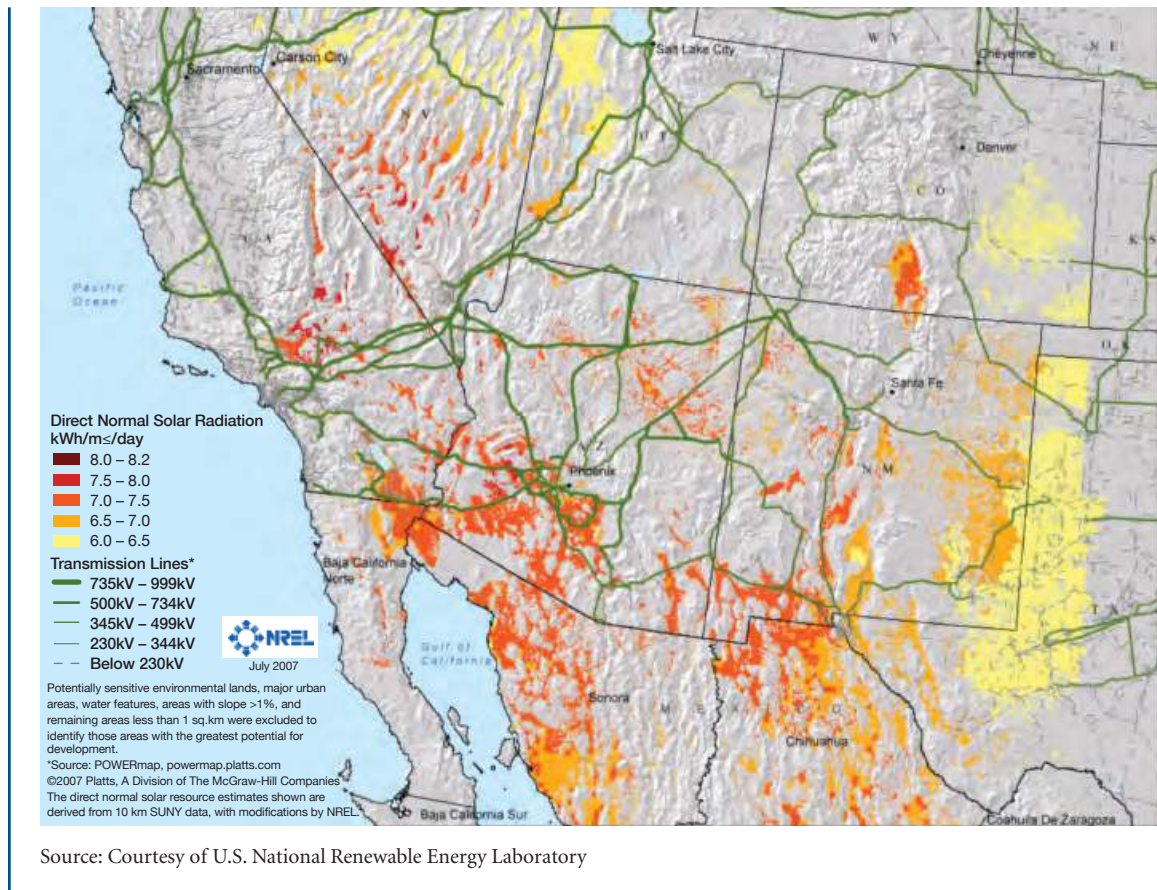

Table 3.1 Total Available Land Area and Corresponding Capacity Potential for CSP in the Southwestern United States

State	Available Area (mi ²)	Capacity (GW)
Arizona	19,300	2,468
California	6,900	877
Colorado	2,100	272
Nevada	5,600	715
New Mexico	15,200	1,940
Texas	1,200	149
Utah	3,600	456
Total	53,900	6,877

Data from Mehos and Kearney²

CSP-suitable land area and associated resource potential in terms of CSP generating capacity.

Despite the enormity of the theoretical CSP resource base in the American Southwest, significant practical hurdles stand in the way of exploiting this potential. In particular, since the resource is geographically far from major electricity demand centers in the Midwest and Northeast, any large-scale CSP deployment would require substantial expansion of high-voltage transmission capacity. For this reason, early CSP plants have been located near large load centers in the Southwest.

FINDING

Because CSP requires large amounts of direct solar radiation, the best U.S.-based resources for this technology are concentrated in the desert Southwest. This means that the availability of high-voltage transmission connections to major electricity-consuming centers is critical to any discussion of large-scale CSP development.

3.2 CONCENTRATED SOLAR POWER TECHNOLOGIES

Fundamentally, a CSP plant is simply a thermal power plant where solar-derived heat is converted into electricity subject to thermodynamic efficiency limitations. Since the temperatures produced by collecting the sun's heat in today's CSP designs do not reach the same levels as the temperatures achieved in modern coal or natural gas plants, CSP's heat-to-electricity conversion efficiency is lower than that of fossil-fired power plants.

Importantly though, this efficiency deficit is not inherent: to the extent that advances in system design and materials enable CSP systems to achieve higher temperatures, the efficiency differential compared to fossil-fired systems could shrink substantially.

Despite the enormity of the theoretical CSP resource base in the American Southwest, significant practical hurdles stand in the way of exploiting this potential.

Figure 3.2 provides a quantitative illustration of energy flows and losses through a contemporary CSP system from incident solar radiation to generated electricity delivered to the grid. In this example, less than half (42%) of the total incident solar energy is delivered to the boiler as heat as a result of energy losses associated with the CSP system's mirror array and thermal receiver. Owing to the thermodynamics of the Rankine cycle, only 40% of this captured thermal energy is then converted to electricity, meaning that after plant power needs are met, the CSP plant's net electrical energy output represents just 16% of the incident solar energy. This example provides a clear illustration of the substantial opportunity that exists to improve overall CSP efficiency. Solar-to-heat conversion losses can be reduced through improved mirror systems and the design of thermal receivers with lower convective and re-radiative losses, while designs that allow for higher working fluid temperatures will improve heat-to-electricity efficiency. Whereas the overall efficiency of today's advanced fossil-fuel generation plants, which use combined cycle gas turbine (CCGT) technology,ⁱⁱⁱ is about 55%, the overall efficiency of the CSP plant in Figure 3.2 is 16%. Note that the steam turbine portions of both the CCGT and CSP plants are comparable in efficiency.

ⁱⁱⁱCCGT plants, which are the most efficient fossil-fuel generation technology available today, use two thermodynamic cycles, a Brayton cycle (see Section 3.6) for the gas turbine and a Rankine cycle for the steam turbine.

Figure 3.2 Efficiency of a Typical CSP Plant^{iv}

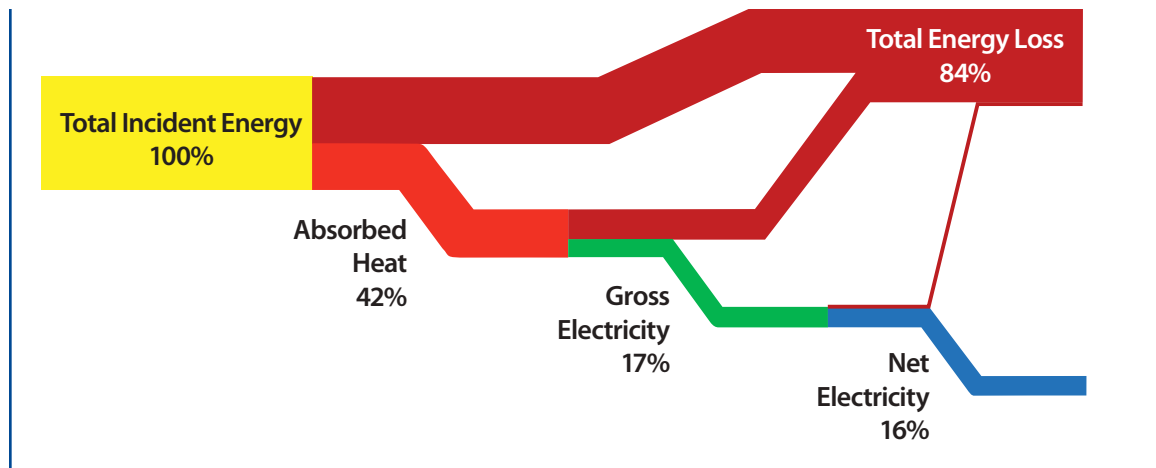

As already noted, two broad design paradigms exist for CSP systems: line focus and point focus. As the names suggest, line-focus systems concentrate sunlight on a line, while point-focus systems concentrate light to a point. Because the latter approach is able to achieve higher working fluid temperatures, point-focus designs can achieve higher efficiencies than line-focus designs.

Today there are five primary types of CSP technology either in operation or the subject of serious research and development efforts: parabolic trough (line-focus design), solar tower (point-focus design), linear Fresnel (low-cost and more reliable variation of line-focus design), beam down (recent low-cost variation of point-focus design), and Stirling dish. The important features of each technology are summarized in Table 3.2 later in this chapter. It should be noted that the Stirling dish

technology is fundamentally different from all other CSP technologies, as it does not utilize a Rankine cycle to convert thermal energy to electricity. Most CSP development to date has centered on the first two technologies — parabolic trough and solar tower. However, each of the five main CSP technologies brings with it a distinct set of technical and economic advantages and challenges.

Parabolic Trough Design

In this type of CSP plant, sunlight is focused by long parabolic trough mirrors onto a tube at the focal line of the mirror. A heat transfer fluid, typically synthetic oil, is heated as it flows through the receiver tubes. The hot fluid is then used to generate steam in a heat exchanger, which, in turn, generates electricity in a conventional Rankine cycle via a steam turbine coupled to a generator set. The parabolic mirrors and heat transfer fluid tubes rotate on one axis during the day to track the sun. Figure 3.3 shows a schematic diagram of a parabolic trough system and a photo of an existing parabolic trough installation.

Point-focus designs can achieve higher efficiencies than line-focus designs.

^{iv}The numbers shown are for a CSP plant as modeled in NREL's System Advisor Model (SAM), version 2014.1.14.⁵ The plant is based on solar tower technology and is located in Daggett, California (see Appendix D for more details).

Figure 3.3 Parabolic Trough CSP Design

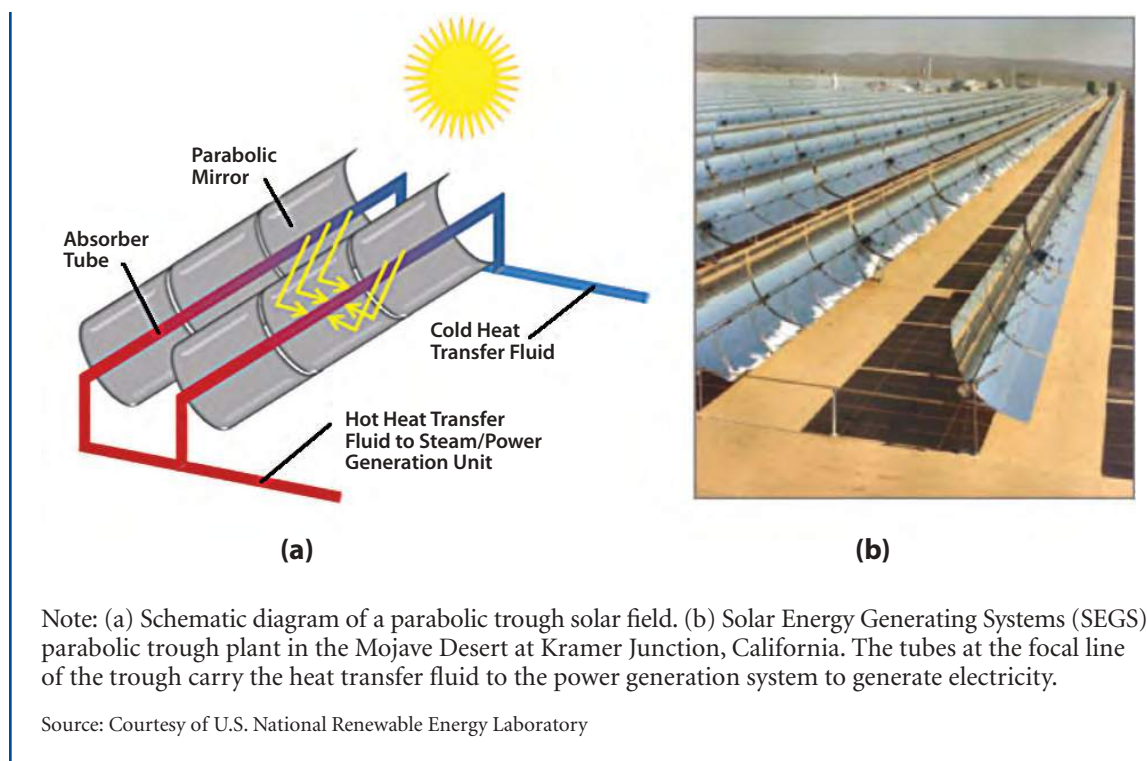

Note: (a) Schematic diagram of a parabolic trough solar field. (b) Solar Energy Generating Systems (SEGS) parabolic trough plant in the Mojave Desert at Kramer Junction, California. The tubes at the focal line of the trough carry the heat transfer fluid to the power generation system to generate electricity.

Source: Courtesy of U.S. National Renewable Energy Laboratory

Advantages

The parabolic trough design is the most mature CSP technology and has been used in the United States since the Solar Energy Generating Systems (SEGS)^v project began coming on line in 1984. Since that time the design has undergone a great deal of optimization. As a result, parabolic trough CSP is now considered a commercial technology. Similar to other solar technologies, parabolic trough technology can be equipped with a tracking system that rotates the mirrors to track the sun as it moves across the sky every day. Alternatively, the parabolic troughs can be adjusted seasonally — this avoids the high cost of adding tracking capability but results in lower overall efficiency.

Disadvantages and Design Limitations

Although it is now a relatively mature technology, parabolic trough CSP has significant drawbacks. The main drawback is high capital cost due to the need for many rows of mirror and collector units to increase the temperature of the heat transfer fluid. Also, parabolic trough systems suffer from problems with convective heat loss and re-radiation, as well as mechanical strain and leakage at moving joints. Some of the operating SEGS plants have experienced these mechanical problems, though they have been resolved with operating experience. Similar operating challenges will no doubt occur in new designs and new operating regimes. Finally, the heat transfer fluid operates at relatively low temperatures (400°C or less), leading to low overall thermodynamic efficiency.

^vThe SEGS project in California consists of nine CSP power-generating facilities, which were constructed between 1984 and 1990.

Solar Tower

The solar tower CSP design consists of an array of heliostats/mirrors directed at a common focal point at the top of a tower (Figure 3.4). As the location of the tower is fixed, all the mirrors must be equipped with a two-axis tracking system to be able to direct sunlight to a central collector at the top of the tower. The height of the tower depends on the geometry of the solar field and the requirement that inner mirrors not block the outer rows. Electricity is generated by direct or indirect steam generation: the direct approach occurs within the tower and the indirect approach involves a heat transfer fluid of synthetic oil, molten salts, or air. The centralized collector design means these systems can attain a higher working fluid temperature, which in turn increases overall system efficiency. For example, solar towers,

which use solar salt as the heat transfer fluid, can operate with fluid temperatures ranging from 250°C to 565°C. The lower and higher temperature limits are set by the freezing and decomposition temperatures of the heat transfer fluid.

Advantages

Because solar towers can utilize a hotter working fluid than troughs, they offer a path to higher efficiency. Additionally, as towers utilize a lower heat transfer surface area, convective losses can be reduced. Finally, as discussed in Section 3.3, higher operating temperatures in the solar tower make it possible to add thermal storage more efficiently because the size (volume) of thermal storage required is smaller. This reduces both the cost and the heat losses of the storage system.

Figure 3.4 Solar Tower CSP Design

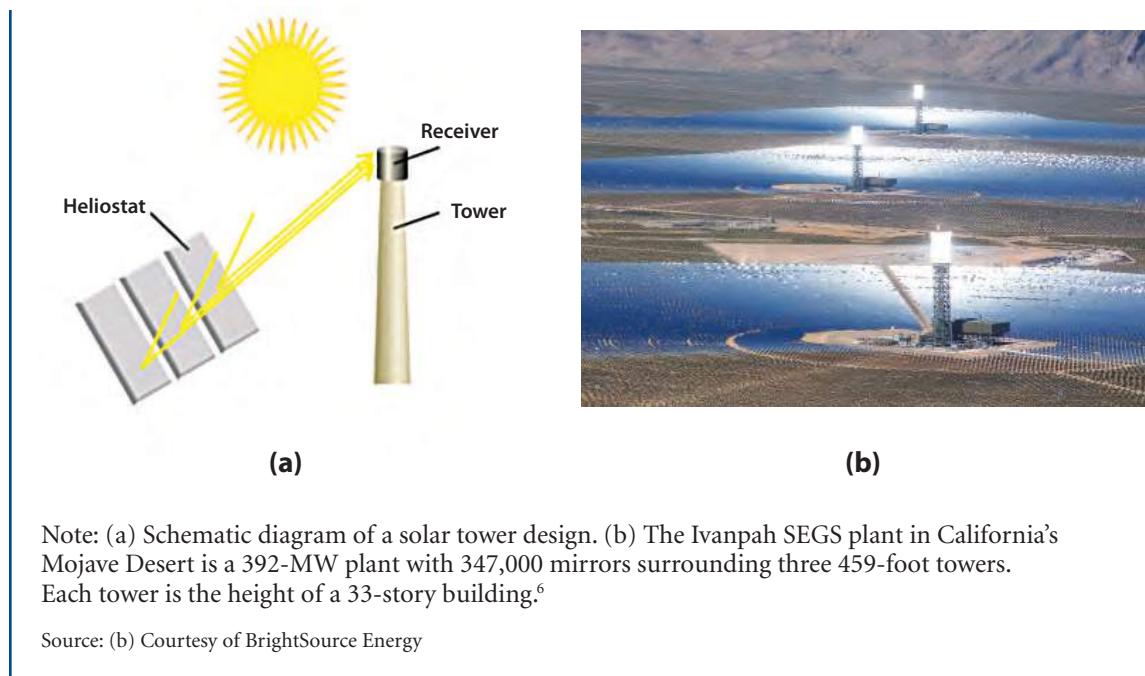

Disadvantages and Design Limitations

The two-axis tracking system is an inherent requirement of the solar tower design; by contrast, mirrors in the trough design can have one-axis tracking or no tracking. Although two-axis tracking makes it possible to collect heat from sunlight more efficiently, it also increases the cost of the solar field. In addition, the solar tower design has been shown to suffer from difficulties in mirror alignment, high maintenance costs, and difficulties with molten salt (such as its high viscosity in tubes and the danger of falling below its freezing point). Furthermore, the receiver fluid temperature can change rapidly with intermittent cloud cover, resulting in intermittent electricity generation and, more importantly, the potential for excessive mechanical strain. There is also less construction and operating experience with towers than with the more mature trough technology.

Finally, careful consideration of potential impacts on local wildlife is important for solar tower installations, particularly in desert regions. For example, it has been reported that the high temperatures generated around the collector in solar tower plants can harm birds flying in the vicinity of the tower. Such impacts will need to be factored into the design of future plants of this type.

FINDING

Point-focus CSP technologies have a higher theoretical efficiency than line-focus technologies because they can achieve higher working-fluid temperatures.

Other CSP Technologies

Compared to trough and solar tower designs, the cost and performance characteristics of other CSP technologies — including beam-down, linear Fresnel, and Stirling dish engine systems — are more uncertain, largely because these technologies are at a different stage of development, and data on their designs and costs are preliminary. This section provides a brief description of these systems; their main characteristics are summarized in Table 3.2 later in this chapter.

Beam-Down CSP

The beam-down CSP system (Figure 3.5) consists of an array of tracking heliostat mirrors that reflect light to a single, centrally located mirror or secondary heliostat atop a tower, which in turn reflects light down to an enclosed, secondary collector. This enclosed collection system may allow for very high-temperature working fluids and thus increased thermodynamic efficiencies. Also, with this design the high cost and inefficiencies associated with having the receiver atop the tower, as is the case in solar tower systems, can be avoided. In this design, the heat transfer and thermal storage fluids^{vi} are the same, which allows for better power dispatch and greatly reduces storage costs. Beam-down technology has not yet been implemented at full plant-size scale. Current technical difficulties include geometry design issues, fabrication and control of the secondary heliostat, loss of light around collectors, and mirror material issues involving reflectivity and thermal strain.

^{vi}The heat transfer fluid is the fluid that circulates in collectors and receiver(s) in trough and solar tower designs, respectively, and that is used to collect the thermal energy of sunlight. The thermal energy storage fluid is a fluid with high heat capacity that is used in the storage system. The heat transfer and thermal energy storage fluids are not necessarily the same, although there are designs in which the same fluid is used for both purposes.

Figure 3.5 Schematic Diagram and Picture of a Solar Beam-Down CSP Design⁷

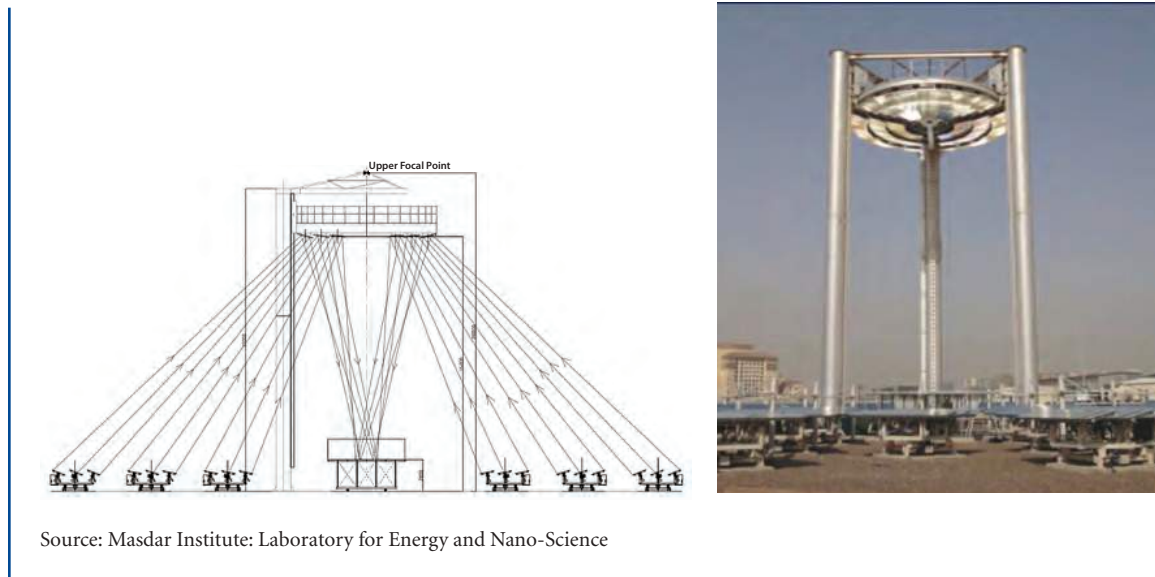

Linear Fresnel CSP

In the linear Fresnel design, flat and/or slightly curved mirrors concentrate sunlight on a stationary tube at the focal line (Figure 3.6). The entire arrangement remains stationary, reducing its average absorption efficiency during a day but making it cheaper, both in capital and operating expenses, when compared with parabolic trough designs. Larger apertures (greater mirror coverage per square meter) are possible with linear Fresnel, and the physical

arrangement of the mirrors results in substantially lower wind loads than trough designs. This design is technologically simple; it also uses a relatively low-temperature working fluid, making it comparatively inexpensive. Construction is also relatively simple. However, because the working fluid operates at a relatively low temperature, the efficiency of linear Fresnel systems is lower than that of other CSP designs such as a solar tower. Newer linear Fresnel designs may allow use of higher-temperature molten salts.⁸

Figure 3.6 Linear Fresnel Collector Design⁹

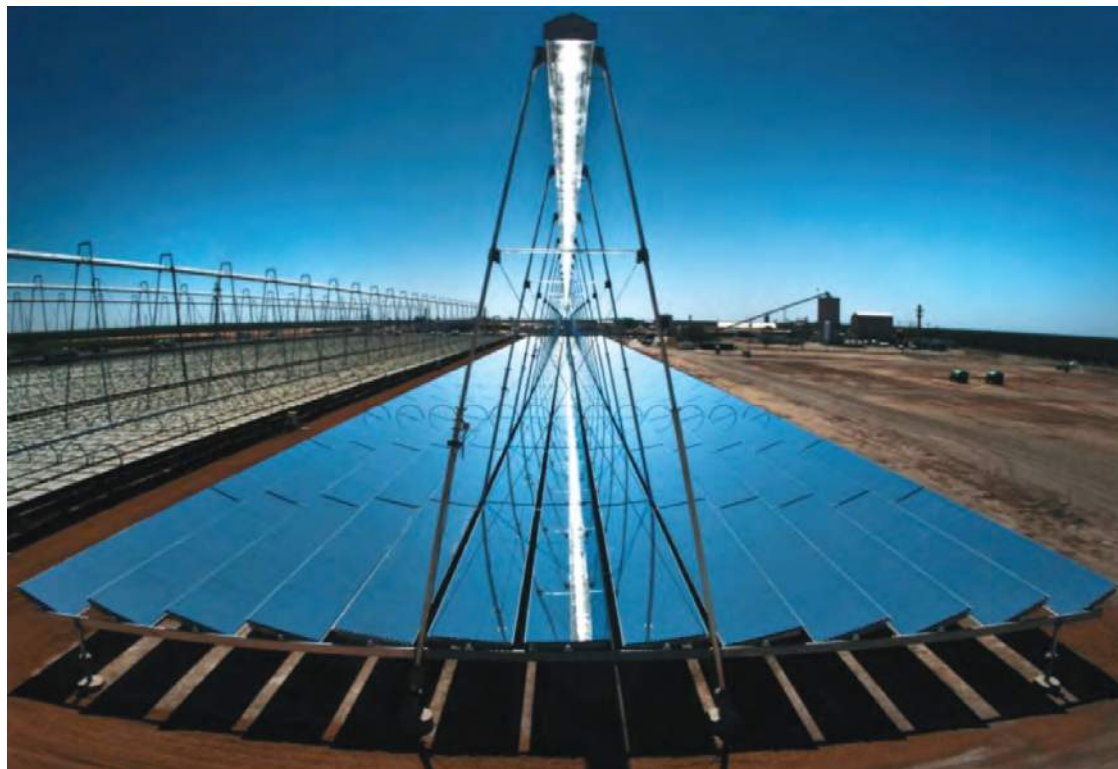

Source: AREVA Solar Inc., 2010

Stirling Dish Engines

This CSP technology uses dish-shaped mirror arrays to focus sunlight onto a Stirling engine^{vii} at the focal point of the dish (Figure 3.7). Each unit is rated at modest power output (10–25 kW), so the technology is modular — a potential advantage. The efficiency of Stirling engines can approach the maximum theoretical thermodynamic efficiency of a heat engine — the so-called Carnot efficiency. As a result, this design has the highest potential conversion efficiency of any CSP technology. Furthermore, high operating temperatures can be achieved in larger units (>30 kW) by concentrating a larger

array of mirrors on a single heat engine, thereby increasing efficiency even further. Stirling engines are efficient, but because these systems require a separate engine with every dish, they are capital intensive and have high operating and maintenance (O&M) costs. In addition, there is currently no simple energy storage option for Stirling dish engine technologies — a significant drawback. Stirling dish engine systems involving tens of thousands of mirror arrays acting in parallel at a centralized location have been proposed. These types of systems have been successfully tested, but have seen limited commercial use.

^{vii}A Stirling engine is a type of heat engine where a working fluid (gas or liquid) operates between a hot expansion cylinder and a cool compression cylinder.

Figure 3.7 Stirling Dish Engine System¹⁰



Source: Courtesy of the U.S. National Renewable Energy Laboratory

Because of the expense of Stirling engines, research and development efforts are underway to explore the use of Brayton micro-turbines as a substitute for Stirling engines in dish CSP designs.¹¹ Brayton micro-turbines are substantially less expensive, but are also somewhat less efficient, with efficiencies between 25% and 33% as compared with 42% for the best Stirling engines.

3.3 THERMAL ENERGY STORAGE

Because CSP technologies initially capture solar energy as heat, the opportunity exists to store this heat for a period of time prior to generating electricity. Roundtrip efficiencies^{viii} for thermal energy storage can be quite high, on the order of 95% or higher, which makes the storage option for CSP much more attractive than for PV, where battery or fuel-production technologies are needed to implement storage. Given the significant advantage of energy-storage capability in currently employed CSP technologies, this section describes the most likely near-term storage technologies for CSP and the benefits

^{viii}The term “roundtrip efficiency” refers to the percentage of the input thermal energy to the storage system that can be collected back after accounting for all energy losses.

associated with storage. Section 3.5 discusses opportunities to pair CSP technologies with other thermal plants in hybrid configurations, especially with natural gas plants, which can be used to supplement solar power generation as well as to improve the dispatchability of produced power.

The energy storage capacity of a CSP plant can be expressed in terms of the number of hours that the plant can operate at its design capacity using only the heat from the storage system. For example, thermal storage of six hours means that the CSP plant can operate for six hours at its nameplate capacity using only the thermal energy from the storage system (with no energy from the solar field).

Short-Term Thermal Energy Storage

Two types of short-term energy storage are already in commercial use with CSP. The first exploits the inherent thermal inertia of the heat transfer fluid, especially in the piping of parabolic trough CSP plants. This short-term storage is important for damping fluctuations in power output associated with short-term disturbances such as passing clouds.

The second short-term thermal storage mechanism uses steam accumulators — pressurized vessels that are used to store steam. These accumulators are ideal for short-term buffer storage and have the advantage of using a simple, inexpensive storage medium. Because this option requires pressurized tanks, however, storage is limited to small capacities — on the order of an hour of storage. Furthermore, steam accumulators have the disadvantage of being inefficient and producing variable-pressure steam. The PS10 CSP plant in Spain uses four steam accumulators to provide 20 megawatt-hours (MWh) of storage.

Longer-Term Thermal Energy Storage

Figure 3.8 illustrates the basic strategy for longer-term thermal energy storage for CSP technologies; specifically, it shows a process flow chart for a CSP plant with a two-tank indirect thermal energy storage system. In this example, the hot heat transfer fluid (HTF) from the receiver or collectors of a solar tower or parabolic trough plant can either be sent directly to generate steam or it can be diverted to a heat exchanger to heat a thermal energy storage (TES) fluid, typically a molten salt. In this mode of operation, fluid from the cold salt tank is heated as it is pumped to the hot salt storage tank. The fluid from the hot storage tank can be used to heat the HTF when production from the solar field is not adequate. The two-tank indirect arrangement is currently in use at many CSP plants, including the Solana plant in the United States and the Arenales plant in Spain. The Solana plant has six hours of storage (see Table 3.3) and the Arenales plant has seven hours of storage. This two-tank indirect system represents the current practice in thermal energy storage and has important advantages in terms of ease of operation and the ability to provide very large storage capacities. On the other hand, the two-tank indirect approach is expensive and incurs efficiency losses because of heat losses in the HTF-to-TES fluid heat exchanger. As a result, a number of other thermal storage systems are under consideration and at various stages of development.

Figure 3.8 Process Flow Diagram for a CSP System with a Two-Tank Indirect Energy Storage System and Fossil-Fuel Backup Boiler

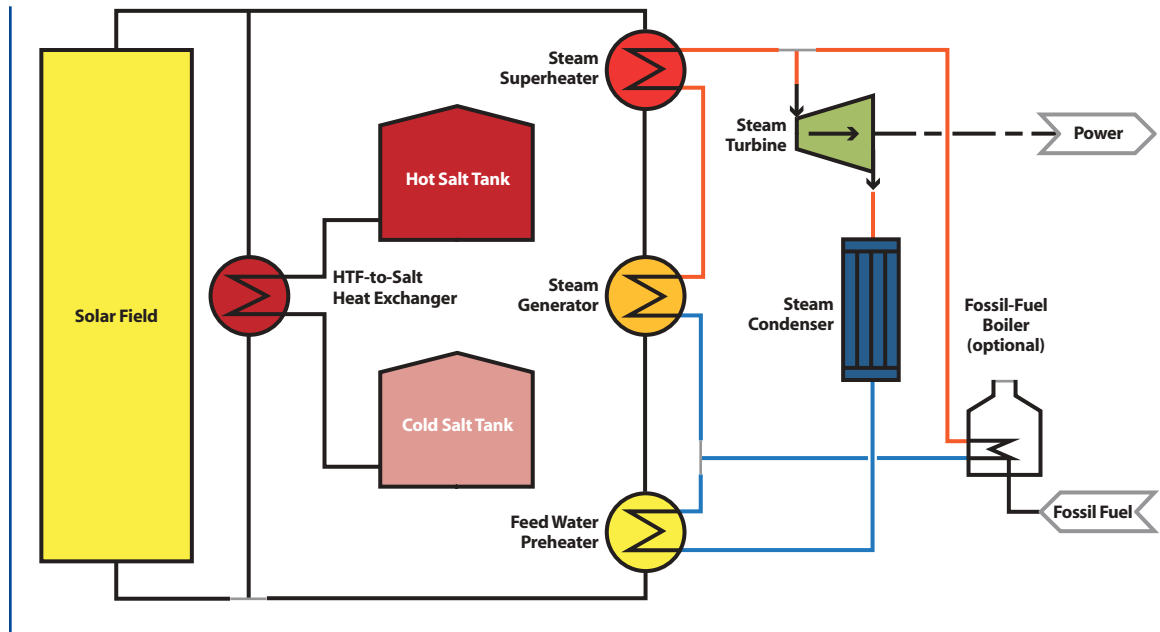

The simplest variation on the two-tank indirect system is the two-tank direct configuration, which eliminates the heat exchanger and the direct connection between hot and cold storage tanks. Instead, the hot and cold storage tanks are inserted directly in series, with pipes coming from and to the solar field, respectively. Apart from the obvious advantage of eliminating the need for a heat exchanger to transfer thermal energy from the HTF to the TES fluid, the two-tank direct system can operate at very high temperatures and store large amounts of energy. These two advantages result from using high-temperature molten salts for both HTF and TES functions. The use of molten salts carries with it the disadvantage of having to prevent the salt from freezing, e.g., by running electrical tracing in the piping. Between 1985

and 1999, the SEGS I facility in California used a two-tank direct TES, but with a flammable mineral oil for the HTF and TES rather than a molten salt. This fluid has not subsequently been used. Recent CSP plants use the two-tank direct configuration as the storage system; for example, the Crescent Dunes Solar Energy project in Nevada uses molten salt in a two-tank direct arrangement to provide ten hours of thermal energy storage.¹²

The use of concrete blocks for TES in parabolic trough systems has been demonstrated at small scale. Graphite blocks have been investigated as both the receiver material and TES medium. The latter approach would be limited to relatively small systems given the volume and cost of the required amount of graphite.

System Benefits of Thermal Energy Storage

The ability to provide effective thermal storage as part of a CSP system design yields several benefits including: (1) the ability to transform CSP from an intermittent to a dispatchable generation source; (2) the ability to better match electricity demand; (3) the extended utilization and increased efficiency of a CSP facility's power generation unit; and (4) the ability to increase the annual capacity factor of the CSP plant. The basic benefit of thermal energy storage in CSP is illustrated in Figure 3.9, which compares the solar resource, the possible output of a CSP plant with storage, and total electricity demand over the course of a day.

The figure illustrates the advantages of storage listed above. First, the availability of storage provides buffering to smooth out the operation of the power block from variations in solar

insolation due to passing clouds. This smoothing allows the power block to operate at a more constant rate and closer to maximum efficiency. This can result in lower O&M costs, longer life

The ability to provide effective thermal storage as part of a CSP system design yields several benefits.

for the power block, and a lower levelized cost of electricity (LCOE). Second, storage makes it possible to extend the delivery of electricity to cover the broadest period of peak demand and highest electricity prices. In the extreme, this might ultimately enable CSP to function as baseload power. Third, the timing of peak electricity generation can be shifted away from the time of peak solar insolation to better match peak demand, even with limited storage capacity.

Figure 3.9 Use of Thermal Energy Storage in a CSP Plant^{ix}

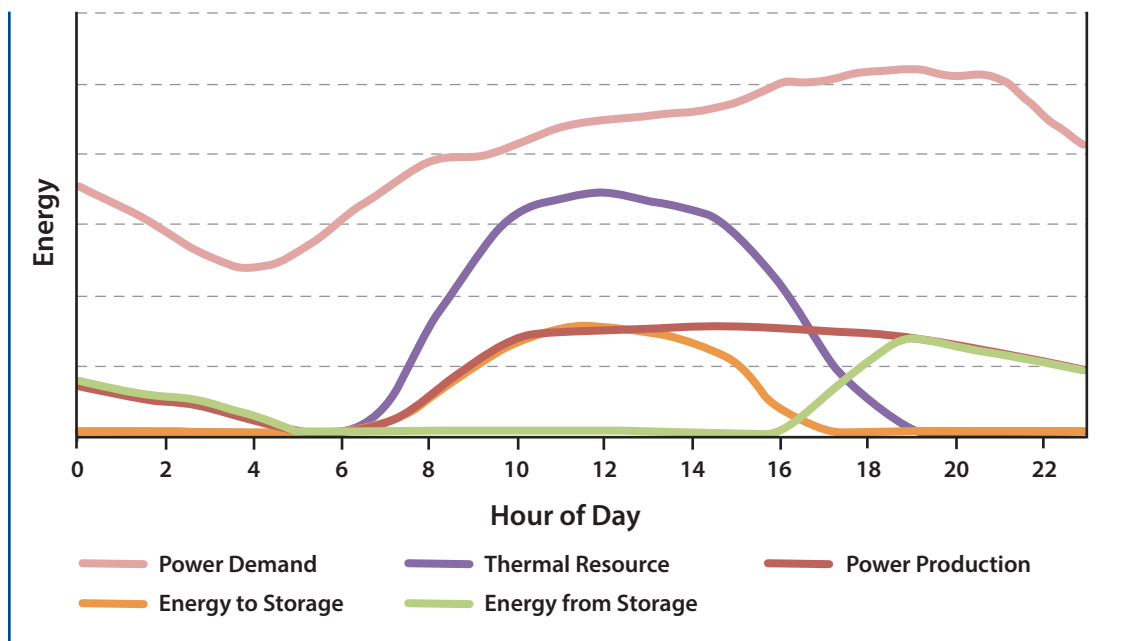

^{ix}The figure assumes six hours of storage and shows how this amount of storage enables the CSP plant to shift and lengthen power production for a better match with electricity demand. The number of hours of storage is a way of describing the size of the storage system and refers to the amount of thermal energy needed to run the steam turbine for that period of time at its full capacity.

Of course, adding thermal energy storage to a CSP plant is not free. Additional capital and operating costs are incurred above and beyond those that would accompany a facility without storage. As a result, decisions about whether to add storage to a CSP system and, if so, how to size the storage system to be added become questions of techno-economic optimization. What amount of storage, if any, will yield the greatest return on investment given the additional costs and market conditions for sales of power generated from the CSP system? Figure 3.10 shows a set of scenarios illustrating how the LCOE for one particular CSP tower plant changes in relation to different levels of storage capacity and the solar multiple^x of the mirror field.

Adding thermal storage to a solar tower plant provides a greater benefit than adding storage to a trough plant because solar tower plants are capable of operating at higher temperatures. This means a smaller amount of TES fluid is needed to store the same amount of thermal energy.

FINDING

CSP lends itself readily to highly efficient thermal storage. Storage reduces the levelized cost of electricity and allows for increased utilization (higher capacity factor) for both trough and solar tower designs, with a greater impact on towers. Importantly, thermal energy storage makes CSP electricity dispatchable.

Figure 3.10 Effect of Solar Multiple and Storage Size on LCOE of a CSP Tower Plant

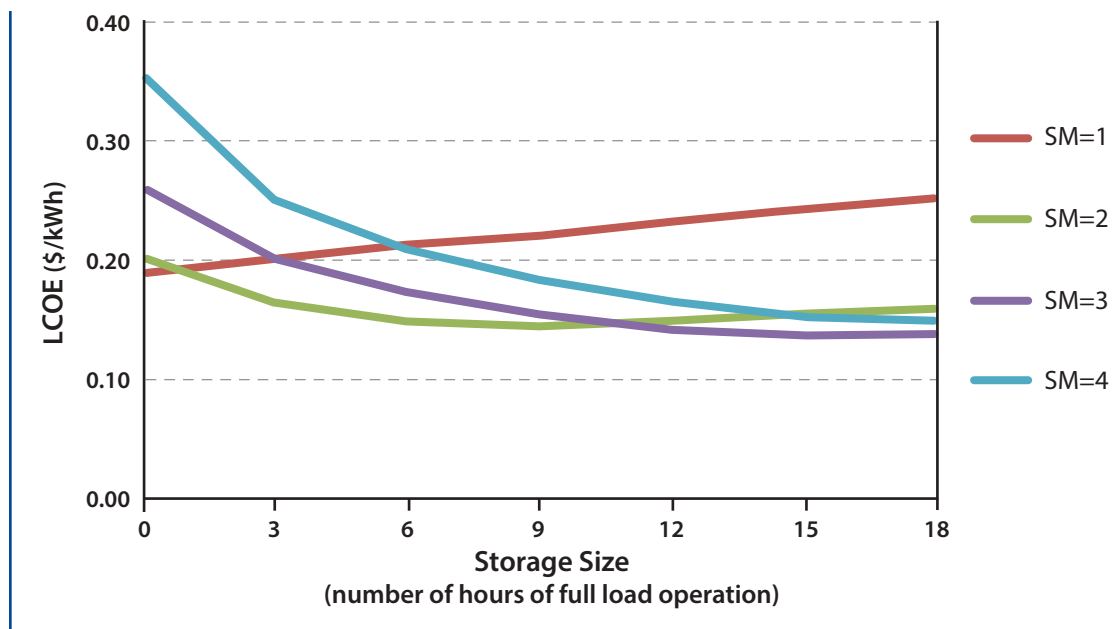

^xThe solar multiple is used to express the size of the solar field in terms of the nameplate capacity of the plant. For a solar multiple of 1, the mirror field supplies sufficient thermal energy to the power cycle to drive it at its nameplate capacity under design conditions. Plants with thermal storage systems require solar multiples greater than 1 to be able to provide heat to both the power block and the storage system when the solar resource is available.

3.4. COMPARISON OF VARIOUS CSP TECHNOLOGIES

A variety of metrics can be used to compare different solar power technologies, including scalability, capital and operating costs, dispatchability, etc., but the main criterion is the cost (value) of electricity produced, especially for utility-scale deployment. Among different CSP technologies, only dish Stirling engine designs are not suitable for large-scale deployment due to the high cost of Stirling engines at this time.

Table 3.2 summarizes and compares salient aspects of the major CSP technologies discussed in this chapter. Although CSP technologies have higher capital costs than PV technologies per unit of generation capacity, at suitable locations such as in the southwestern United States they can compete with PV because of their higher capacity factor when

a thermal storage system is added to the plant design (see Chapter 5 for more details). Also, CSP systems have higher O&M costs than PV systems, but if they are implemented with thermal storage they can produce dispatchable power, which can be sold at higher prices.

Table 3.3 shows technical parameters and cost figures for three utility-scale solar power plants that recently started operating in the United States. A PV system is included for purposes of comparison with the two CSP systems shown. The figures in the table are illustrative of trough, solar tower, and PV technologies. Note that the Solana plant is the only plant that includes thermal energy storage. Although adding thermal storage increases the capital cost of this plant, it improves the plant's economics by increasing its capacity factor to more than 40% (compared with capacity factors on the order of 30% or less for a typical solar plant).

Table 3.2 Advantages and Disadvantages of Various CSP Technologies

Focal Geometry	Line-Focus Technologies		Point-Focus Technologies		
Design	Parabolic Trough	Linear Fresnel	Solar Tower	Beam-Down	Dish-Stirling Engine
Technology Maturity	Most mature	Few installations	Commercial deployments	Early development	Proposed installations
Preferred Scale	Large	Large	Large	Large	Small
Capital Cost (Relative)	Moderate	Low	High	Moderate to high; low storage costs	High (low per unit)
Operating Cost (Relative)	High	Low	High	Similar to solar tower	High (one engine per dish)
Annual Solar-to-Net Electricity Conversion Efficiency^a	~15% ^b	~11% ^b	~17% ^b	~15%–19% ^{13,c}	~22% ^b
Thermal Storage	Feasible	Feasible	Feasible and more efficient due to higher temperature	Feasible; very little energy lost	Not currently possible
Characteristics	<ul style="list-style-type: none"> • Significant construction and operational experience • High radiative and convective energy losses 	<ul style="list-style-type: none"> • Low cost due to fewer moving parts and no tracking • Lower efficiency 	<ul style="list-style-type: none"> • High cost due to expensive heliostat field • High-temperature HTF possible • High efficiency 	<ul style="list-style-type: none"> • Lower efficiency than best solar tower due to added mirrors • Lower storage cost (ground storage) 	<ul style="list-style-type: none"> • High engine efficiency • High cost due to expensive engines (one for each dish)

Notes:

^aThe efficiency figures are indicative values. Many factors affect the efficiency of CSP plants, such as plant size and location, technologies selected for plant components, efficiency of the heat-to-electricity system, etc.

^bThe calculated efficiencies are obtained from SAM simulations (except for the beam-down entry). All simulated cases are assumed to be located in Daggett, California and have 150 MW_e net capacity.

^cWe do not have detailed information on the beam-down technology reported in Ref. 13. As a result, the reported efficiency may not be on the same basis as the other technologies.

Table 3.3 Recent Utility-Scale Solar Power Plants Commissioned in the United States¹⁴

Project	Abengoa Solar Solana Project	Ivanpah Solar Electric Generation System	California Valley Solar Ranch
Owner	Abengoa (based in Spain)	BrightSource Energy, NRG Energy, Google, Bechtel	NRG Energy and SunPower
Location	Gila Bend, AZ	Mojave Desert, CA	San Luis Obispo, CA
Operation Start	2013	2013 (first tower)	2013
Technology Design	CSP – Parabolic Trough 32,700 collectors with 28 mirrors each	CSP – Solar Tower 300,000 mirrors and 3 towers Air-cooled	PV 88,000 tracking panels
Capacity	280 MW	392 MW	250 MW
Storage	Yes (6 hrs, molten salt)	No	No
Capacity Factor	~41%	~31%	~25%
Capital Cost (\$/kW capacity)	\$2.0B (7,100)	\$2.2B (5,600)	\$1.6B (6,400)
Estimated Operating and Maintenance Cost^{xi}	~3 cents/kWh	~3 cents/kWh	<1 cent/kWh
Fossil-Fuel Backup	Natural gas	Natural gas	—
Plant Footprint	3 mi ² (including storage)	6.2 mi ²	3 mi ²
Power Purchase Agreement	Arizona Public Service (30-yr at \$0.14/kWh)	PG&E and Southern California Edison (25-yr thought to be >\$0.135/kWh)	PG&E (25-yr)

^{xi}Operating costs are estimated using data from the literature as well as results from the System Advisor Model (SAM).⁵

3.5 HYBRID CSP SYSTEMS

CSP plants convert solar radiation to heat before using the heat to generate electricity. This makes it possible to pair a CSP plant in a hybrid configuration with another plant that either generates or consumes large quantities of heat. Furthermore, the power cycle used in CSP systems is similar to that used by traditional power generation facilities, such as coal or natural gas plants. As a result it is possible to integrate the two types of plants in a solar–fossil hybrid system.

Although adding natural gas generation to a CSP system does not, strictly speaking, amount to adding storage, hybrid solar–gas systems can provide backup power when the sun is not shining while also enabling more efficient plant utilization, thus lowering costs per kWh. The current abundance of low-cost natural gas in the United States makes this an attractive option. The simplest form of hybrid design is illustrated in Figure 3.8, which shows an additional backup boiler that can be fired by fossil fuel — generally natural gas — when steam is needed that cannot be generated from the solar field. The incremental costs for this approach, including the additional boiler and fuel, are relatively modest; such gas-fired backup systems have been used in eight of the nine SEGS plants currently in operation.

Alternatively, a solar thermal plant can “piggy back” on a baseload fossil-fuel-fired power plant.¹⁵ In this configuration, power is produced from the gas turbine (fossil fuel only) as well as from the steam turbine, which uses steam generated from the lower temperature heat sources (fossil plus solar). The boiler must be oversized relative to the fossil-only plant to accommodate the steam produced by the solar

field. The scale of the oversizing is determined by a techno-economic optimization since the use of a larger boiler leads to higher capital cost compared with a fossil-fuel-only plant. A specific form of this type of hybridization is the integrated solar combined cycle system (ISCCS), which combines solar with a natural gas combined cycle power plant. A process flow diagram for an ISCCS is shown in Figure 3.11. The first operational ISCCS plant is in Yazd, Iran; this 17-MW plant began operation in 2009. In 2010, Florida Power and Light began operating a 75-MW hybrid CSP add-on to an existing natural gas combined cycle power plant in Martin County, Florida.¹⁶

FINDING

CSP technologies can be hybridized with traditional fossil energy power plants because they can share a common turbine generation device. This provides a potentially smooth migration path from fossil energy to solar energy, at least in certain geographic regions.

The other option for hybridization is to use the thermal energy from CSP plants as process heat for integrated applications. Hybridization of CSP plants with thermal desalination facilities is a good example of this approach.¹⁷ This hybridization scheme may be especially interesting given the good overlap between regions of the world with abundant direct solar irradiance and water stress. In such hybridizations, the low-temperature heat from the turbine can be used for evaporating water in the desalination process.^{18,19,20,21} This also helps reduce the size of the condenser system (either wet or dry) needed for the CSP plant.

Figure 3.11 Integrated Solar Combined Cycle System

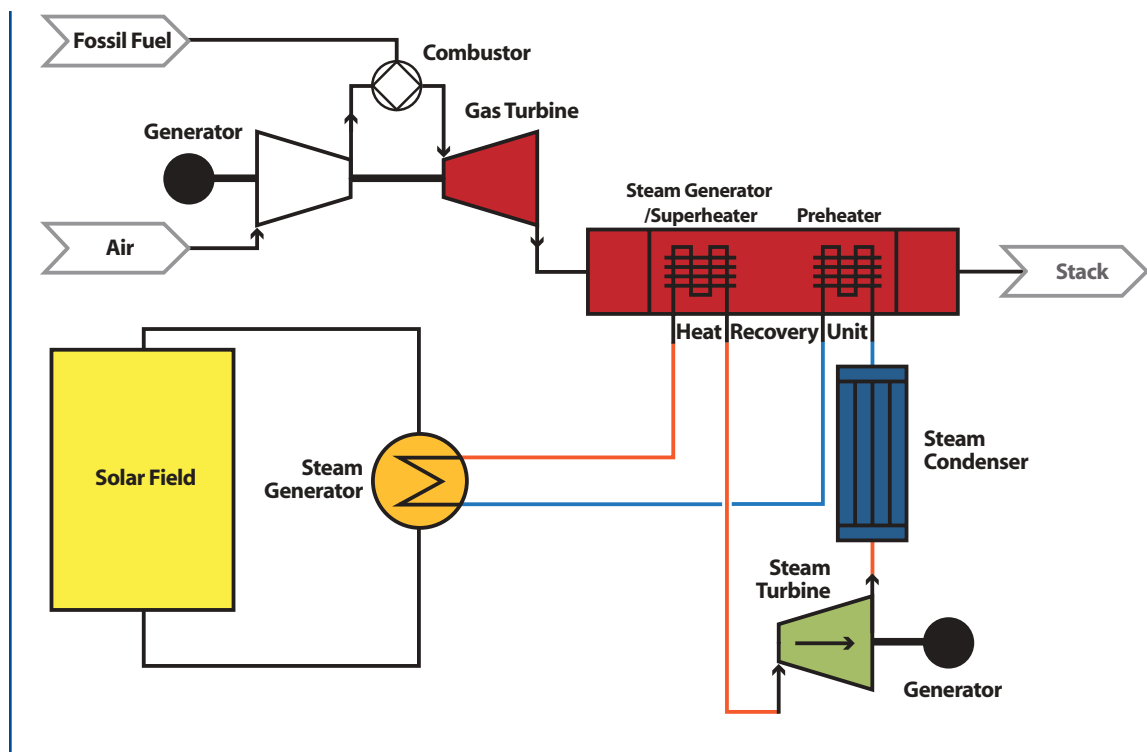

3.6 CSP TECHNOLOGY TRENDS

Future R&D on line-focus and point-focus CSP technologies will aim to reduce costs and increase conversion efficiency, although point-focus technologies are expected to emerge as the technologies of choice due to their ability to achieve higher efficiencies and lower costs compared to line-focus designs. One area of immediate attention for both trough and tower technologies is the development of more efficient and cost-effective collection systems. The use of advanced materials is expected to enable improvements, leading to collection systems that not only have better reflection or absorption characteristics, but that are also robust at higher temperatures and have lower cost.

FINDING

Parabolic trough is a proven CSP technology and solar tower installations are beginning to be deployed at significant scale. Improvements that lead to higher-temperature working fluids may allow increased efficiencies in towers and increase the long-run cost advantages of this technology over parabolic trough technology.

One area of immediate attention for both trough and tower technologies is the development of more efficient and cost-effective collection systems.

In addition, other novel system designs are being investigated and developed that can offer significant improvements in CSP performance in the longer term. For example, in one variation of central receiver designs, called the direct solar-to-salt design, the receiver is replaced by a tank containing molten salt (Figure 3.12). Because solar energy is absorbed through several meters of penetration in the salt bath, materials design issues for the receiver surface are avoided. This type of system has two major advantages: simple integration with storage and operation at much higher temperatures than are possible with traditional receivers. Another advantage of the direct solar-to-salt design is that it does not require flat terrain and therefore has the potential to be less costly than conventional CSP technologies and less likely

The other focus area for CSP research, and one that is also relevant for the further enhancement of other, conventional thermal electricity generation technologies, is the development of more efficient power cycles that can operate at higher temperatures. Here again, advances can be enabled by the use of new materials that can withstand the harsh environment of molten salt (in the case of CSP systems) at very high temperatures. Operating temperatures for Rankine cycle systems are also limited by the materials used to construct the steam turbine as well as by the thermodynamic properties of water, which is the most common working fluid.

A power cycle that deserves attention is the Brayton cycle. In the conventional Brayton cycle, which is used in gas turbines and jet engines, air is compressed, heated, and then expanded in a turbine. Generally, the Brayton cycle is capable of operating at much higher temperatures and therefore delivering higher efficiencies.²³ There are different variations of the Brayton cycle that can be utilized for or integrated with CSP plants. For example, Brayton cycles can utilize either air or supercritical carbon dioxide²⁴ (CO₂) as the working fluid.^{xii}

The other focus area for CSP research is the development of more efficient power cycles that can operate at higher temperatures.

to create siting conflicts with agricultural and ecologically sensitive lands. Much research needs to be done on direct solar-to-salt configurations like the one shown in Figure 3.12 — including research on salt composition, aperture design, hot/cold salt separator, etc.

Figure 3.12 Direct Solar-to-Salt Design

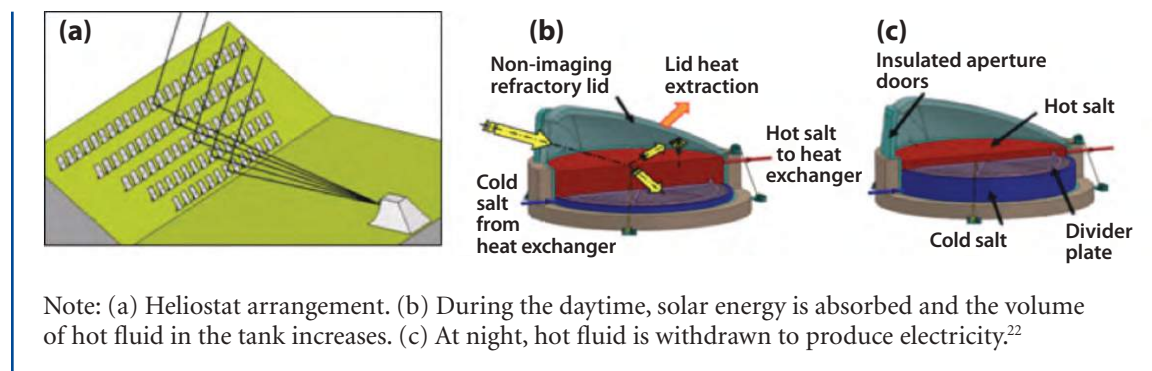

^{xii} Conventional Brayton cycle systems, where air is used as the working fluid, are open systems, meaning the exhaust gas is not recycled back. Systems that use the supercritical CO₂ Brayton cycle are usually closed, meaning that the CO₂ is recycled back to the beginning of the cycle.

An air Brayton cycle is of interest because it is more efficient than current power cycles, does not use water, and can be directly combined with natural gas combustion. An example of a possible air Brayton cycle is shown in Figure 3.13. Here, high temperature molten salt (at 700°C), which could be provided by, for example, a direct solar-to-salt design (described above), drives a combined open-air Brayton cycle with natural gas peaking capability. Since 700°C is above the auto-ignition temperature of natural gas, natural gas could be injected directly into the last stage of the turbine. This would allow variable power output from the system. In addition, natural gas can provide backup in this hybrid system. A hybrid solar–gas turbine system was demonstrated in 2002.²⁵

A supercritical CO₂ Brayton cycle is of particular interest because of its higher efficiency (near 60%) and smaller volume relative to current

Rankine cycles. This is due to the fact that CO₂ at supercritical conditions (approximately 31°C and 70 atmospheres) is almost twice as dense as steam, which allows for the use of smaller

A supercritical CO₂ Brayton cycle is of particular interest because of its higher efficiency (near 60%) and smaller volume relative to current Rankine cycles.

generators with higher power densities. The other advantage of a supercritical CO₂ Brayton cycle is that it can be utilized in directly heated power cycles, in which a fuel such as natural gas is burned in a mixture of CO₂ and oxygen. The combustion process increases the temperature of the working fluid (in this case CO₂) while producing only water and additional CO₂. The produced water is separated and removed, and the CO₂ from combustion is also removed from the cycle.

Figure 3.13 Combined Open-Air Brayton Cycle with Natural Gas Peaking Capability²³

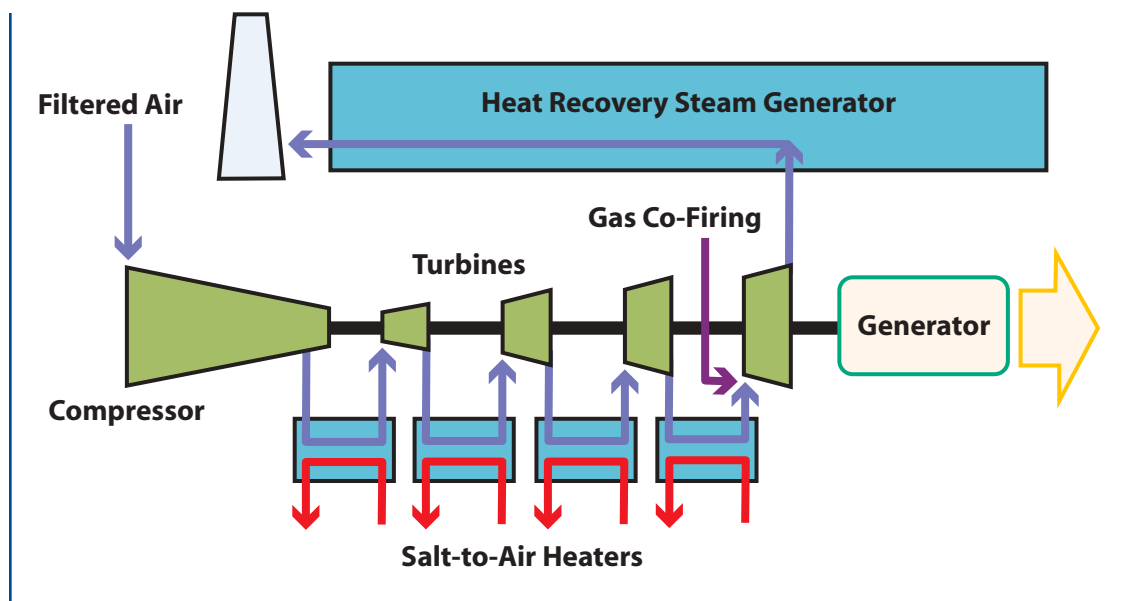

Other variations of the Brayton cycle may yield even higher efficiencies. An example is a Brayton cycle with recompression, which is being investigated by Sandia National Laboratories among others.²⁶

With respect to thermal energy storage technologies, research is now underway on a single-tank thermocline^{xiii} configuration that reduces costs by storing the hot and cold fluids in a single tank. In addition to lower cost, this configuration offers the potential advantage of replacing expensive thermal energy storage fluids with low-cost, high-heat-capacity filler materials such as sand. It is not yet clear whether thermocline systems will be limited to small CSP plants in the 50 kW to 20 MW range. By contrast, two-tank indirect and direct systems should be viable up to 250 MW.

CSP is not currently cost-competitive without regulatory mandates or government assistance.

Phase change materials^{xiv} offer the advantage of greatly reducing the volume of thermal storage systems for any of the CSP configurations. However, this concept is still in the research stage.

A variety of thermochemical TES systems are also being explored. The furthest along is ammonia storage, in which incident solar radiation is used to drive the dissociation of ammonia. The resulting hydrogen and nitrogen can subsequently be synthesized to re-form ammonia, and the heat from this exothermic reaction can be used to produce steam for power generation.

Thermal energy storage is not practical for dish CSP systems, apart (perhaps) from storage concepts that exploit phase change materials and thermochemical reactions.

3.7 CONCLUSIONS

CSP is a technologically viable solar power option in locations with suitable solar resources such as the southwestern United States. However, CSP is not currently cost-competitive without regulatory mandates or government assistance.

Parabolic trough technologies are proven and have realized cost reductions from operational experience; this design dominates current CSP installations. Solar tower technology is beginning to be deployed at significant scale but will face a period of “learning-by-doing” before it becomes widely deployable. The prospect of achieving higher-temperature working fluids in tower systems may allow increased efficiencies and long-run cost advantages over parabolic trough technology. However, the precise trajectory of cost reductions that might be achieved in the future is uncertain and estimates vary widely across studies.

CSP lends itself readily to highly efficient thermal energy storage. Storage in turn reduces the LCOE for these systems and increases their capacity factor. This is true of both trough and tower configurations, but the impact is greater in tower systems. Importantly, the addition of storage makes CSP electricity dispatchable.

^{xiii}In thermocline storage systems, where hot and cold fluids are stored in the same tank, stable separation is achieved by large buoyancy forces associated with the density difference between the hot and cold layers.

^{xiv}Phase change materials offer a potential approach to storing thermal energy because they can be made to change phase (e.g., solid to liquid) by absorbing heat and then will release heat when transformed back to their initial phase, at desired temperatures and pressures.

Finally, CSP can be hybridized with traditional fossil energy power plants because of the opportunity to use a common turbine generation device. This provides a potentially smooth migration path from fossil energy to solar energy, at least in certain geographic regions.

Given CSP's dependence on direct sunlight, the best CSP resources in the United States are concentrated in the desert Southwest. This means that the availability of high-voltage transmission connections to these areas needs to be considered in CSP development.

CSP hybridized with traditional fossil energy power plants provides a potentially smooth migration path from fossil energy to solar energy, at least in certain geographic regions.

REFERENCES

- ¹U.S. Department of Energy, Report to Congress, *Concentrating Solar Power Commercial Application Study: Reducing Water Consumption of Concentrating Solar Power Electricity Generation*. (2009): 4. https://www1.eere.energy.gov/solar/pdfs/csp_water_study.pdf
- ²Mehos, M. S., and D.W. Kearney. "Potential Carbon Emissions Reductions from Concentrated Solar Power by 2030." *Tackling Climate Change in the U.S.: Potential Carbon Emissions Reductions from Energy Efficiency and Renewable Energy by 2030*. American Solar Energy Society. (2007): 79-89.
- ³U.S. DOE, *2010 Solar Technologies Market Report*. (November 2011): 54. <http://www.nrel.gov/docs/fy12osti/51847.pdf>
- ⁴NREL, Concentrating Solar Power Resource Maps. Southwestern U.S. Maps. 1% Slope. http://www.nrel.gov/csp/images/1pct_csp_sw.jpg
- ⁵NREL System Advisor Model (SAM) Version 2014.1.14. <https://www.nrel.gov/analysis/sam/>
- ⁶IVANPAH Solar Electric Generation System. <http://ivanpah.nrgenergy.com/>
- ⁷Mokhtar M. B., *The Beam-Down Solar Thermal Concentrator: Experimental Characterization and Modeling*, Masdar Institute of Science and Technology (2011), <http://web.mit.edu/parmstr/Public/aaReprints/Theses/Mokhtar%202011.pdf>
- ⁸Brost, R. "Design of a High-Temperature Molten Salt Linear Fresnel Collector," *2010 Solar Program Peer Review Report: An Independent Evaluation for Program Activities for FY2009 and FY2010*. Presentation No. CSP005. (2010) A4-283. http://www1.eere.energy.gov/solar/review_meeting/pdfs/prm2010_exec_summary.pdf
- ⁹"The Inside Scoop on Solar Technology." *Areva Next Energy Blog*. (November 23, 2010). <http://us.arevablog.com/2010/11/23/the-inside-scoop-on-solar-technology/>
- ¹⁰Pletka, R. et al. *Arizona Renewable Energy Assessment*, Final Report. Project Number 145888. Black & Veatch Corporation, Overland Park, Kansas. (September 21, 2007): 4-35. http://www.energy.ca.gov/reti/documents/2007-09_AZ_Renewable_Energy_Assessment.pdf
- ¹¹Mills, D. (2004). "Advances in solar thermal electricity technology." *Solar Energy* 76 (1-3): 19-31.
- ¹²Crescent Dunes Solar Energy Project. Concentrating Solar Power Projects. National Renewable Energy Laboratory. http://www.nrel.gov/csp/solarpaces/project_detail.cfm/projectID=60
- ¹³Kanellos, M. *Another Way to do Solar Thermal?*, GreenTechMedia, <http://www.greentechmedia.com/articles/read/another-way-to-do-solar-thermal>
- ¹⁴Johnson J. "A New Race for Solar," *Chemical and Engineering News*, Volume 91, Issue 50, (December 16, 2013): 9-12. <http://cen.acs.org/articles/91/i50/New-Race-Solar.html>
- ¹⁵*Assessment of Parabolic Trough and Power Tower Solar Technology Cost and Performance Forecasts*, NREL Report No. SR-550-34440. Sargent & Lundy LLC Subcontractor, Golden, CO. (October 2003). <http://www.nrel.gov/csp/pdfs/34440.pdf>
- ¹⁶*FPL Unveils World's First Hybrid Solar Energy Center*. Florida Power and Light. (March 5, 2011). <http://www.prnewswire.com/news-releases/fpl-unveils-worlds-first-hybrid-solar-energy-center-117460008.html>
- ¹⁷Zak, G. M., et al. "A Review of Hybrid Desalination Systems for Co-production of Power and Water: Analyses, Methods, and Considerations." *Desalination and Water Treatment* Volume 51, Issue 28-30 (2013): 5381-5401. <http://www.tandfonline.com/doi/pdf/10.1080/19443994.2013.769697>
- ¹⁸Palenzuela, P. "Thermodynamic Characterization of Combined Parabolic-trough Solar Power and Desalination Plants in Port Safaga (Egypt)." *SolarPaces Conference*. (2011).
- ¹⁹Casimiro S. et. al. "MED Parallel System Powered by Concentrating Solar Power (CSP). Model and Case Study: Trapani, Sicily." *Desalination and Water Treatment*. (2014): 1-14. <http://www.tandfonline.com/doi/pdf/10.1080/19443994.2014.940222>
- ²⁰*AQUA-CSP Concentrating Solar Power for Seawater Desalination*. Institut fur Technische Thermodynamik. <http://www.dlr.de/tt/aqua-csp>
- ²¹Trieb F. "Concentrating Solar Power for Seawater Desalination – AQUA-CSP" *The 3rd International Conference on Water Resources and Arid Environments and the 1st Arab Water Forum*. (2008). <http://www.icwrae-ppspw.org/images/stories/2008/Water/20.pdf>
- ²²Slocum, A. H. et al. "Concentrated solar power on demand." *Solar Energy* 85, no. 7 (2011): 1519-1529. <http://www.sciencedirect.com/science/article/pii/S0038092X11001307>

- ²³Forsberg, C. “Fluoride-Salt-Cooled High-Temperature Reactors for Power and Process Heat,” *2012 World Nuclear University Institute*, Christ Church, Oxford, England (July 10, 2012). http://www.jaif.or.jp/ja/wnu_si_intro/document/2012/1.2-3%20Forsberg,%20Charles_Fluoride-Salt-Cooled%20HTGRs%20for%20Power%20and%20Process%20Heat.pdf
- ²⁴Ma Z., Turchi C., *Advanced Supercritical Carbon Dioxide Power Cycle Configurations for Use in Concentrating Solar Power Systems*, Supercritical CO₂ Power Cycle Symposium, Boulder, Colorado, (May 24-25, 2011).
- ²⁵European Commission, EUR 21615 — SOLGATE - Solar hybrid gas turbine electric power system, Luxembourg: Office for Official Publications of the European Communities, (2005): 47.
- ²⁶Sandia National Laboratories, *Nuclear Energy Systems Laboratory (NESL) / Brayton Lab*, <http://energy.sandia.gov/energy/nuclear-energy/advanced-nuclear-energy/nuclear-technology-users-facility-ntuf/>

The hyperlinks in this document were active as of April 2015.



Section III – Business/Economics

INTRODUCTION

This section explores the costs, subsidies, and market conditions that determine the current competitive position of solar generation, considering the different solar technologies that are currently available as well as fossil-fuel generation alternatives. We also explore the potential for future improvement in solar energy's competitive position. Installed photovoltaic (PV) capacity grew at a very rapid rate in the United States over the past half-dozen years, and the deployment of concentrated solar (thermal) plants (CSP) progressed over this period as well, though at a slower pace. The solar business is evolving in response to this rapid growth, so our description of the industry's structure and performance is at best a fuzzy snapshot of a moving target. We approach the task in two steps. Chapter 4 explores the per-watt cost and price of PV generation. Chapter 5 then considers the per-kilowatt-hour (per-kWh) cost of electricity produced by PV and CSP systems under alternative subsidy and regulatory regimes and in different areas of the country.

PV installations come in a wide range of sizes, so Chapter 4 brackets its analysis of PV costs with a focus on large, utility-scale projects and small-scale residential units. Rapid growth in the U.S. PV market has been aided by government subsidies and by falling prices of modules and other specialty hardware. In addition, growth in the residential sector has been spurred by the introduction of a third-party ownership model in which the homeowner pays only for the future output of the PV system and avoids the large up-front cost of buying the system. There has been much less progress in reducing so-called balance-of-system (BOS) costs, which include the costs of installation labor, permitting, inspection and associated fees, customer acquisition (marketing), financing, taxes, and various business margins. The influence of BOS costs is greatest in the residential sector, leading to an average cost per installed watt for rooftop PV systems that is much greater than the per-watt cost of utility-scale PV installations.

Comparing the average cost of installed PV systems with reported average prices for these systems reveals a rough correspondence between cost and price in utility-scale installations but not in residential installations, where prices are substantially above estimates of installed cost. Investigating the way federal subsidies can be calculated in some business models shows how this price–cost disparity can arise under less than fully competitive conditions, effectively inflating the federal subsidy per watt. We project that growing market scale and increased competition will put downward pressure on both installed prices and underlying costs, and we cite the German experience as a stretch target for reducing costs in the residential sector.

Our analysis of the economics of CSP generation draws from Chapter 3 and other sources in the literature. We consider several configurations of mirrors and collectors, described in Chapter 3, as well as a solar tower technology, with different assumptions concerning hours of thermal energy storage included in the CSP plant design. Chapter 5 then applies per-watt cost estimates from Chapters 3 and 4 — together with assumptions about other economic inputs, such as the cost

of capital — to calculate the levelized cost of electricity (LCOE). The per-kWh LCOE for different solar energy technologies can then be compared with the LCOE for fossil generation options. We address several issues in the effort to construct a valid comparison:

- Solar insolation differs by location; to explore this influence we study facilities located in California and Massachusetts.
- All kWh from PV generation do not have equal value. A more informative LCOE calculation adjusts for the marginal price of electricity displaced during the hours of PV output.
- Utility-scale projects sell into wholesale markets whereas residential solar units compete within a distribution system, where their economics depend on the price regime applied by the distribution utility.
- Existing federal subsidies may influence solar economics differently depending on their (poorly understood) effectiveness — for example, the cost of accessing financial markets where the value of current tax subsidies can be monetized.

Chapter 5 summarizes our estimates of LCOE for different solar technologies in different market segments and locations and tests the sensitivity of our results to these and other influences.

Several summary conclusions flow from the analysis: location matters, the per-kWh cost of electricity generated by residential PV is much higher than that from utility-scale plants, and the economics of residential solar increasingly depend on controlling BOS components. A tax on carbon dioxide emissions from fossil generation would be an effective aid to solar, but that influence is lacking in the absence of a comprehensive national policy for addressing climate change. Except under certain special market conditions — such as apply to utility-scale PV in sunny states like California and in other states with renewable performance standards, or to residential units under net metering regimes in areas with high retail electricity prices — the solar energy technologies available today are more expensive than fossil-fuel generation alternatives, even with existing federal subsidies.

Chapter 4 – Solar PV Installations

Grid-connected PV is growing at a rapid rate in the United States, driven by a host of federal, state, and local incentives and facilitated by falling prices of solar modules and inverters. The PV market is highly diverse — installations range in size from small rooftop residential units to very large utility-scale plants — and PV developers are applying an evolving set of business models in various market segments and subsidy environments. Other factors influence the economics of PV electricity (see Chapter 5), with a key one being the installed price per peak watt ($\$/W_p$), which includes the cost of the PV module as well as so-called balance-of-system (BOS) costs. BOS costs include the cost of the inverter and other hardware, along with all other expenses involved in customer acquisition, physical installation, regulatory compliance, and grid connection. In less-than-competitive markets BOS costs will also include rents taken at various points in the supply chain. In some PV market segments, BOS costs dominate the installed price per watt.

After briefly summarizing the rapidly changing PV sector, this chapter explores the engineering costs, financial subsidies and associated business models, and competitive conditions that lead to reported PV prices in current U.S. applications. Given that the future of PV technology will be strongly influenced by the PV industry’s ability to sustain recent price declines, this chapter also explores ways to speed the advance of this technology and make better use of the subsidy dollars devoted to it.

4.1 THE CHANGING LANDSCAPE FOR PV DEPLOYMENT IN THE UNITED STATES

Rapid Capacity Growth

In the last half-dozen years, installed PV generation capacity in the United States has grown at a very high rate, with approximately 18 gigawatts (GW) of grid-connected PV added between the beginning of 2008 and the end of 2014.^{1,2} California has been in the vanguard of this rapid deployment (Figure 4.1), accounting

Figure 4.1 Cumulative Grid-Connected PV Capacity by State^{1,2}

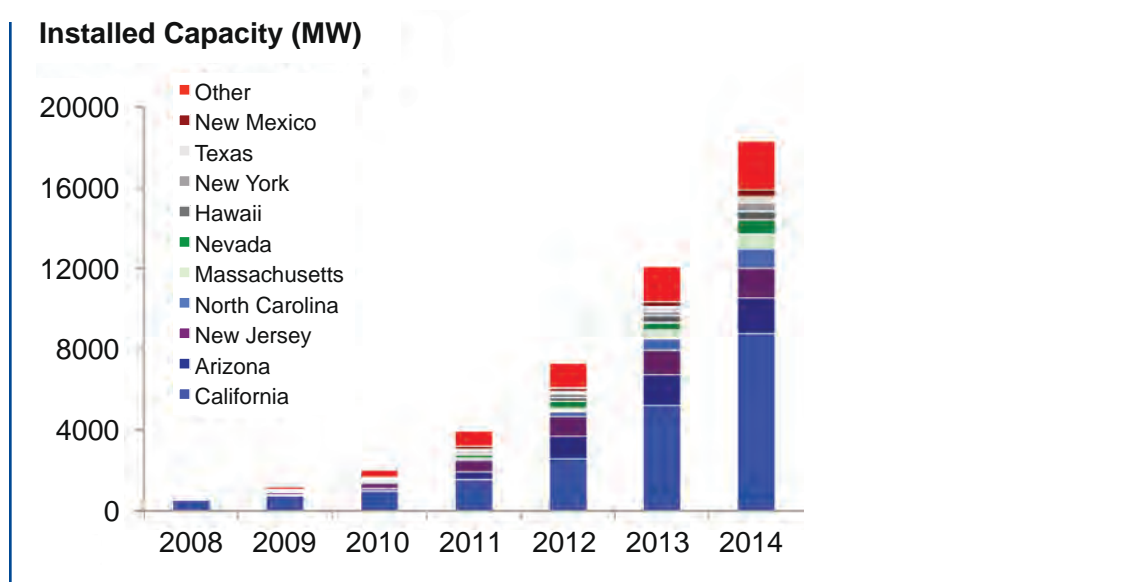

for nearly half (48%) of all PV capacity installed nationwide as of the end of 2014.^{1,2} With the exception of New Jersey and, to a lesser extent, Massachusetts and North Carolina, where factors including local utility rates and robust state-level mandates have spurred capacity additions, PV deployment has been concentrated in sunny southwestern and western states.

The systems included in these national- and state-level deployment figures range from modest residential rooftop units to utility-scale PV power stations, with commercial installations spanning the range in between. Because of this diversity, PV installations are usefully divided into three market segments based on their generating capacity:

Residential: Systems up to 10 kilowatts (kW)

Commercial: Systems ranging between 10 kW and 1 megawatt (MW)

Utility: Systems larger than 1 MW

Municipal systems usually fall into the commercial category. Unavoidably, there is overlap in the size of some residential and small commercial installations, and between large commercial PV and utility-scale plants.

Figure 4.2 shows the breakdown of PV installations in each of these categories from 2008 through 2014.^{1,2} Utility-scale facilities, defined here as systems with an installed capacity of at least 1 MW, are now responsible for just over half of all installed PV capacity in the United States, though they represent only a vanishingly small fraction of the total number of installations.^{1,2,3,4}

FINDING

As of 2014 only 0.3% of U.S. PV systems are 1 MW or larger, yet these utility-scale facilities account for 55% of the nation's total PV generation capacity.

Figure 4.2 Annual U.S. PV Installations by Market Segment^{1,2,3,4}

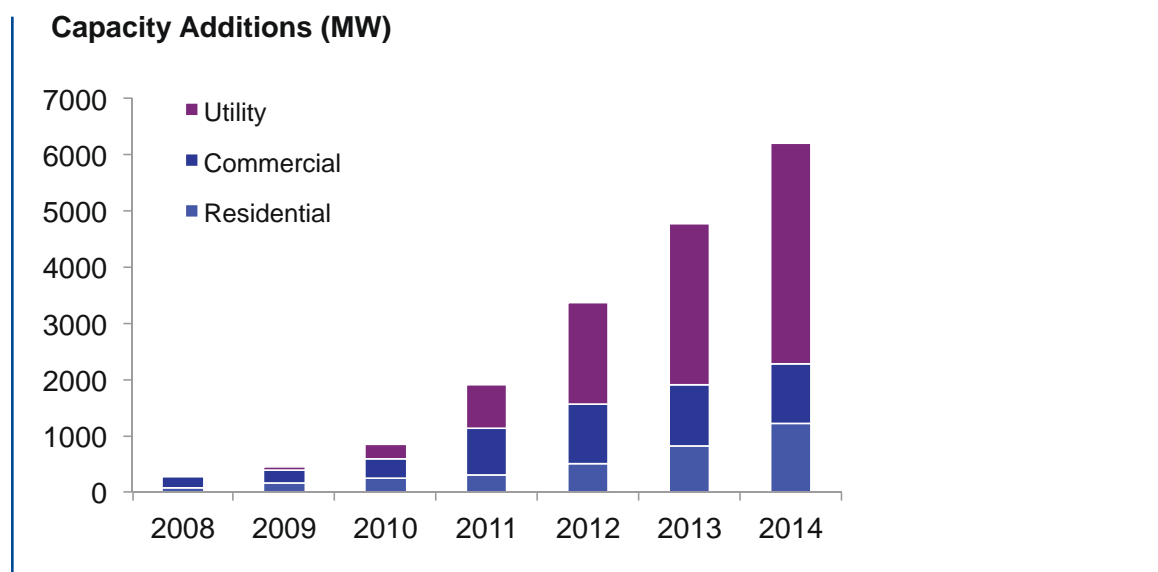

Falling Prices of Panels and Inverters

Owing to a combination of improved technology and manufacturing processes, and increased competition among suppliers, a decline in the cost of two key PV system components — the PV module and the power inverter — is contributing to rapid growth in U.S. PV deployment. In 2008, the average price for a module stood at around \$4.00 per peak watt (W_p). By the end of the second quarter of 2014, the average price had fallen a remarkable 84% to around \$0.65/ W_p (Figure 4.3). Similar though somewhat less dramatic reductions

A decline in the cost of two key PV system components — the PV module and the power inverter — is contributing to rapid growth in U.S. PV deployment.

have also been seen in the price of inverters. By mid-2014, the price for residential inverters in the United States was in the \$0.28/ W_p –\$0.31/ W_p range, approximately 50% below typical prices in 2009.^{5,6,7} The economic analysis discussed in Chapter 5 assumes an average price of \$0.29/ W_p for inverters.

Figure 4.3 Evolution of PV Module Prices in the United States from 2008 to 2014ⁱ

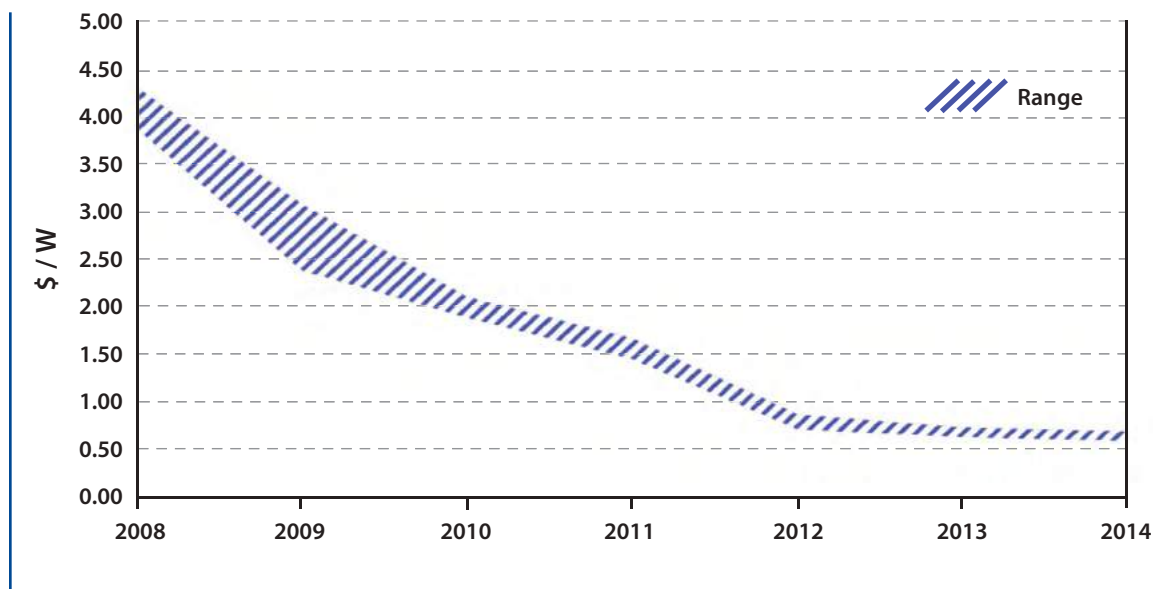

ⁱMIT analysis based on data from Solar Industry Association of America;^{1,2} Barbose, Weaver, and Darghouth;⁴ Photon Consulting LLC;⁶ Feldman, Margolis, and Boff;⁸ and other industry and public sources.

Although solar modules and other PV equipment are traded in markets with dependable reporting of transactions, there is uncertainty in the interpretation of these module price data. In recent years a majority of the solar panels installed in the United States were imported, mostly from China. Several Chinese suppliers have since gone bankrupt (or have been bailed out by regional authorities), as have several of their U.S.-based competitors. In addition, the United States and China are currently engaged in a dispute over trade practices at several stages in the supply chain.⁹ The most important dispute centers on anti-competitive pricing of Chinese modules and anti-dumping duties imposed by the U.S. government.¹⁰ This experience creates uncertainty as to whether U.S. module prices can be sustained in the short run, and about how future prices may be influenced by a potential resolution of the current U.S.–China trade controversy. The analysis conducted for this report therefore

assumes module prices commensurate with reported prices prior to the imposition of anti-dumping duties on imported modules.

Declining Reported PV System Prices

Only limited data are available to analyze the overall price of installed PV systems in the United States (see Box 4.1). The general trend is nonetheless clear: prices have fallen steadily in the U.S. context. Figure 4.4 shows reported average prices for residential and utility-scale solar installations. In both of these market segments, the average price per watt fell dramatically between 2008 and 2014. Residential prices declined by 50% and utility prices declined by more than 70%. Prices for commercial systems show a similar decline, with the absolute price per watt tending to lie 10%–15% below the residential average during this period. In dollar terms these reductions — for all categories of PV systems — amount to more than \$4.00/W_p.

Figure 4.4 Average U.S. Prices for Residential and Utility-Scale PV Systemsⁱⁱ

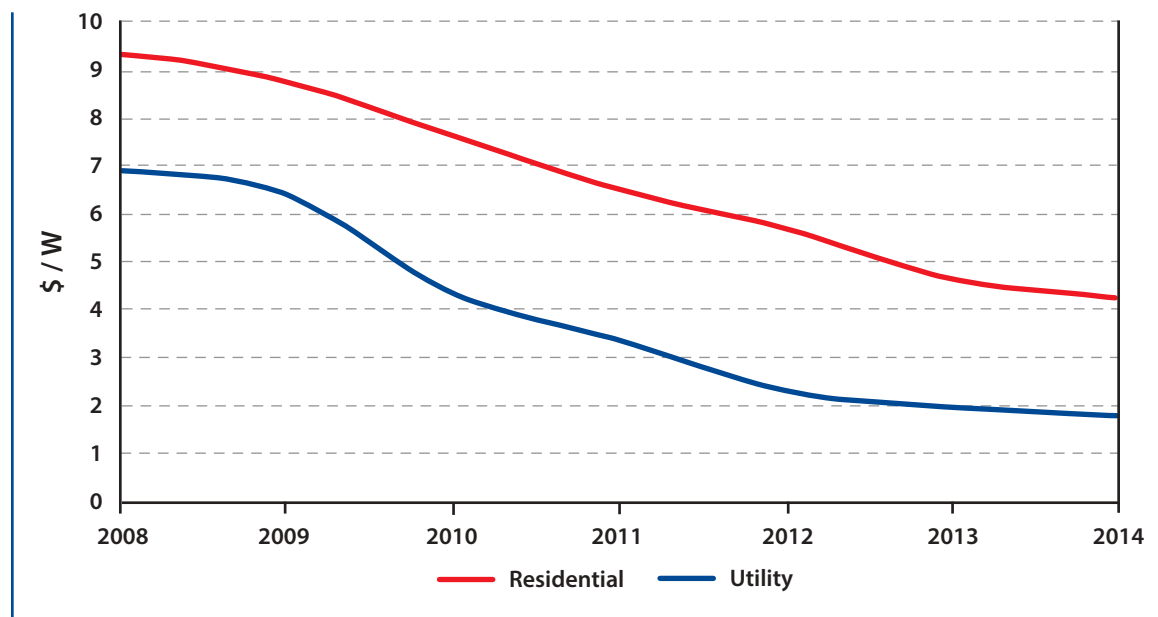

ⁱⁱMIT analysis based on data Solar Industry Association of America;^{1,2} NREL;³ Barbose, Weaver, and Darghouth;⁴ NREL;⁷ and Feldman, Margolis, and Boff.⁸

BOX 4.1 DATA ON INSTALLED PV PRICES

The recipient of a subsidy payment under the California Solar Initiative is obliged to report system location, size, developer name, form of sales agreement, and price.¹¹ For the United States as a whole the principal public data source on PV installations is Open PV, which is prepared by the U.S. Department of Energy's National Renewable Energy Laboratory (NREL).³ Open PV relies on self-reporting by a diverse set of agents and includes only system size, cost, and ZIP code. Figure 4.5 shows the distribution of reported prices for residential PV systems in California for 2010 and 2013.

Current data sources suffer from some limitations. Open PV has encountered problems with double counting and other quality control issues, though work is ongoing to improve its accuracy. In both the NREL and California databases, reported prices are not necessarily consistent across developers because system price can be estimated in one of several ways, as discussed elsewhere in this chapter. Also, definitions have changed over time, compromising year-to-year comparisons.

Figure 4.5 Histogram of Reported Residential PV Prices in California for 2010 and 2013¹¹

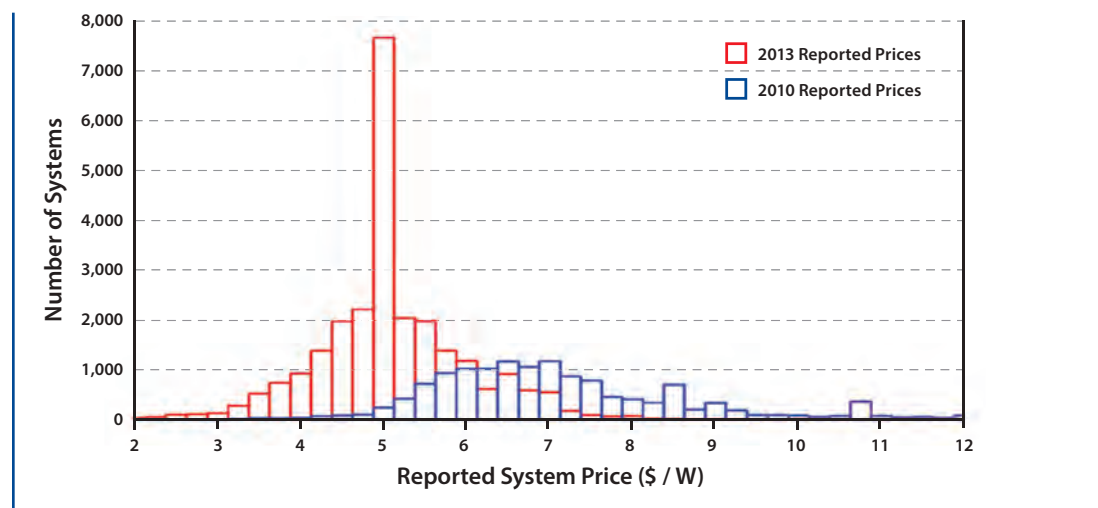

Importantly, much of the observed decline in PV system prices has been due to falling module prices. As a result, the relative role of BOS costs in overall system economics has grown more important in recent years.

This dynamic is illustrated in Figure 4.6, which shows the relative contribution of BOS costs to total prices for residential- and utility-scale PV systems in 2008, and again in 2014. In 2008, BOS costs accounted for a little more than half of a residential system's price and about 40% of the price of a utility system. By 2014, the relative

importance of BOS costs had grown to the point where these costs accounted for 85% of the price of a typical residential PV system and nearly 65% of the price of a utility-scale system.

FINDING

Prices for PV systems in the United States have fallen between 50% and 70% over the last half-dozen years. Almost all of this decline is attributable to falling prices for modules and inverters.

Figure 4.6 Relative Contribution of BOS Costs to Overall Prices for Residential and Utility-Scale PV Systems

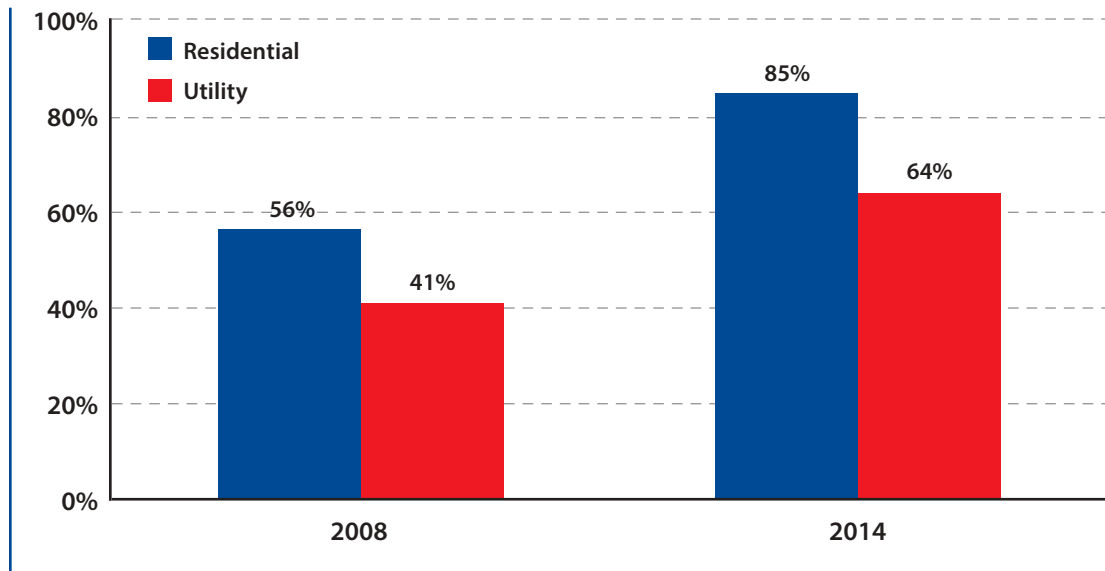

Reported prices — though they indicate progress in reducing PV costs — are not a sound basis for estimating the competitiveness of this technology in relation to other generation sources.

As discussed below, however, reported prices and estimates of the average cost of installed systems differ substantially in some sectors. For this reason, reported prices — though they indicate progress in reducing PV costs — are not a sound basis for estimating the competitiveness of this technology in relation to other generation sources.

Varying Policy Drivers

A number of federal, state, and local policies have been introduced to stimulate the development of renewable generation, including solar. These policies are discussed in more detail in Chapters 5 and 9. Renewable portfolio standards (RPS) are an important driver for

utility-scale installations in many areas; such standards currently exist in 29 states and the District of Columbia. RPS programs generally require electric utilities that sell at retail to generate electricity from renewable sources — or acquire renewable energy certificates from other generators — equal to a target percentage of total sales. RPS requirements differ across states, not only in the percent renewable contribution they specify but also in the way they treat different renewable technologies. In addition, target percentages may change over time. All solar generation is also supported by two federal investment subsidies: a 30% investment tax credit (ITC) and accelerated depreciation under the Modified Accelerated Depreciation System (MACRS), which allows solar assets to be depreciated, for tax purposes, over a five-year schedule. In addition, some state and local jurisdictions offer financial subsidies to solar investment, including property and sales tax abatement.

Federal subsidies have varied over the years and are scheduled to change in the near future. Absent new legislation, the ITC will fall to zero as a credit against the personal income tax at the end of 2016, influencing the net cost of PV systems that are purchased directly by homeowners. At the same time, the solar ITC will be reduced from 30% to 10% as a credit against the corporate income tax. This change will influence utility-scale and commercial PV installations as well as residential deployments where the PV systems are owned by a third party.

Evolving Business Models

Installers of PV systems have adopted different business models according to the market segment they serve, the mechanisms available to finance PV projects in different states, and the subsidies available. At utility scale, developers generally take a relatively simple approach: they respond to a request for proposals to build a system of a particular size or to deliver a specified quantity of solar-generated megawatt-hours (MWh) per year, or they approach utilities with their own proposed solar projects. Depending on contract details, the federal subsidy may be credited to the utility or taken by the developer and built into the developer's bid — in either case the subsidy serves to reduce the cost of PV generation to the electric utility.

The residential sector is richer in terms of the number of business models currently being employed to deliver PV systems for this market. Hundreds of small installers serve the residential market, selling PV units to individual households. In addition, a small number of large and small firms offer residential PV systems on a lease basis, where the solar unit is owned by a third party. In direct sales of residential installations, contract details and financial incentives to the customer may differ. Similarly, lease transactions offer choices

between the initial up-front expense to the homeowner and the price to be paid over time for the electricity generated by the PV system. Developers who offer lease arrangements also often deal in direct sales, and some firms offer bundled discounts for groups of customers in a city or small geographic area. Because they span a wide range of generating capacities, commercial PV systems are sold or leased under the full spectrum of business models and contract forms.

The solar industry's contribution to meeting future U.S. energy needs will be determined by a dynamic interaction between system costs; federal, state, and local regulations and subsidies; supplier business strategies; the intensity of competition between installers; and innovations in financing.

The installer industry is evolving rapidly. Where lease arrangements are allowed, they have been displacing direct sales, but to date only half of the states allow this business model, as others have yet to resolve regulatory conflicts with incumbent electric utilities. Also, the business model for PV firms focused on the residential sector is likely to change if federal subsidies are reduced as currently scheduled, and as other types of incentives and alternative financing mechanisms gain in popularity (Box 4.2). The solar industry's contribution to meeting future U.S. energy needs will thus be determined by a dynamic interaction between system costs; federal, state, and local regulations and subsidies; supplier business strategies; the intensity of competition between installers; and innovations in financing.

For some PV market segments, the reported price is an artifact of the way PV systems are contracted, subsidized and financed, and of the intensity of competition among installer firms.

4.2 ESTIMATED COSTS OF PV INSTALLATIONS

Reported prices for PV systems, as shown in Figure 4.4 and Box 4.1, are easily misinterpreted as providing a basis for assessing the competitiveness of PV technology in the United States. In fact, price data are informative about the economics of some sectors but not of others. For some PV market segments, the reported price is an artifact of the way PV systems are contracted, subsidized, and financed — and of the intensity of competition among installer firms. In these segments, the reported price does not necessarily reflect what would be conventionally interpreted as system cost. To explore the relationship between installed *cost* and reported installed *price*, we

first examine specific components of installed cost using studies that are typically built up from surveys of material inputs, labor-hours required and hourly wages, and taxes.

Utility-Scale PV

The costs for an installed PV system can be usefully aggregated into different categories depending on the market segment being considered. Figure 4.7 shows a build-up of average cost for a utility-scale system, including business margin and general and administrative expenses (G&A). This type of system represents a large-scale construction project and the figure aggregates project costs — not including solar hardware and taxes — into a single engineering and construction cost, where this cost includes development costs incurred by the project developer (such as costs for land acquisition, interconnection, and system design). The estimated cost for a representative utility-scale system in the United States in early 2014 was around \$1.80/W_p. Prices of modules and

Figure 4.7 Stair Step Build-Up of Estimated Costs for a Utility-Scale PV Systemⁱⁱⁱ

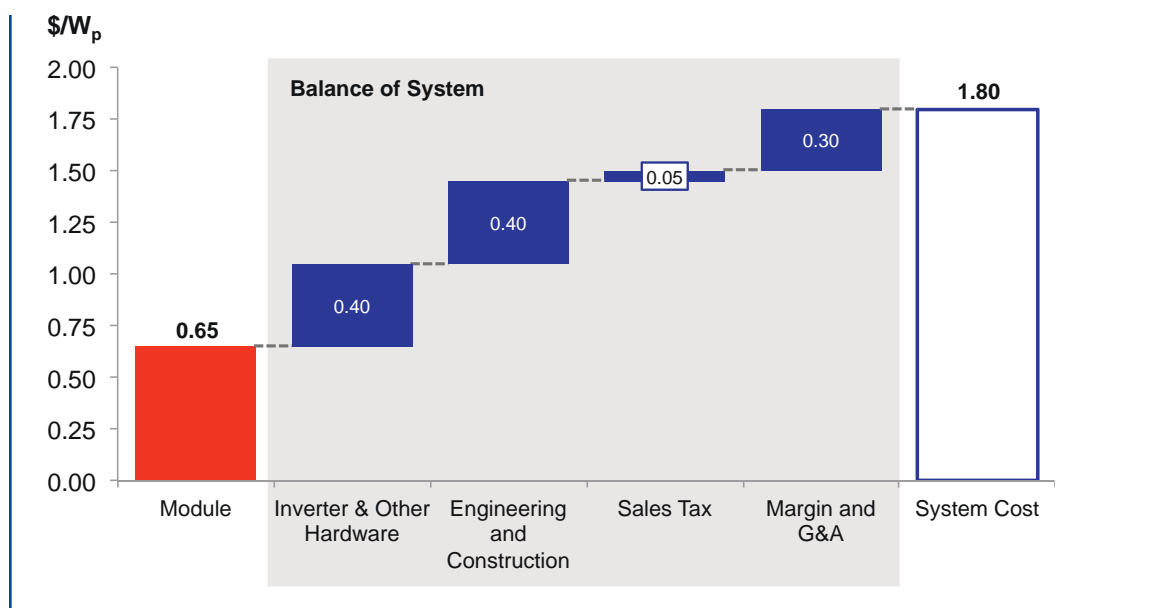

ⁱⁱⁱMIT analysis based on Solar Industry Association of America;^{1,2} Photon Consulting LLC;⁶ Feldman, Margolis, and Boff;⁸ Bolinger and Weaver;¹² and other industry and public sources.

Figure 4.8 Stair Step Build-Up of Estimated Costs for a Residential PV System^v

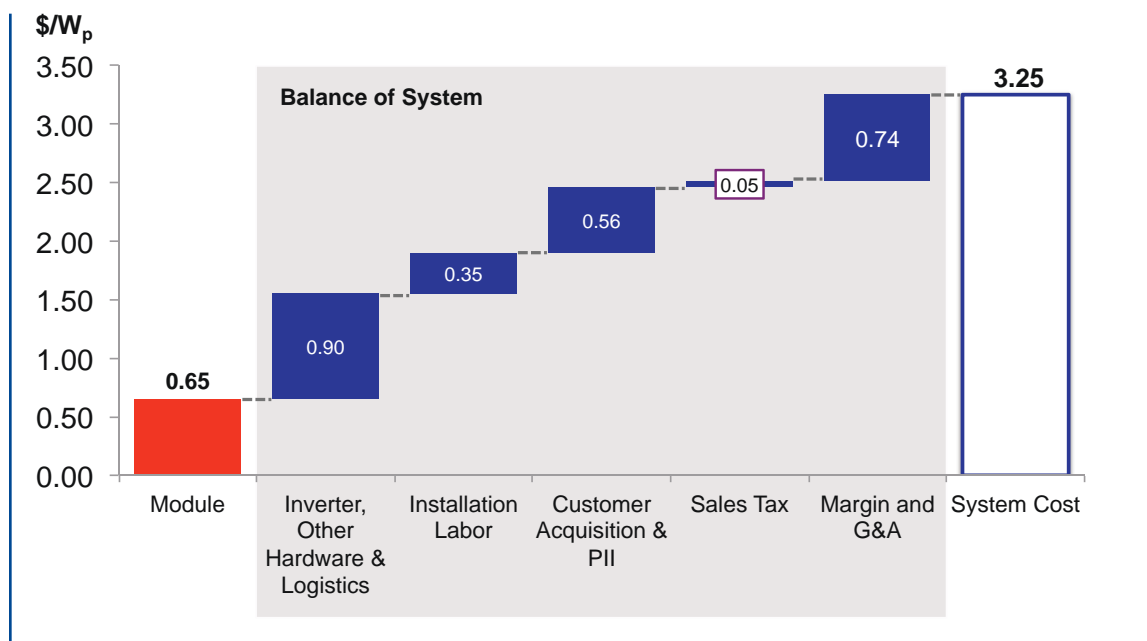

other hardware vary depending on the scale of purchase, transport cost, and other factors. However, we assume a 2014 average price of $\$0.65/W_p$ for modules (Figure 4.3) and a total of $\$0.40/W_p$ for inverters and other hardware (at $\$0.15/W_p$ and $\$0.25/W_p$, respectively).^{2,8} Total BOS costs add to $\$1.15/W_p$, a figure that includes the inverter and other hardware, engineering and construction, sales taxes, and margin and G&A.

Residential PV

Figure 4.8 shows a similar build-up of average costs for a residential PV system, applying a set of cost categories appropriate for the study of this market segment. Estimates are based on various studies and reflect market averages in 2014.^{2,13,14} The average cost of a residential system in the United States, again using appropriate assumptions for G&A and business

margin, was around $\$3.25/W_p$ in early 2014.^{iv} Module costs for residential systems are about the same as for utility systems, but because of smaller scale in design and fabrication, the cost per watt for inverters ($\$0.29/W_p$) and other hardware ($\$0.46/W_p$) is higher for residential systems. When other components of the standard bottom-up cost analysis are included, total BOS costs for residential systems amount to $\$2.60/W_p$.

Labor costs to install residential systems are conventionally estimated using information from installer surveys concerning average hours per job, multiplied by an average wage and accounting for all benefits. This input is influenced by the efficiency of the installer firm (reflecting scale and experience), by the diversity of the housing stock, and by variability in the specifications of the PV systems being installed.

^{iv}This estimate may be compared to an average installed system cost of around $\$3.00/W$ reported by the largest residential PV installer, SolarCity, in mid-2014.¹⁵

^vMIT analysis based on Solar Industry Association of America;^{1,2} Barbose, Weaver, and Darghouth;⁴ Photon Consulting LLC;⁶ NREL;⁷ Feldman, Margolis, and Boff;⁸ Ardani, Seif, Margolis, et al.;¹³ and other industry and public sources.

Costs for customer acquisition include labor hours and other marketing costs incurred by PV developers; estimates of these costs are based on surveys of time and other expenses. In addition, costs for permitting, interconnection, and inspection (PII) are important contributors to the overall cost of residential PV in the United States. The task of permitting and

Costs for permitting, interconnection, and inspection (PII) are important contributors to the overall cost of residential PV in the United States.

inspecting residential solar units is currently distributed among thousands of municipal and state authorities, each with its own regulations and requirements. In this context, the lack of standardized permitting and inspection procedures is a significant barrier to residential PV development. Similarly, there is no standard procedure for interconnection among the roughly 3,200 organizations that currently distribute electricity to retail customers.^{vi} (Less well documented are the property taxes collected by some local jurisdictions; these taxes are ignored here.) The combined total of customer acquisition and PII costs is estimated to average roughly $\$0.56/W_p$. Sales taxes (averaging $\$0.05/W_p$) also contribute to system costs in many jurisdictions.

FINDING

Balance-of-system costs are a much higher fraction of total installed system cost for residential PV compared to utility-scale plants. Establishing common rules and procedures for permitting, inspection, and interconnection — either through voluntary efforts or with the help of financial inducements — could reduce these costs, particularly in the residential sector and perhaps for commercial installations as well.

4.3 BUSINESS MODELS, COMPETITIVE CONDITIONS, AND REPORTED PV PRICES

A striking differential exists between the reported average price for residential PV systems, at around $\$4.90/W_p$ (Figure 4.4), and bottom-up estimates of the average cost to install these systems, at around $\$3.25/W_p$ (Figure 4.8). A similar price–cost differential does not appear, however, for utility-scale installations where the reported average price — at around $\$1.80/W_p$ (Figure 4.4) — is roughly consistent with estimated installed cost (Figure 4.7). This contrast between PV costs and prices in the residential and utility sectors is attributable to differences in market structure, business models and competitive conditions, and the structure of federal subsidies.

FINDING

A bottom-up estimate of cost for utility-scale PV installations yields a result that is very close to the average reported price per peak watt, indicating active competition in that segment of the PV market. In the residential sector, by contrast, a large difference exists between contemporary reported prices and estimated costs.

The fact that reported prices closely track estimates of developer costs suggests that strong competition pervades in the construction of utility-scale PV and the sale of either the PV plant itself or its output through a power purchase agreement (PPA). The residential market is more complex and the price–cost gap in this segment indicates that it is also less competitive. The residential business involves both the direct sale of PV systems to customers and, as has become the norm in many regions, deals involving third-party ownership in which the customer either makes lease payments or pays for the kilowatt-hours (kWh) the

^{vi}For an overview of the U.S. electric system, see Kassakian and Schmalensee.¹⁶

PV system generates through a PPA. The commercial PV market spans the range of these different business models. We begin with the contemporary utility-scale PV business.

Utility Sector

There are several ways for utilities to add solar generation, ranging from a formal bidding process to the review and acceptance of proposals submitted by developers. Whatever the approach taken by the utility, solar developers compete for this business, which leads to continuous pressure for cost reductions that ultimately are passed through to the buyer of the PV plant or to the buyer of its electricity output through a PPA. Subsidies, including the federal ITC and accelerated depreciation, also play a role in utility-scale installations, because developers can use these subsidies to make their offers more attractive. Whether a developer is selling the solar facility itself or the power it produces, these subsidies reduce the effective price per kWh to the utility.

Figure 4.9 illustrates the effect of federal subsidies on the cost of a utility-scale solar facility. In this example, we assume that the unsubsidized, installed cost of the average system is around $\$1.80/W_p$ (see Figure 4.7). We further assume that the buyer ultimately realizes the full value of available federal subsidies (a total of $\$0.76/W_p$). This reduces the effective cost of the system to $\$1.04/W_p$.

To capture the full value of federal subsidies, the beneficiary must have sufficient taxable income. In cases where the developer or buyer of the solar asset is sufficiently profitable, as is likely the case for a large electric utility, fully monetizing these subsidies is not a problem. However, some PV developers — particularly those who retain ownership of PV facilities and sell the power they generate via PPAs — may not have sufficient taxable income to fully monetize the value of the subsidies. These developers must turn to the tax equity market, in effect partnering in the ownership of PV assets with institutions that do have sufficient income to

Figure 4.9 Impact of Federal Subsidies on the Effective Cost of Utility-Scale PV

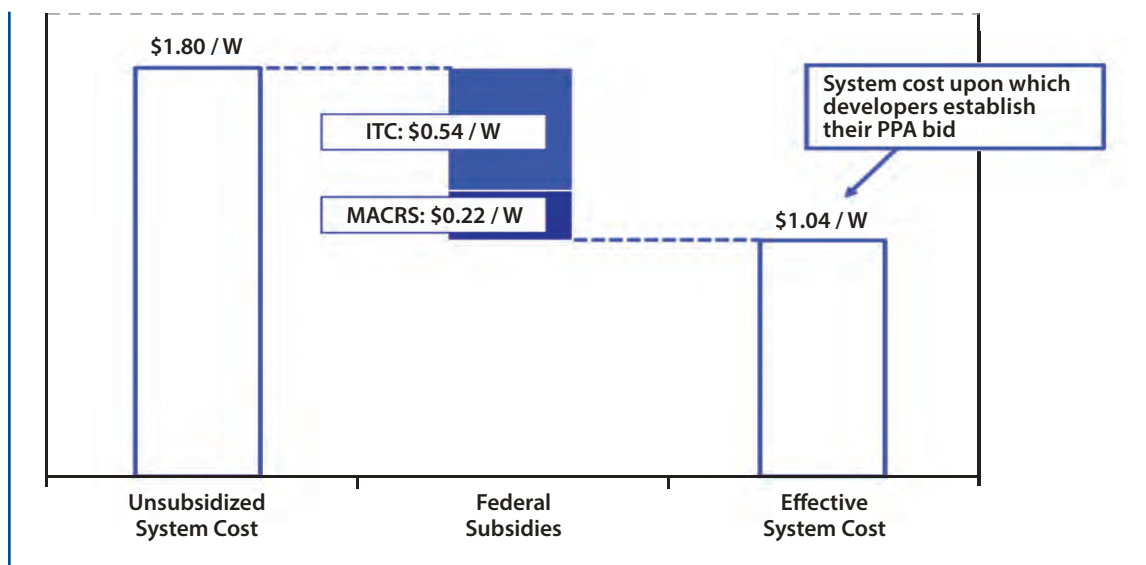

take advantage of the subsidies (see Box 4.2). Though straightforward in theory, tax equity financing is anything but simple in practice and its use has a number of disadvantages. Most important for utility-scale PV, the transaction costs incurred in accessing the tax equity market mean that a portion of the subsidy is not available to lower the cost of the PV installation.^{vii}

The transaction costs incurred in accessing the tax equity market mean that a portion of the subsidy is not available to lower the cost of the PV installation.

BOX 4.2 TAX EQUITY AND ITS ROLE IN SUPPORTING SOLAR INVESTMENT

The investment tax credit (ITC) has been the most important federal-level mechanism for subsidizing solar energy deployment since it was enacted in 2005. Owners of solar facilities, both commercial and personal, can claim a federal tax credit of 30% of a facility's eligible "cost basis."¹⁷ At the end of 2016 the credit available to personal taxpayers is scheduled to expire and the credit for commercial taxpayers will fall to 10%.^{18,19}

Accessing the tax equity market has several drawbacks from a developer's perspective. First, it involves complex commercial structures and contracts — including various changes in the division of asset ownership over time between the developer and the tax equity investors. Typically, tax equity investors also expect to achieve a commercial return, and this reduces the amount of the ITC captured by the developer. The actual yields achieved by tax equity investors are not public, but unlevered after-tax returns of between 8% and 10% seem to be the norm. These are generous returns considering that the underlying assets — usually solar facilities producing income under a long-term power purchase agreement — are low risk. Also, the yields on activity to support third-party residential solar are higher than for investments in utility-scale projects.^{20,21}

Tax equity investors can achieve relatively high yields from solar investments because of the limited number of participants in tax equity markets. Only 20 or so institutions engage in this business, and even fewer participate in solar deals.^{20,21} Google and some utilities, including Pacific Gas & Electric (PG&E) and San Diego Gas & Electric (SDG&E), have entered, but the tax equity market is still dominated by a small number of large banks and insurance companies. Although in theory a larger pool of capital should be available, the fact that investors need to possess very specialized internal capabilities has tended to limit interest in solar projects to financial institutions familiar with energy investing.

The complexity and cost of arranging tax equity investments also tends to place a lower limit on the size of the deal required to attract investor interest. Typically, individual deals are no smaller than \$50 million, with the average being \$100 million or larger.^{20,21} Deals of this size can be achieved relatively easily with utility-scale projects, but the number of residential and commercial developers who can access tax equity financing is quite limited. Practically speaking only very large, third-party residential developers have been able to tap the tax equity market, since only they can aggregate the thousands of individual residential systems needed to comprise a large enough asset portfolio.

(continued)

^{vii}In Chapter 5, calculations of the cost of PV generation make alternative assumptions about the cost of tax equity financing.

BOX 4.2 TAX EQUITY AND ITS ROLE IN SUPPORTING SOLAR INVESTMENT

(continued)

As mentioned above, the actual mechanics of tax equity financing are complex. In addition, the individualized nature of tax-equity deals leaves little room for standardization. That said, most tax equity deals for solar projects utilize one of three types of structures, each of which has advantages and disadvantages:

- partnership or “partnership flip”
- sale–leaseback
- inverted lease

The partnership flip is the most common tax equity deal structure used for solar financing — it accounts for approximately 60% of all deals. As the name suggests, in this type of deal the developer and investor establish a joint partnership that owns the solar asset.²² In return for investing in the project, the tax equity investor initially receives 99% of the tax benefits and up to 99% of the revenues generated by operating the solar asset (after some agreed-upon percentage of the developer’s equity is returned) for the length of time needed to achieve a predetermined return. Once the investor’s goals are met, ownership of the solar asset “flips” to the developer who then receives 95% of all cash and tax benefits, and can buy out the investor completely if desired.

The second type of investment structure is the sale–leaseback. It accounts for about 25% of all tax equity deals for solar projects. Instead of supplying 40% of the project’s capital requirements (as in the partnership flip model), the investor buys the entire project and then immediately leases it back to the developer for a fixed period. This eliminates the developer’s need for long-term project debt. The sale–leaseback offers the investor a well-defined return in the form of lease payments, while allowing the developer to capture any immediate upsides if the project performs better than predicted. A drawback of the structure is its requirement that 20% residual project value must remain at the end of the lease, which makes investor buy-out more expensive and adds risk.

The third deal structure sometimes used for solar tax equity investments is the inverted lease, or lease-pass-through. This structure accounts for approximately 15% of all solar tax equity deals.²² Inverted leases are more complex than the other options. Essentially the developer leases the project to the investor, and passes through the federal tax benefits. A key advantage of the inverted lease is that the developer retains full ownership, thus avoiding a buyout. At the same time, the investor receives meaningful cash flows from the start of project operation. A drawback of this structure is that it requires developers to provide significant upfront capital.

Residential Sector

Of the two business models that currently dominate the residential PV market, the direct sale model is the simplest: a solar company supplies and installs a system on the roof of the customer’s home for a negotiated price. Actual installation may be handled by the company’s own staff, or by contracted installers. The solar company is typically responsible for designing the system and satisfying PII requirements. The homeowner receives associated subsidy

benefits, including the ITC, which is taken as a credit against the homeowner’s federal income tax. Under the third-party/lease business model many companies are involved in a given residential installation, including not only the developer and the developer’s subcontractors, but also the developer’s financial agents through the tax equity market. These agents may own the system under a shifting set of arrangements and somehow share the federal subsidies that accompany it (Box 4.2).

Figure 4.10 plots the distribution of prices reported in California for direct sale and third-party-owned residential PV systems in 2013. There is nothing remarkable about the direct sale data other than how broad the price distribution is. In contrast, the prices reported for third-party-owned systems show pronounced concentration at a few price points. These frequently reported price points represent the installations of one or a few companies; generally they reflect a portfolio average for the year. The median residential PV prices reported in California for 2013 — at \$4.95/W_p for direct sales and \$5.10/W_p for third-party transactions — are consistent with the national figures in Figure 4.4. But as noted in the foregoing discussion they are substantially higher than bottom-up estimates of average installed cost (Figure 4.8). The reasons for this discrepancy can be found in the structure of residential PV markets.

Direct Sale

Early in the development of the residential PV market, most systems were deployed via direct sales, with developers and homeowners negotiating a price for each installation. In this business model the homeowner must have the financial capacity to either pay for the system directly or take on the necessary debt; in addition, to benefit from available federal subsidies, the homeowner must have a personal income tax obligation sufficient to use the ITC. Moreover, the homeowner takes on the burden of many associated transactions, including those involved in claiming any additional state or local incentives.

The price of direct-sale systems, as illustrated by data from the California Solar Initiative, can be expected to vary with the difficulty of the installation, but also with the level of installer

Figure 4.10 Distribution of Reported Prices for Residential Direct Sale and Third-Party-Owned PV Systems in California (2013 data)¹¹

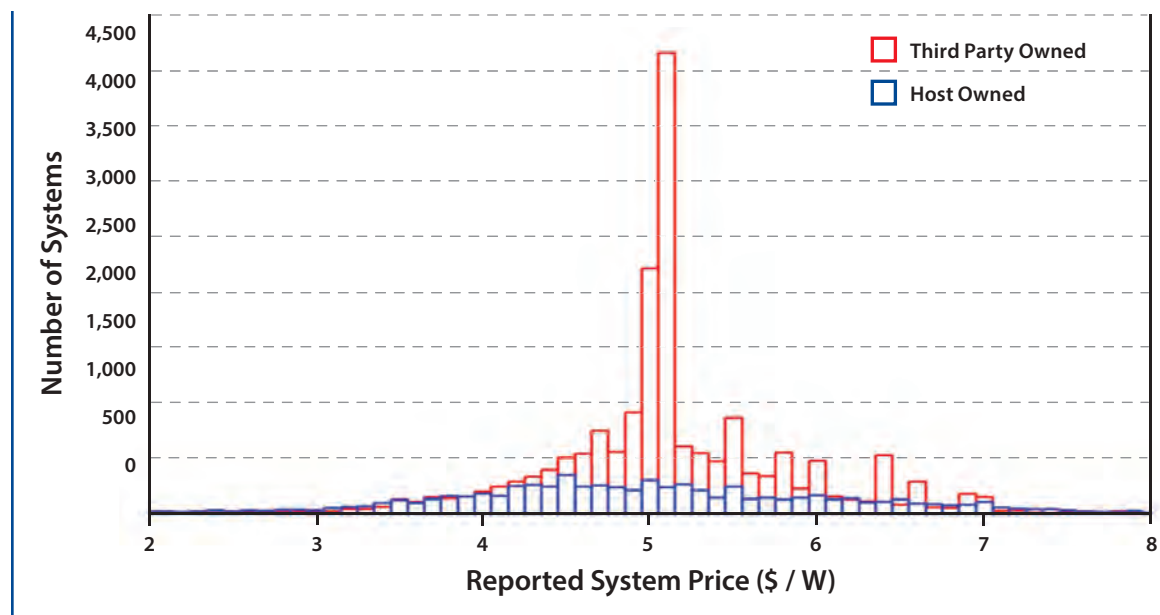

competition in the local solar market. Using our estimate of $\$3.25/W_p$ for the national average cost of an installed residential PV system, Figure 4.11 shows price effects in two types of markets: one that is highly competitive and one that is immature or uncompetitive. Under intense competition, the average price of residential systems deployed using the direct sales model would be driven towards the unsubsidized cost or $\$3.25/W_p$, as illustrated on the left side of the figure. Assuming that the homeowner can take full advantage of a $\$0.98/W_p$ subsidy under the 30% federal ITC, the net price to the purchaser is $\$2.27/W_p$.^{viii}

Suppose, on the other hand, that the customer's willingness to pay (WTP) for a PV system is greater than $\$2.27/W_p$ — in our example,

we assume that the customer's WTP is $\$3.15/W_p$ or approximately 39% more than the net price in the competitive case. If this customer negotiates to buy a PV system with imperfect information in a local market that lacks intense supplier competition, he could pay as much as $\$4.50/W_p$. This figure is consistent with reported price data from the California Solar Initiative. Priced at $\$4.50/W_p$, the 30% ITC would yield a $\$1.35$ credit, reducing the customer's net outlay to the $\$3.15/W_p$ — an acceptable price given the assumed willingness to pay. This example suggests that differences in competitive conditions among local markets, augmented by the effect of the ITC, likely contribute to the wide distribution of reported prices shown in Figure 4.10.

Figure 4.11 Cost, Subsidy, and Pricing in Residential Installations: Direct Sale

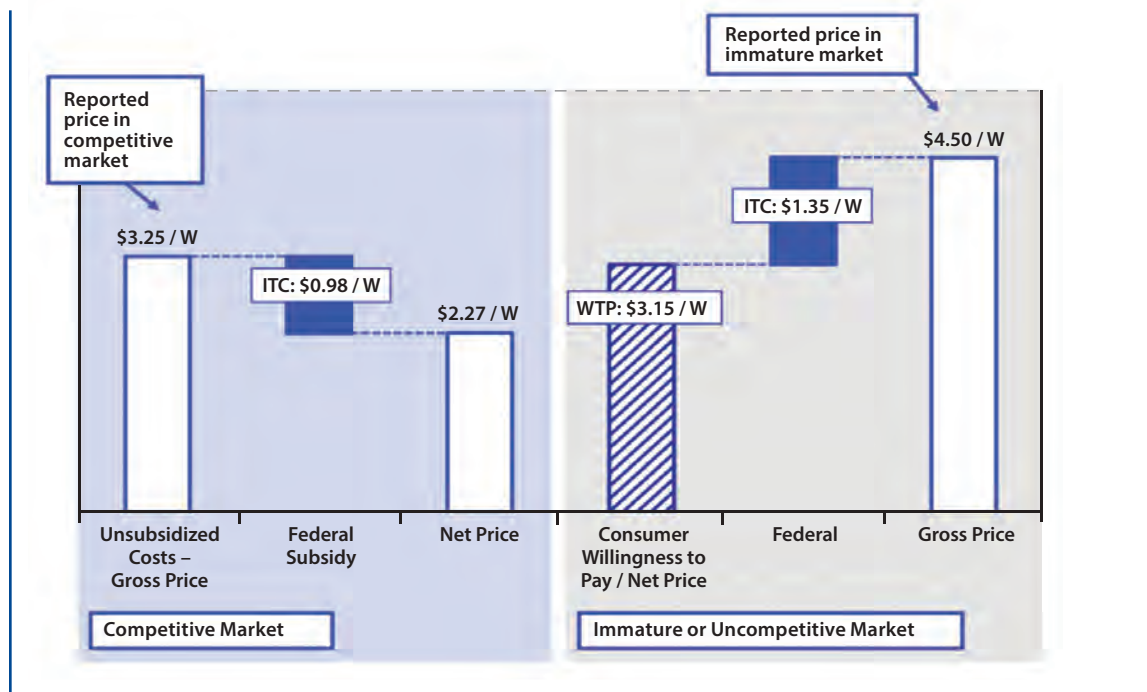

^{viii}State and local subsidies, not shown in this example, also may influence the system price that would be acceptable to the customer. Note that an individual taxpayer cannot take advantage of accelerated depreciation.

Third-Party/Lease

Customers who install a third-party-owned system enter into either a lease or a PPA contract with a third-party provider. Typically these contracts are for 20 years, sometimes with an option for renewal, and the terms are generally set in relation to the customer's retail utility rate (see Box 4.3).^{ix} The prominent role of the retail electricity rate in the third-party model means that lease prices for identical PV units can differ widely among regions

depending on local utility rates. From a homeowner's perspective the major attraction of the third-party model, aside from reducing or eliminating utility bills, is that it provides access to solar generation without a large upfront capital expenditure, while also providing guarantees with respect to system performance and maintenance. Furthermore, for reasons discussed later in this chapter, the lease model can — depending on the price of the lease — enable higher subsidy capture than is possible through the direct-sale model.

BOX 4.3 TAX EQUITY AND ITS ROLE IN SUPPORTING SOLAR INVESTMENT

Under the third-party or leasing model, the customer allows the third-party system owner to install a PV system on his or her property. The customer then pays the system owner a pre-agreed fee, either a lease payment or a PPA rate ($P_{PV,t}$), over the duration of the contract. The PPA case is illustrated in the figure. These contracts generally contain many details, but a common feature of most is an initial price ($P_{PV,0}$) that in many cases is set in competition not with

other solar suppliers, but with the local electric utility. The effective initial price per kWh might be 15% or so below the customer's highest block rate from the electric utility, with an annual escalator that could range from 0% to 4.0% or more.

Under lease contracts, the developer tends to bear any risk associated with the future performance of the PV system while the customer bears the price risk that originates in the unknown path of future utility rates.

Figure 4.12 PV Prices under the Leasing Model of PV Sales

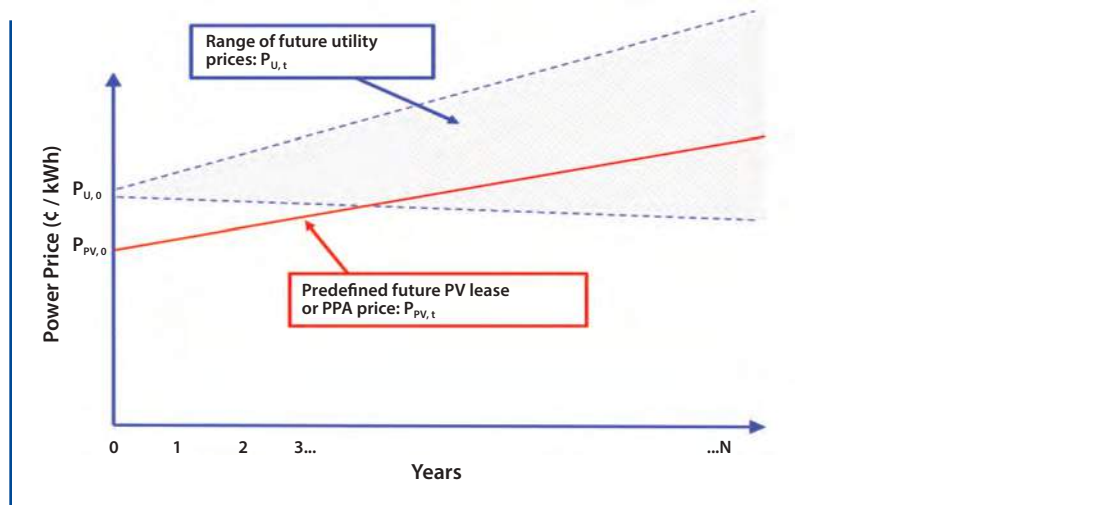

^{ix}SolarCity is the largest of the residential PV integrators currently using the leasing model. In its filings with the Securities and Exchange Commission, SolarCity states, “We believe that our primary competitors are the traditional utilities that supply energy to our potential customers.”²³

Largely because it avoids up-front costs to the customer, the third-party model has opened up a significantly greater market for residential solar than existed under the direct sales model alone. Over the past few years, third-party ownership has become the dominant business model in the residential solar sector and today it accounts for 60%–90% of residential PV installations in major markets such as California, Arizona, and New Jersey.⁸

FINDING

The third-party ownership business model has expanded the residential PV market to a larger customer base in the states where it is available.

Extra caution is needed when interpreting price data on third-party systems because much of the reporting is based on estimated system “value” and does not reflect an arms-length transaction price. This reporting on estimated value rather than price comes about because some third-party providers operate as vertically integrated businesses. Non-integrated third-party providers purchase their systems from installers, and the price they pay the installer is typically the price reported. By contrast, vertically integrated providers (increasingly the largest players in the market) often handle the entire customer acquisition and system installation process in-house. Because their systems are not bought and sold in arms-length transactions, these entities tend to report system prices in terms of their estimated fair market value (FMV).⁷ Reporting on FMV is what leads to the high concentration of systems at particular price points in Figure 4.10, as third-party providers often estimate only a few representative FMVs for large tranches of systems. The concept of FMV is central to many applications of the third-party business model, as it can be used to establish the cost basis for calculating federal subsidies.

Largely because it avoids up-front costs to the customer, the third-party model has opened up a significantly greater market for residential solar than existed under the direct sales model alone.

The U.S. Internal Revenue Service defines FMV as “the price at which the property would change hands between a willing buyer and a willing seller, neither being under any compulsion to buy or sell and both having reasonable knowledge of relevant facts.”²⁴ Under guidance provided by the U.S. Treasury, a solar developer is given considerable latitude in choosing among three methods of assessing FMV and thereby establishing the subsidy cost basis:²⁵

- The **cost method** is the most straightforward method for estimating FMV. It is based on the assumption that an informed purchaser will pay no more for a system than the cost of replacing it.
- The **market method** relies on data from recent sales of comparable systems to estimate FMV.
- The **income method** estimates FMV based on the cash flows generated by the system.

With this flexibility a developer can choose the FMV assessment method that yields the highest cost basis and thus generates the greatest federal subsidy. Use of the income method, in particular, can generate an interesting and often-unappreciated circularity because it yields a cost basis for calculating the federal subsidy that is based on project income, part of which comes from the subsidy itself.

Equations 4.1 to 4.3 illustrate this feature of the income method. The FMV or cost basis of a leased system is the sum of the present value of the system's future income streams under the terms of its lease or PPA, plus any income from subsidies:⁷

$$FMV = PV_{Lease} + PV_{Subsidy}. \quad (4.1)$$

The present value of federal subsidies includes the 30% federal ITC on the system's cost basis (CB_{ITC}), plus another approximately 8% for MACRS. Hence Equation 4.1 can be rewritten as:

$$FMV = PV_{Lease} + 0.38 \times CB_{ITC}. \quad (4.2)$$

Given that the FMV defines the cost basis, Equation 4.2 can be simplified to:

$$CB_{ITC} = PV_{Lease} + 0.38 \times CB_{ITC} \quad (4.3)$$

or

$$CB_{ITC} = \frac{PV_{Lease}}{0.62}.$$

Equation 4.3 is important because it describes a situation where the cost basis for purposes of calculating the federal subsidy is directly linked to the present value of the system's lease, rather than to the cost of the system. In situations where the present value of the lease is greater than 62% of the cost of installing the system, the cost basis — and hence the subsidy yielded by using the income method — will be greater than what would have been yielded if the subsidy were calculated on the basis of the system's actual cost.

A graphical illustration of this dynamic is shown in Figure 4.13, which compares the subsidies yielded by using the cost and income methods. The figure assumes a single

third-party owned system with an unsubsidized capital cost of $\$3.25/W_p$. For purposes of this illustration, we assume a lease that has a present value of $\$3.00/W_p$. Note that this example presumes a less-than-fully-competitive market. Under intense competition the present value of the lease would be driven down closer to the point where the present value of total income ($\$4.24$ or $\$4.84/W_p$ in the figure, depending on the method used to calculate cost basis) would just cover the unsubsidized $\$3.25/W_p$ capital cost.

In the cost method example shown on the left side of the figure, the third-party provider claims the system's $\$3.25/W_p$ capital cost as the cost basis for calculating federal tax subsidies. The ITC benefit to the provider is then 30% of $\$3.25/W_p$ or $\$0.98/W_p$. Additionally, the provider takes advantage of MACRS accelerated depreciation, capturing an additional benefit equal to approximately 8% of the cost basis or $\$0.26/W_p$ in present value terms. Combined with the $\$3.00/W_p$ present value of the lease, a combined $\$1.24/W_p$ in tax benefits (assuming these benefits can be fully monetized) means that the system is worth $\$4.24/W_p$ to the third-party provider.

The right side of the figure illustrates a scenario where the third-party provider chooses to calculate the system's cost basis using the income approach. In this situation, the cost basis or FMV is the sum of the lease value and the federal subsidies. Combined, the ITC and MACRS benefits amount to 38% of the FMV, meaning the present value of the lease equals 62% of the FMV. Given that the $\$3.00/W_p$ present value of the lease is 62% of the system's FMV, the FMV under this approach is $\$4.84/W_p$ and the corresponding federal tax subsidies amount to $\$1.84/W_p$.

Figure 4.13 Impact of Method Used for Cost Basis Calculation on Income Potential of a Third-Party-Owned Solar System

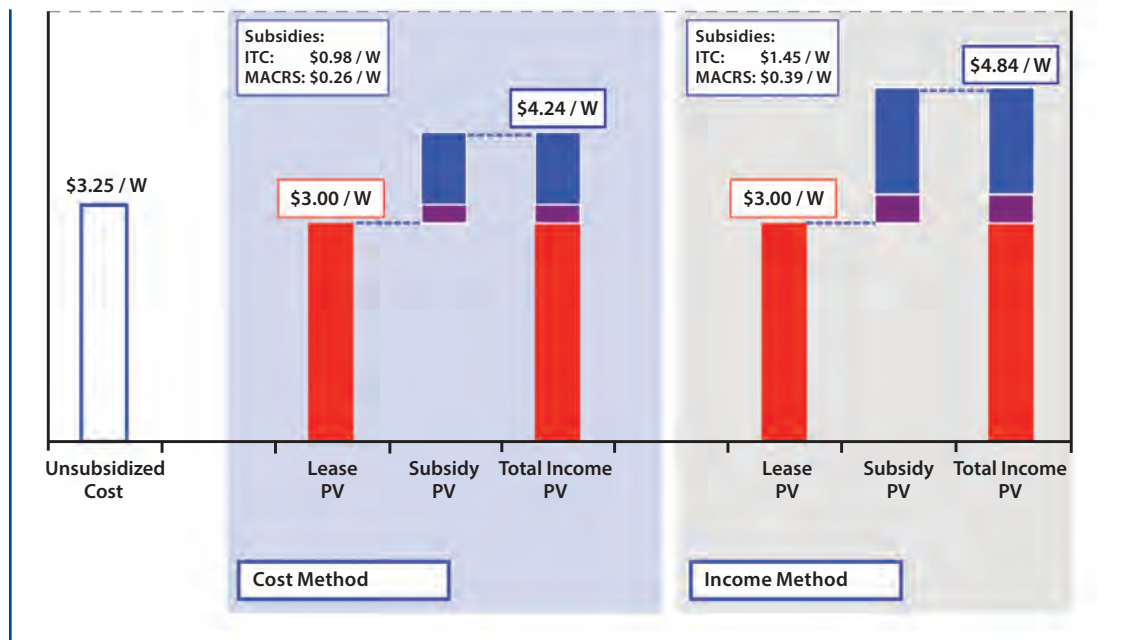

In other words, use of the income method in this example results in total subsidies of $\$1.84/W_p$, approximately 48% higher, for the same system, than if the cost method were used as the basis for federal tax benefits. However, it is also worth pointing out that as lease prices fall, applying the income method does less to amplify federal tax benefits. In fact, in a highly competitive market where the present value of leases would be expected to fall very close to 62% of system cost, the subsidies yielded by the income and cost methods converge to the same value.

In sum, FMV estimates that are calculated using the income method are poor indicators of PV competitiveness, since third-party owners link the value of PV systems (and hence the subsidy they capture) to utility rates within their target markets. The use of the income method to establish fair market value effectively decouples the concept of PV market value from underlying system cost. Take, for example, two systems with identical costs — one installed in

Texas and the other in California. The California system would report a higher FMV and would almost certainly get a higher federal subsidy, because of higher electric rates in California. Moreover, because the income method involves valuing multi-year cash flows, it is sensitive to the assumed discount rate.

FINDING

In a less than fully competitive market, allowing use of the income method to calculate federal solar subsidies can result in fair market values that exceed system costs and thus lead to higher federal subsidies than if fair market values equaled system costs.

The use of the income method to establish fair market value effectively decouples the concept of PV market value from underlying system cost.

The key to the solar industry's future, particularly in the residential market, will be the evolution of other components of BOS cost, plus increased competition to drive system prices closer to the installed cost.

It also is worth noting that, when federal subsidies are based on investment cost and the income method is used to calculate investment cost, large differences can exist between sectors in terms of the level of subsidy provided per watt. In the examples discussed here, the federal subsidy for a utility-scale project is $\$0.76/W_p$, whereas under the income method commonly used for residential solar investments it is $\$1.84/W_p$.

FINDING

The existing system of federal solar subsidies, because it is based on capital investment and allows for different methods of calculating the cost basis, leads to subsidies per watt of deployed capacity that can differ appreciably, not only between the utility and residential sectors but also, in the case of residential systems, between different regions depending on local utility rates.

4.4 THE OUTLOOK FOR FUTURE PV COSTS AND PRICES IN THE UNITED STATES

For PV to be competitive in U.S. electricity markets (see Chapter 5), PV cost and price will need to continue to fall. Prices for modules and inverters may continue to decline, but the key to the solar industry's future, particularly in the residential market, will be the evolution of other components of BOS cost, plus increased competition to drive system prices closer to the installed cost. The potential for reducing BOS costs, particularly in the residential market, can be seen in Germany where PV costs and prices are lower than in the United States, even though prices for modules and inverters are about the same.

Cost Comparison with Germany for Residential Systems

In 2013 the average reported cost for residential PV installations in Germany was around $\$2.05/W_p$, approximately $\$1.20/W_p$ cheaper than our estimate for the United States (Figure 4.8).^{5,26,27} Figure 4.14 shows where this disparity originates. The most striking cost differences are in the categories of consumer acquisition (marketing, individual system design, etc.) and PII. Germany's greater population density and higher concentration of residential PV have helped increase familiarity with solar technology and facilitate contact with potential customers. The number of residential PV installations per 1,000 households in Germany is about nine times that in the continental United States, and about three times the concentration in California.²⁸ Costs for permitting and inspection can differ greatly across the thousands of political jurisdictions in

Figure 4.14 Non-Hardware BOS Costs in the U.S. and German Residential PV Markets (2013 data)^x

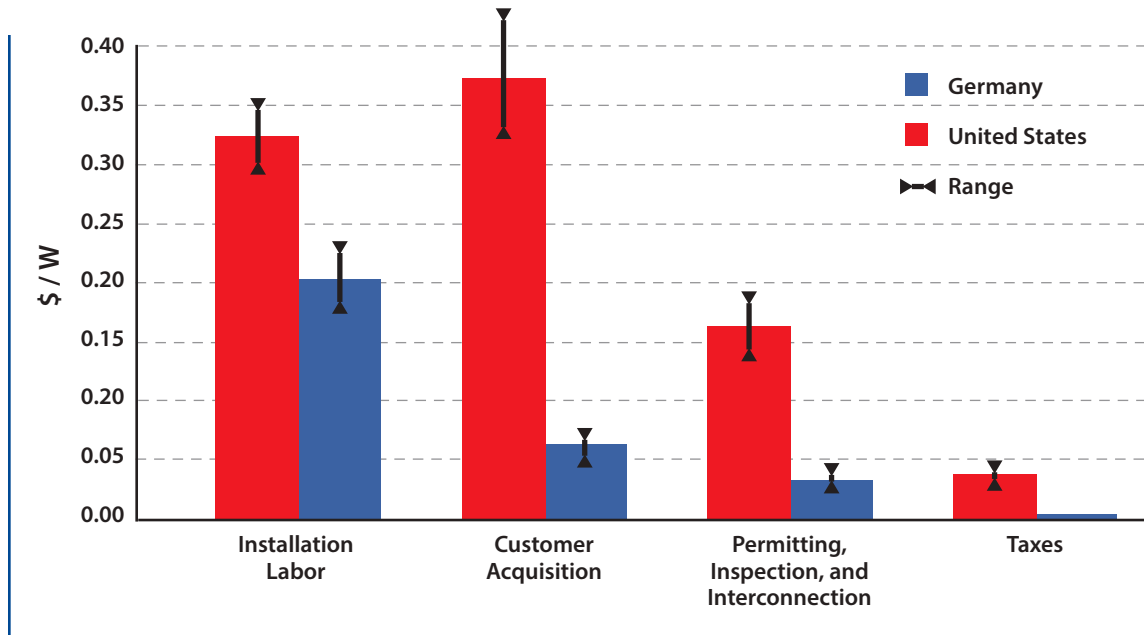

the United States, while in Germany there is greater standardization. German interconnection procedures are streamlined as well; by contrast, installers in many American states must interact with several investor-owned utilities and many municipal utilities and co-ops as well.

Installation labor is more expensive in the United States, despite similar wage rates in the two countries, in part because of differences in labor type. For example, some U.S. jurisdictions require a licensed electrician for parts of the job that in Germany can be performed by lower-wage workers. But the main difference in residential installation labor costs appears to be attributable to installer efficiency, likely due to greater accumulated experience in Germany, but also perhaps aided by a more favorable regulatory structure and housing stock.⁵

FINDING:

Greater installer experience and efficiency have contributed to lower residential PV prices in Germany compared to the United States, but part of the difference is also attributable to differences in government and regulatory structure, and to differences in the structure of the housing stock.

^xMIT analysis based Solar Industry Association of America;² Morris, Calhoun, Goodman, and Seif;⁵ Ardani, Seif, Margolis, et al.;¹³ Wirth;²⁶ and Seel, Barbose and Wiser.²⁷

BOX 4.4 EMERGING MECHANISMS FOR FINANCING SOLAR INVESTMENT

Many factors will influence the future scale and economics of solar power. Two of the most important of these factors are access to capital and cost of capital. To date, the solar industry has had to rely heavily on three sources of capital for deploying solar technology: developer equity, tax equity, and project debt. Although each of these sources has played an important role in assisting the solar industry through its early stages of commercial development, their limited availability and relatively high cost means that none of them is well suited to supporting the much larger levels of solar investment that are envisaged for the coming decades.

The limits of traditional sources of capital for solar investment have recently begun to stimulate a range of important financial innovations designed to allow the solar industry to access public capital markets, with their much greater depth and often lower costs. Examples of financial vehicles that are bought, sold, and priced in open and liquid markets include asset-backed securities (ABSs), publically traded debt products, and traded pass-through entities such as master limited partnerships (MLPs) and real estate investment trusts (REITs). A recent study comparing the cost of these financial vehicles with that of the contemporary tax equity market suggests that the ability to access public capital could reduce solar costs by hundreds of basis points.²⁹

The two mechanisms for accessing public capital markets that have so far gained the most traction in the solar industry are ABSs and so-called yield-cos. ABSs pool and securitize cash flows from a large number of income-generating assets. The cash is then distributed through tranches with varying risk-based yields. SolarCity, one of the largest distributed solar developers, has been in the vanguard of utilizing ABSs. In 2014 alone, SolarCity raised several hundred million dollars with a set of ABS issuances that offered yields ranging from 4% to 5.5%.

Since 2013, the growing popularity of yield-cos has provided a pathway for bringing public capital to solar PV deployment, particularly utility-scale projects, in a manner similar to the way MLPs are used in the energy transport and mineral extraction industries. Yield-cos are publically traded corporations that own and invest in operating assets with predictable cash flows, such as solar installations with PPAs. Because they do not engage in other, riskier activities, such as project development, yield-cos can be attractive to investors despite their modest yields. Several major independent power developers and producers with solar assets have established yield-cos including NRG Energy, Inc. and NextEra Energy. NRG's yield-co offered a yield of 5.45% when it was formed in 2013, but it traded at significantly higher prices in 2014, with yields accordingly falling toward 3%. Other yield-cos have similarly outperformed as the yield-co structure has proved attractive to investors interested in the types of stable returns that solar installations can offer.

Interest in a variety of debt products designed to support solar deployment is also increasing. Efforts are underway to utilize states' and municipalities' extensive expertise in issuing bonds to help finance solar investments. Hawaii, for example, has instituted a green infrastructure bond program that is being used to finance solar investments across the state. Activity is also occurring at the retail banking level as a growing number of lenders see solar projects as a commercial opportunity with a risk profile that is becoming increasingly well understood. Major third-party residential solar developers have also begun offering loan products designed to allow homeowners to purchase systems outright rather than lease them. SolarCity's MyPower loan product is one prominent example.

Despite the recent increase in solar financing options, hurdles remain. In particular, there is still a need for standardization in the areas of documentation and system performance assessment to help public capital markets feel fully comfortable with the risk profiles of solar assets.

Forces are at work that will continue to drive down both the reported price of PV systems in the United States and the underlying installed system cost. The greatest room for improvement exists in the residential sector.

Prospects for Further Reductions in PV Costs and Prices

Forces are at work that will continue to drive down both the reported price of PV systems in the United States and the underlying installed system cost. The greatest room for improvement exists in the residential sector. Figures 4.11 and 4.13 show how, under both direct sale and third-party/lease arrangements, the reported price for residential systems can be substantially above the estimated installed cost. And comparing estimates of installed cost (Figure 4.8) to reported average prices in California (Figure 4.10) reveals a substantial gap between PV cost and prices in the residential sector.

Because of the complexities of the residential sector there will always be market segmentation and less than perfect competition among residential PV installers. As a result, the reported average price for an installed system cannot be expected to equal the average cost. But growing competitive pressures will tend to force prices toward convergence with costs. Even with the current federal ITC and accelerated depreciation, increased competition among suppliers will put downward pressure on the lease rate (shown as “lease PV” in Figure 4.13), cutting the dollar amount of the subsidy and bringing reported prices closer to the installation cost. Competition among firms that lease residential PV systems has been somewhat retarded by the scale required for these firms to access tax equity markets, but ongoing financial

innovations designed to boost solar developers’ access to less costly capital would lower this barrier (see Box 4.4). Moreover, wherever third-party sales are allowed, PV suppliers also have the option of pursuing direct sales. The likely emergence of a richer portfolio of retail solar financing mechanisms will open the direct sale option to a wider set of households — further increasing competition for PV customers under these two business models.

These competitive pressures will direct ever more urgent supplier attention to opportunities for reducing installed PV system costs. As discussed in Chapter 2 of this report, there is long-term potential for very significant overall system cost reductions arising from the development and deployment of new PV technologies. However, given current PV module designs, the greatest near-term potential for PV cost reductions lies in aggressively targeting BOS costs.

The greatest near-term potential for PV cost reductions lies in aggressively targeting BOS costs.

Reducing installation labor costs is a natural focus for the industry, but additional cost reductions in this area will come naturally with market growth. For example, increasing scale alone will increase consumer familiarity with PV technology and lower the expense of consumer acquisition — a very significant cost today. Also, whereas some PII costs appear to be driven by the fragmented U.S. political structure and the great diversity of distribution utilities, opportunities exist to moderate their influence on overall PV cost. For example, some states, such as Vermont,³⁰ have instituted a streamlined permitting process, and there are designs for standardized procedures that might be adopted more broadly.³¹ Absent major breakthroughs in the commercial position

of new module technologies, we believe the current German average system cost of approximately \$2.05/W_p likely represents the lower limit of what can be achieved through further cost reductions in the U.S. residential PV market. The implications of a \$2.05/W_p system average cost for the competitiveness of residential solar are tested in Chapter 5.

The current German average system cost of approximately \$2.05/W_p likely represents the lower limit of what can be achieved through further cost reductions in the U.S. residential PV market.

FINDING

Prices for utility-scale PV installations are limited by intense developer competition. Some of the factors that lead to higher U.S. prices for residential PV will be mitigated by growing market scale and increased competition. However, some balance-of-system costs for residential systems will likely remain high because of the structure of U.S. political jurisdictions and the diversity of distribution utilities.

In the U.S. utility sector, reported prices for PV systems are close to estimated costs, indicating strong competition among suppliers. The cost of utility-scale installations has been falling (Figure 4.4), largely because of declining prices for modules and inverters.³² Further reductions in module costs are projected, but the rate of improvement on this front is likely to become increasingly incremental. Nevertheless, scale, ongoing innovation, and rapidly increasing expertise in project development will continue to yield BOS cost reductions. These gains, coupled with greater access to the lower cost capital now becoming available to the solar sector means the competitiveness of utility-scale solar will continue to improve over the medium term.

REFERENCES

- ¹U.S. *Solar Market Insight Report – 2014 Year-in-Review*. Solar Industry Association of America. (2014). <http://www.seia.org/research-resources/solar-market-insight-report-2014-year-review>
- ²U.S. *Solar Market Insight Report – 2014 Q4*. Solar Industry Association of America. (2014). <http://www.seia.org/research-resources/solar-market-insight-report-2014-q4>
- ³*The Open PV Project – The Real-time Status of the Solar Photovoltaic Market in the U.S.* National Renewable Energy Laboratory. <https://openpv.nrel.gov/index>
- ⁴G. Barbose, S. Weaver, and N. Darghouth. *Tracking the Sun VII - An Historical Summary of the Installed Price of Photovoltaics in the United States from 1998 to 2013*. Lawrence Berkeley National Laboratory. (Sep 2014). http://emp.lbl.gov/sites/all/files/Tracking%20the%20Sun%20VII_Report_0.pdf
- ⁵J. Morris et al. *Reducing Solar PV Soft Costs: A Focus on Installation Labor*. Rocky Mountain Institute. (Dec 2013). http://www.rmi.org/Knowledge-Center/Library/2013-16_SimpleBoSRpt
- ⁶Private Communication with Photon Consulting LLC regarding module and inverter prices.
- ⁷U.S. *Residential Photovoltaic (PV) System Prices, Q4 2013 Benchmarks: Cash Purchase, Fair Market Value and Prepaid Lease Transaction Prices*, National Renewable Energy Laboratory, Technical Report NREL/TP-6A20-62671, 2014. <http://www.nrel.gov/docs/fy15osti/62671.pdf>
- ⁸D. Feldman, R. Margolis, and D. Boff. *Q2/Q3 '14 Solar Industry Update*. SunShot, U.S. Department of Energy. (Oct 31, 2014). http://www.google.com/url?sa=t&rct=j&q=&esrc=s&source=web&cd=1&ved=0CCYQFjAA&url=http%3A%2F%2Fny.sun.gov%2F-%2Fmedia%2FNYSun%2Ffiles%2FMeetings%2F2014-11-06%2FSunShot-Solar-Industry-Update.pdf&ei=2DIDVf63OYSqNsCUhPAH&usq=AFQjCNFhnGZs41wmZP0ch3ZWQbBBcb35TA&si-g2=OHlsfbxx_fCXqyFMn5eZaw
- ⁹S. Gopinath. *Analysis: China Polysilicon Makers Buoyed by “Revenge” Import tax*. Reuters. (Jan 17, 2013). <http://www.reuters.com/article/2013/01/17/us-chinapolysiliconmakers-idUSBRE90G0JC20130117>
- ¹⁰J. Deutch and E. Steinfeld. *A Duel in the Sun: The Solar Photovoltaics Technology Conflict between China and the United States*. A Report of the MIT Future of Solar Energy Study. (May 15, 2013). <http://mitei.mit.edu/system/files/201305-futureofsolar-SunDuel.pdf>
- ¹¹*California Solar Statistics: Current CSI Data*. Go Solar California. http://californiasolarstatistics.ca.gov/current_data_files/
- ¹²M. Bolinger and S. Weaver. *Utility-Scale Solar 2013: An Empirical Analysis of Project Cost, Performance, and Pricing Trends in the United States*, Lawrence Berkeley National Laboratory. (Sep 2014). http://eetd.lbl.gov/sites/all/files/lbnl_utility-scale_solar_2013_report.pdf
- ¹³A. Ardani et al. *Non-Hardware (“Soft”) Cost-Reduction Roadmap for Residential and Small Commercial Solar Photovoltaics, 2013-2020*. National Renewable Energy Laboratory. Technical Report NREL.TP-7A40-50155. (Aug 2013). <http://www.nrel.gov/docs/fy13osti/59155.pdf>
- ¹⁴C. Davidson et al. (2014). *U.S. Residential Photovoltaic (PV) System Prices, Q4 2013 Benchmarks: Cash Purchase, Fair Market Value, and Prepaid Lease Transaction Prices*. National Renewable Energy Laboratory. Report No. TP-6A20-62671. <http://www.nrel.gov/docs/fy15osti/62671.pdf>
- ¹⁵Solar City Q2 2014 *Earnings Conference Call*. SolarCity Corporation. (Aug 7, 2014). http://files.shareholder.com/downloads/AMDA-14LQRE/3640139759x0x774881/0428314D-43A7-4ACD-916F-9EB054671C4E/SCTY_2Q14_Earnings_Presentation_Draft4.pdf
- ¹⁶J. Kassakian and R. Schmalensee. *The Future of the Electric Grid: An Interdisciplinary MIT Study*. Technical report, Massachusetts Institute of Technology. (2011). http://mitei.mit.edu/system/files/Electric_Grid_Full_Report.pdf
- ¹⁷*Solar Investment Tax Credit (ITC)*. The Solar Energy Industry Association. <http://www.seia.org/policy/finance-tax/solar-investment-tax-credit>
- ¹⁸U.S. *Internal Revenue Code: Section 25D*. U.S. Government Publication Office. (2011). <http://www.gpo.gov/fdsys/pkg/USCODE-2011-title26/pdf/USCODE-2011-title26-subtitleA-chap1-subchapA-partIV-subpartA-sec25D.pdf>
- ¹⁹U.S. *Internal Revenue Code: Section 48*. U.S. Government Publication Office. (2011). <http://www.gpo.gov/fdsys/pkg/USCODE-2011-title26/pdf/USCODE-2011-title26-subtitleA-chap1-subchapA-partIV-subpartE-sec48.pdf>

- ²⁰Private communication with Bloomberg New Energy Finance regarding the 2013 tax equity market.
- ²¹*Renewable Energy Project Finance in the U.S.: 2010-2013 Overview and Future Outlook*, Mintz Levin Greenpaper. (Jan 2012). <http://www.google.com/url?sa=t&rct=j&q=&esrc=s&source=web&cd=1&ved=0CCYQFjAA&url=http%3A%2F%2Fwww.mintz.com%2FDesktopModules%2FBring2mind%2FDMX%2FDownload.aspx%3FEntryId%3D231%26PortalId%3D0%26DownloadMethod%3Dattachment&ei=WJcEVdTQM4OZNqGChLAI&usg=AFQjCNEQ8QFiMHA6EXK93WRlxSURP47ZDg&sig2=a1q-FeB0h-IP0e2FXC1JDA>
- ²²*Primary Tax Equity Finance Structures Common to the U.S. Domestic Solar Energy Industry: June 2012*, The Reznick Group. http://apps.americanbar.org/dch/thedl.cfm?filename=/NR250100/sitesofinterest_files/reznick_white_paper.pdf
- ²³*SolarCity Corporation Form 10-K Annual Report, Fiscal Year Ended December 31, 2012*. U.S. Securities and Exchange Commission. <http://www.sec.gov/Archives/edgar/data/1408356/000119312513129655/d508901d10k.htm>
- ²⁴*Publication 561: Determining the Value of Donated Property*. U.S. Internal Revenue Service. (Apr 2007). <http://www.irs.gov/pub/irs-pdf/p561.pdf>
- ²⁵*Evaluating Cost Basis for Solar Photovoltaic Properties*. United States Department of Treasury, Office of the Fiscal Assistant Secretary in consultation with the Office of Tax Policy. http://www.treasury.gov/initiatives/recovery/Documents/N%20Evaluating_Cost_Basis_for_Solar_PV_Properties%20final.pdf
- ²⁶D. Feldman et al. *Photovoltaic System Pricing Trends: Historical, Recent and Near-Term Projections, 2014 Edition*. U.S. Department of Energy SunShot Program. (Sep 22, 2014). <http://www.nrel.gov/docs/fy14osti/62558.pdf>
- ²⁷H. Wirth. *Recent Facts about Photovoltaics in Germany*. Fraunhofer Institute. (Jan 7 2015). <http://www.ise.fraunhofer.de/en/publications/veroeffentlichungen-pdf-dateien-en/studien-und-konzeptpapiere/recent-facts-about-photovoltaics-in-germany.pdf>
- ²⁸J. Seel, G. Barbose, and R. Wiser. *Why Are Residential PV Prices in Germany So Much Lower than In the United States?* Lawrence Berkeley National Laboratory. (Feb 2013). <http://emp.lbl.gov/sites/all/files/german-us-pv-price-ppt.pdf>
- ²⁹M. Mendelsohn and D. Feldman. *Financing U.S. Renewable Energy Projects Through Public Capital Vehicles: Qualitative and Quantitative Benefit*. National Renewable Energy Laboratory, Technical Report NREL/TP-6A20-58315. (Apr 2013). <http://www.nrel.gov/docs/fy13osti/58315.pdf>
- ³⁰*Act No. 125: An Act Relating to Net Metering and Definitions of Capacity*. General Assembly of the State of Vermont. VT Leg 280789.1 (May 11, 2012). <http://www.leg.state.vt.us/DOCS/2012/ACTS/ACT125.PDF>
- ³¹B. Brooks. *Expedited Permit Process for PV Systems: A Standardized Process for Review of Small-Scale PV Systems*. Solar America Board for Codes and Standards. Revision 2. (Jul 2012). <http://www.solarabcs.org/about/publications/reports/expedited-permit/pdfs/Expermitprocess.pdf>
- ³²A. Metz et al. *International Technology Roadmap for Photovoltaic (ITRP) 2013 Results*. ITRPV. (2014). <http://www.itrpv.net/Reports/Downloads/2014/>

The hyperlinks in this document were active as of April 2015.

Chapter 5 – Economics of Solar Electricity Generation

In Chapter 4 we presented data on the total investment cost of residential- and utility-scale photovoltaic (PV) installations, and in Appendix D we presented data on the investment cost of utility-scale concentrated solar power (CSP) plants. In this chapter we first use those data, along with other information, to compute estimates of the cost of electricity generated at: (1) a 20-megawatt (MW) utility-scale solar PV project; (2) a 7-kilowatt (kW) residential rooftop PV installation, and (3) a 150-MW utility-scale CSP project. We consider hypothetical facilities at two U.S. locations for which reliable insolation data are available: the town of Daggett in southern California’s San Bernardino County and the city of Worcester in central Massachusetts.ⁱ The southern California location is much sunnier on average than the Massachusetts location: Daggett receives approximately 5.8 kilowatt-hours of solar radiation per square meter per day (kWh/m²/day) whereas Worcester receives approximately 3.8 kWh/m²/day. Together, this pair of sites helps illustrate the range of costs produced by geographic variation. We assume identical investment costs for the two locations, but account for differences in insolation and other location-specific factors discussed below. We then compare generation costs at these sites to each other and to the cost of electricity from

a new natural gas combined cycle plant with and without a carbon tax, where the carbon tax is set equal to the social cost of carbon dioxide (CO₂) emissions used by federal agencies in recent regulatory impact analyses.¹

Data on average hourly wholesale electricity prices in the two locations are used to shed light on the average value of power generated by our hypothetical solar installations, taking wholesale prices as given.ⁱⁱ We then look at the impact of a number of factors on the cost of solar electricity from our hypothetical facilities. To highlight the importance of balance-of-system (BOS) costs for PV installations, we compute generation costs assuming that module prices decline by 50%. And because, as we stress in Chapter 4, the residential PV market is immature, we present estimates of levelized cost assuming that residential BOS costs in the United States fall to a level commensurate with those in Germany. Finally, we analyze the effects of the main federal subsidies on generation costs in the United States. As discussed below, it was not possible for us to measure the effects of state-level policies (known as “renewable portfolio standards”) that oblige utilities in both California and Massachusetts to acquire a certain percentage of their electricity from renewable sources, or

ⁱOur insolation data are from the National Renewable Energy Laboratory (NREL), which provides hourly insolation data for individual years (1991–2010) and for the typical meteorological year for 1,454 locations in the United States through the National Solar Radiation Database. Insolation and local meteorological conditions are either directly measured at ground stations or modeled based on a combination of satellite and ground-based data. Here we select locations designated as Class I stations, which have a complete record of solar and meteorological data for all hours for 1991–2010 and the highest-quality modeled solar data. From this we constructed a series for the typical year.

ⁱⁱFor our southern California data, we used hourly day-ahead locational marginal prices from the California Independent System Operator (CAISO) for the two major transmission intersections closest to Daggett, and averaged them. We are indebted to Gavin McCormick and Anna Schneider at WattTime for providing this data. For our central Massachusetts data, we used Independent System Operator-New England (ISO-NE) hourly day-ahead locational marginal prices for West-Central Massachusetts, made available in convenient form by GDF SUEZ Energy Resources.² In both cases, we constructed a series for a typical year by averaging over the years 2010–2012.

the effects of an array of additional state- and local-level renewable energy policies in these and other states.

Before turning to the details and results of our quantitative analysis, it is useful to begin with a general discussion of how the cost and value of electricity from particular generating facilities can be measured.

5.1 MEASURING THE COST AND VALUE OF SOLAR ELECTRICITY

A metric that is widely used to compare alternative generating technologies is the levelized cost of electricity (LCOE).ⁱⁱⁱ Given a stream of capital and operating costs incurred over the life of a facility and a corresponding stream of electricity production, the LCOE is defined as the charge per kWh that implies the

One important limitation is that the LCOE implicitly values all kilowatt-hours of power produced the same, regardless of when they are generated. But the incremental cost of meeting electricity demand is higher during peak periods.

same discounted present value as the stream of costs. The discounting is done using a cost of capital appropriate to the type of project being considered. Put another way, the LCOE is the minimum price a generator would have to receive for every kWh of electricity output in order to cover the costs of producing this power, including the minimum profit required on the generator's investment. More detail on the calculation of LCOE is presented in Appendix E.

Renewable electricity generated in peak hours is more valuable than electricity generated in off-peak hours.

The Cost of Capital

A critical component of the LCOE is the cost of capital. As described in detail in Appendix E, our basic analysis assumes a weighted average nominal cost of debt and equity capital of approximately 6.67%, along with an expected inflation rate of 2.5%.^{iv} A 6.67% nominal cost of capital may seem high, given the extremely low interest rates that prevailed as this report went to press, but it is likely to be quite reasonable in more normal times.

Value versus Levelized Cost

Estimating the LCOE is only a starting point for evaluating the economics of a solar project, or of any other power generation project. One important limitation is that the LCOE implicitly values all kilowatt-hours of power the same, regardless of when they are generated. But the incremental cost of meeting electricity demand is higher during peak periods, like hot summer afternoons, than during off-peak periods, like comfortable spring evenings. During peak periods, incremental demand is typically met by employing fossil-fuel generating units that are operated for only a few hours a year. Since it is expensive to keep large amounts of capital idle most of the time, these units generally have low capital costs and, as a consequence, relatively high marginal costs. Thus renewable electricity generated in peak hours is more valuable than electricity generated in off-peak hours because it permits a larger reduction in fossil generation costs at the margin. In competitive wholesale power markets, this fact is at least partially reflected in higher prices for electricity during peak hours as compared to prices during off-peak hours. The price of electricity also varies over the course of the calendar year for

ⁱⁱⁱSee, for example, NREL.^{3,4}

^{iv}Background on the weighted average cost of capital can be found in, for example, Brealey, Myers, and Allen.⁵

similar reasons. Other limitations of the LCOE arise when this metric fails to reflect a project's ability to provide capacity to meet uncertain demand, its ability to provide ramping capability, and other distinguishing attributes, some of which are discussed in more detail in Chapter 8.

To keep our analysis simple and because the value of the time profile of generation is so critical for a non-dispatchable resource like solar, we address only the average-price limitation of the LCOE.^v Specifically, we use the time profile of wholesale electricity prices as the best available measure of the time profile of the social value of power. If more solar generation occurs when the hourly location-specific price is above average than when the price is below average, solar generation is more valuable per kWh than baseload generation. In this case, a solar plant selling at hourly location-specific prices would be viable at a lower unweighted average price than a baseload power plant with the same LCOE.^{vi} Hirth introduced the term “*value factor*” to denote the ratio of a facility's output-weighted average price to its corresponding unweighted average price.¹²

Dividing a facility's LCOE by its value factor produces what we call the *value-adjusted* LCOE — in other words, it gives the minimum unweighted average price per kWh that would cover the generator's cost, given the observed temporal pattern of prices.

At least at low levels of solar penetration, one would expect solar facilities to have value factors above one, since wholesale prices tend to be higher in the day than at night. For our hypothetical PV facilities, we computed value factors using the typical-year insolation data described in Footnote i and the typical-year hourly price data described in Footnote ii. The value ratio for the southern California location was 1.13 and for the central Massachusetts location was 1.10. These values are roughly consistent with results obtained by Schmalensee (forthcoming)¹³ using 2011 data.^{vii} For the CSP facilities, without taking advantage of energy storage, the value ratio for the southern California location was 1.08; for central Massachusetts it was 1.11. This differs from the value ratio for our hypothetical PV project primarily because a certain amount of

^vThe U.S. Energy Information Administration (EIA) recently introduced another metric, the levelized avoided cost of energy (LACE) that can be used along with the LCOE to address this same limitation. See the presentation by Chris Namovicz.⁶ See also two papers available at the same website.^{7,8} LACE is closely related to the value factor defined below, except that it includes capacity payments available through wholesale markets. The Minnesota Department of Commerce, Division of Energy Resources recently undertook an alternative, similarly inspired effort to augment the LCOE.⁹

For a recent, much more ambitious — and controversial — attempt to quantify all the costs and benefits of a set of generating technologies that includes solar PV, see Charles R. Frank, Jr.¹⁰ and Amory Lovins.¹¹

^{vi}Output from solar facilities is often sold under fixed-price, long-term contracts, not on the day-ahead hourly market. Absent a subsidy, however, one would not expect a buyer to pay more under a long-term contract than the (discounted) expected value of future hourly prices, since the buyer is bearing all the price risk. Indeed, many solar power purchase agreements adjust payments according to the hours in which power is actually delivered, specifying a higher price for power in some hours than in others. In any case, the value of a solar facility's output will surely influence the price it will command in the market.

^{vii}An earlier version is Schmalensee's 2011 value factors, which are calculated for nine PV facilities, three of which were at unknown locations in California and three of which were at unknown locations in New England.¹⁴ All nine solar value factors were above one. (In contrast, 22 of 25 value factors for wind generators were below one.) Value factors for the three California PV plants clustered tightly around the average of 1.13, which is exactly the value factor we find here for our southern California location at Daggett. For the three New England plants, Schmalensee found value factors of 1.18, 1.11, and 1.08, for a combined average of 1.12. This is higher than the 1.10 value factor we find here for our central Massachusetts location at Worcester, but well within the range of the data.

within-day inertia in the timing of electricity production is inherent in CSP, since the temperature of the medium that stores solar-derived thermal energy is relatively insensitive to short-term fluctuations in insolation.

In a system with lots of solar generators that can profitably sell power in the short run at almost any positive price, wholesale prices might be lower at noon than at midnight.

However, taking optimal advantage of energy storage opportunities that would allow a CSP facility to accumulate thermal energy during hours of low electricity prices and generate at maximum capacity during hours of high electricity prices (so long as either insolation or stored thermal energy is available), the value ratios for the hypothetical CSP facilities increase to 1.12 and 1.16 at the southern California and central Massachusetts locations

respectively. We use these higher values to calculate a value-adjusted LCOE for the CSP facilities.

Unfortunately, the value factor for any solar project is likely to decline dramatically with increased penetration of solar generation in the overall power mix as a result of basic supply and demand dynamics. Simply put, increasing the amount of zero-marginal-cost generation available during hours of high insolation will drive the price down in those hours. In a system with lots of solar generators that can profitably sell power in the short run at almost any positive price, wholesale prices might be lower at noon than at midnight.

Hirth finds considerable evidence for declining value factors in European data over several years of increasing solar penetration.¹² Figure 5.1, taken from Hirth, shows how the daily electricity price structure in Germany

Figure 5.1 Summertime Hourly Electricity Wholesale Prices Relative to Seasonal Average Price in Germany 2006–2012

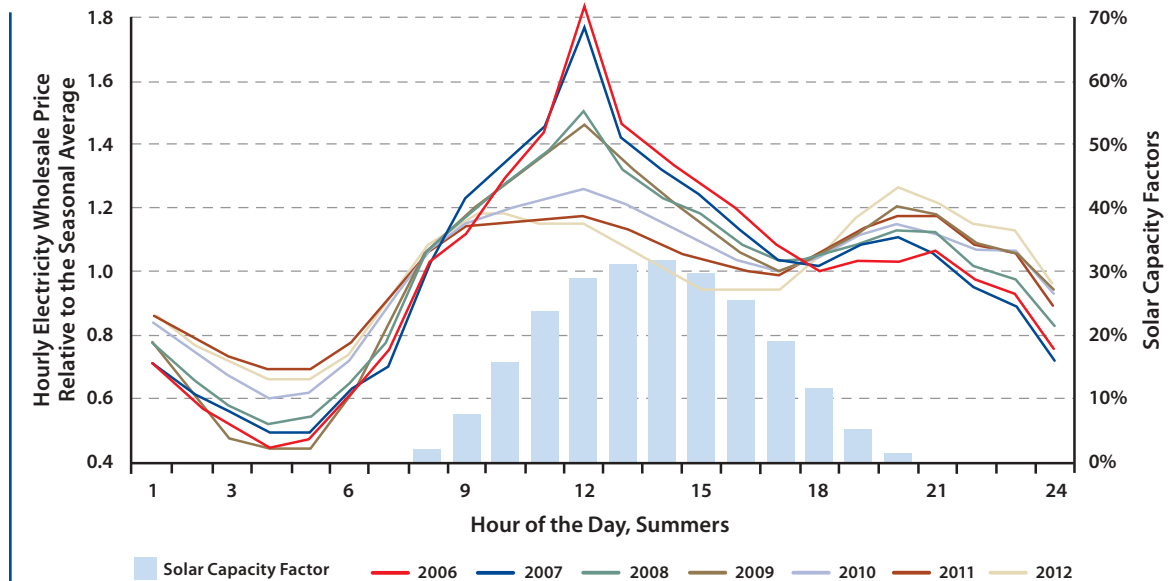

Note: Lines show hourly wholesale prices relative to the seasonal average price for different years for the period 2006–2012, a time when installed solar capacity in Germany increased by 30 GW. The bars show the time profile of solar generation in Germany measured as the capacity factor for installed generation for 2006 to 2012.¹²

Copyright © 2013, Elsevier, B.V. All rights reserved.

Figure 5.2 Value Ratio for Solar Generation in Germany with Changing Market Share¹²

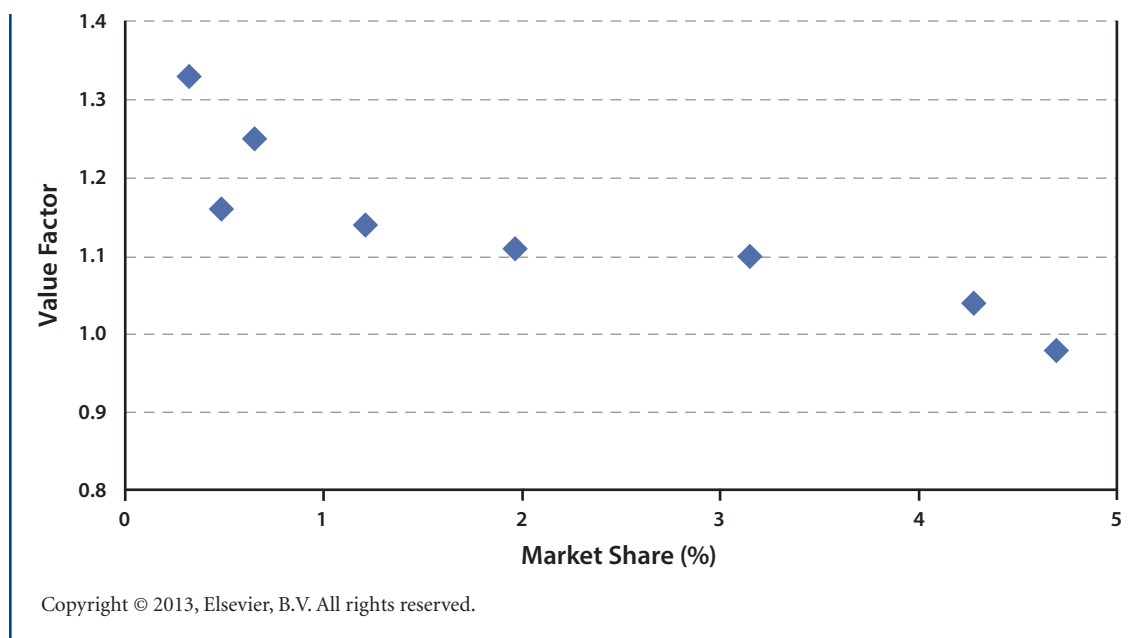

during summer hours changed between 2006 and 2012 as solar capacity increased by 30 gigawatts (GW). In 2006, the price at noon was 80% higher than the average price, while in 2012 it was only about 15% higher. Consequently, the value ratio for solar power declined dramatically over the same time. Figure 5.2, also taken from Hirth, shows this decline as a function of solar generation’s increasing market share. It follows that currently observed value factors provide only a rough upper bound to expected future value factors for intermittent generators in the same market, using the same technology.

5.2 UTILITY-SCALE PV

Our analysis begins with the solar electricity generating technology that enjoys the most favorable economics today. As noted above,

we consider hypothetical solar PV plants in California and Massachusetts with a nameplate direct current (dc) peak power rating of 20 MW.^{viii} The project life is assumed to be 25 years, with output from the modules degrading at a rate of 1% per year, so that output in the 25th year equals approximately 79% of output in the first year.

Following Chapter 4, we assume a fully loaded module cost (i.e., including associated installer overhead) of 65 cents per watt (\$0.65/W), which — when multiplied to reflect a 20 MW, utility-scale facility — yields an up-front investment cost of \$13 million for the modules. Besides the cost of the modules, the complete installation requires the purchase of inverters, brackets, and wiring, as well as additional expenditures on engineering, construction and project management, sales taxes on materials,

^{viii}These projects are assumed to be ground-mounted, fixed-tilt arrays using multicrystalline silicon PV modules with a dc peak power of 310W and a power conversion efficiency of 16%. The direct-current-to-alternating-current (dc-to-ac) derate factor of approximately 0.86 was estimated following NREL. The total dc-to-ac derate factor of 0.86 includes inverter and transformer inefficiencies (0.977), module-to-module mismatch (0.980), blocking diode and connection losses (0.995), dc wiring losses (0.980), ac wiring losses (0.990), soiling loss (0.950), and system downtime (0.980). We do not include losses due to nameplate rating error, shading effects, and tracking error. For further discussion, see NREL.¹⁵

and other charges. Together these are known as BOS (balance-of-system) costs. Again following Chapter 4, we assume a BOS cost of \$1.15/W. At the 20 MW scale, this yields an additional up-front investment cost of \$23 million. Together, the module and BOS costs add to a total investment of \$36 million. Module cost and BOS costs account for 36% and 64%, respectively, of this total.

A given project may also incur additional indirect costs associated with grid integration. These indirect costs depend on many factors.

After the initial investment, our hypothetical project incurs annual operation and maintenance (O&M) costs, which we assume equal \$0.02/W per year.¹⁶ We assume O&M costs escalate with inflation. So, in the first year of operation, the O&M cost is \$410,000. In addition, the project's inverters will need to be replaced in the twelfth year of operation at a cost of \$3 million (before accounting for inflation).

Investment cost plus O&M costs constitute all direct costs. However, a given project may also incur additional indirect costs associated with grid integration. These indirect costs depend on many factors, including the institutional rules governing the region where the project is located. For example, the intermittency of the solar resource may force the grid manager to maintain additional flexible resources to ensure system reliability, and some of these costs might be imposed on the solar facility.^{ix} In addition, depending on the location of the project and applicable cost allocation rules, there may be costs associated with installing a transmission line to deliver power from the solar facility to the existing grid. Our calculations do not include any charges for these or any other indirect costs.

We apply the same investment cost and O&M cost assumptions to both the southern California and the central Massachusetts plants. Given the typical insolation at our southern California location, this plant should generate approximately 36,000 megawatt-hours (MWh) of electricity in the first year of operation, with output in subsequent years declining gradually over the life of the project. In contrast, lower levels of insolation at the central Massachusetts location mean that the same plant can be expected to generate approximately 24,000 MWh in its first year of operation, one-third less electricity than the southern California project using the same equipment. Because of this difference in output, the LCOE of the central Massachusetts project is 15.8 cents per kilowatt-hour (¢/kWh), 50% higher than the 10.5¢/kWh LCOE of the southern California project. These figures assume no subsidies. Figure 5.3 provides a convenient visual display of these LCOEs, together with some of the further results discussed below. These results are also summarized in Table 5.1, which appears at the end of the chapter.

As described above, we calculated value factors for the California and Massachusetts locations to account for the fact that peak solar output is likely to occur at times when demand is high and prices for electricity are above average. Dividing by these value factors lowers the LCOE of the southern California project by 12% and lowers the LCOE of the central Massachusetts project by 9% (see Table 5.1). As we noted previously, value factors will tend to decline as the share of solar energy in the overall generation mix increases. This in turn would raise the value-adjusted LCOEs of future solar projects. At a certain level of penetration, value factors for solar generators are likely to decline below 1, so that the value-adjusted LCOE rises above the unadjusted LCOE.

^{ix}See Chapter 8 of this report and Gowrisankaran, Reynolds, and Samano.¹⁷

One way to evaluate these LCOEs for utility-scale PV is to compare them against the LCOEs for competing technologies. Currently, the most prominent competitor for investment in new electricity-generating capacity is natural gas combined cycle (NGCC) technology. The U.S. Energy Information Administration (EIA) estimates the LCOE of new NGCC plants at 6.66¢/kWh, less than two-thirds the estimated LCOE for our hypothetical California project.^x

This figure does not take into account any spillover costs associated with the NGCC plant's CO₂ emissions, however. Adding a charge of \$38 per metric ton of CO₂, consistent with the "social cost of carbon" used in recent federal-level regulatory analyses, increases the LCOE for the natural gas plant by 1.42¢/kWh, bringing its total LCOE to 8.08¢/kWh — still well below the estimated LCOE for our two solar projects.^{xi} Figure 5.3 places this benchmark against the LCOEs for utility-scale PV. In order for the LCOE of the utility-scale PV project to be equal to the LCOE of natural gas fired generation, the CO₂ charge would have to rise to \$104 per ton.

To explore the importance of BOS costs, we recalculate the LCOE for our two PV projects assuming that the module cost is reduced by

In order for the LCOE of the utility-scale PV project to be equal to the LCOE of natural gas fired generation, the CO₂ charge would have to rise to \$104 per ton.

50%. This change reduces the LCOE for the southern California and central Massachusetts projects to 8.9¢/kWh and 13.4¢/kWh, respectively. These results are included in Table 5.1. Thus, even in a scenario that assumes a 50% reduction in module cost, a carbon tax consistent with the federal government's estimate of the damages caused by CO₂ emissions, and a value factor that is not depressed by high levels of solar penetration, utility-scale PV would be competitive with NGCC in southern California, but not in central Massachusetts. Clearly reductions in BOS cost could make an enormous difference to the LCOE for PV generators.

^xThis is EIA Levelized Cost of New Generation Resources.¹⁸ Table 5.1 gives a total cost inclusive of transmission equal to 6.63¢/kWh in 2012\$ for plants entering service in 2019. We subtract the transmission cost to arrive at a busbar cost, and then we escalate the figure to 2014\$ using the Bureau of Economic Analysis (BEA) price index for GDP, gross private domestic investment, fixed investment, non-residential. As discussed in Appendix E, our estimates of LCOE should be comparable to those calculated by the EIA, given identical inputs such as the cost of equipment and the price of fuel. We use a slightly lower cost of capital, which, if it were applied to the other EIA inputs would slightly decrease EIA's calculated LCOE for the NGCC plant. The EIA also reports an LCOE of 12.88¢/kWh for utility-scale solar PV, excluding transmission cost and escalated to 2014\$. This figure falls between our two estimates reported above.

The OpenEI database¹⁹ sponsored by the U.S. Department of Energy, NREL, and a number of private firms reports a median LCOE for combined cycle gas turbine (CCGT) plants of 5¢/kWh.

The California Energy Commission (CEC) reports a mid-range estimated LCOE for NGCC of 15.76¢/kWh. This figure assumes a typical capacity factor of 57%, whereas the EIA figure assumes a high, baseload capacity factor of 87%. Applying the higher capacity factor to CEC's other assumptions would reduce CEC's calculated LCOE by one-third, to just over 10¢/kWh.

^{xi}Based on the NGCC plant emitting 53.06 million metric tons of CO₂ per quadrillion Btus, and on a heat rate of 7.050 Btu/kWh, as per the EIA.²⁰ An interagency working group of the U.S. government produces estimates of the social cost of carbon under a range of assumptions; see Footnote ii above for the publication. Looking at their central case (3% discount rate), they report figures starting at \$32 per ton CO₂ and increasing to \$71 per ton CO₂ in 2050, all denominated in 2007 dollars. If we take the \$36-per-ton figure for 2014 and translate it from 2007\$ into 2014\$ to match our other data using the BEA price index for GDP, gross domestic product, we get the \$38-per-ton-CO₂ figure used in this analysis.

FINDING

At current and expected natural gas prices, using solar energy to generate electricity at most locations in the United States is considerably more expensive than using natural gas combined cycle technology, even if natural gas plants are subject to a carbon tax equal to the “social cost of carbon,” as determined by the U.S. government, and even giving credit for the current value of solar electricity. Under these conditions, a further 50% reduction in module costs would make utility-scale PV competitive in California, but not in Massachusetts.

5.3 RESIDENTIAL-SCALE PV

To explore the economics of residential-scale PV, we consider hypothetical rooftop installations in our southern California and central Massachusetts locations with a nameplate DC peak power rating of 7 kW.^{xii}

Following Chapter 4, we assume a module cost of \$0.65/W and a BOS cost of \$2.60/W. This yields a total up-front investment cost of \$22,750 for a 7 kW installation, of which \$4,550 (20%) consists of module costs and \$18,200 (80%) consists of BOS costs.

After the initial investment, we assume annual O&M costs start at \$0.02/W per year and escalate with inflation. This means O&M costs in the first year of operation total \$144 and rise with inflation thereafter. In addition, we assume

that inverters will need to be replaced in the twelfth year of operation at a cost of approximately \$2,030 before adjusting for inflation.

As with our analysis of utility-scale projects, indirect costs — such as costs for the flexible reserve capacity needed to accommodate intermittent generation or for reinforcements of the local distribution network to handle power flows from solar-generating residential customers back to the grid (discussed in Chapter 7) — are not included here.

We apply the same capital cost assumptions to both the southern California and central Massachusetts projects. Given typical insolation, the southern California rooftop installation should generate approximately 11.9 MWh in the first year of operation, with output declining gradually thereafter over the life of the project. In contrast, the same installation in central Massachusetts should generate approximately 7.9 MWh of power in its first year of operation. This is one-third less than the southern California project and is due to lower insolation in the Massachusetts location. Reflecting this difference in output, the LCOE for the central Massachusetts project is 28.7¢/kWh, 50% higher than the LCOE for the southern California project at 19.2¢/kWh. These values are shown in Figure 5.3 and appear in Table 5.1.

As we noted in Chapter 4, residential BOS costs in the United States are much higher than in Germany. Some of this difference reflects the relative immaturity of the U.S. residential PV market; some reflects the effect of local rather than national policies on issues such as

^{xii}We assume roof-mounted, fixed-tilt arrays using multicrystalline silicon PV modules with a dc peak power of 310 W and a power conversion efficiency of 16%. A dc-to-ac derate factor of approximately 0.81 was estimated, although a reduced inverter/transformer efficiency is assumed. The total dc-to-ac derate factor of 0.81 includes inverter and transformer inefficiencies (0.920), module-to-module mismatch (0.980), blocking diode and connection losses (0.995), dc wiring losses (0.980), ac wiring losses (0.990), soiling loss (0.950), and system downtime (0.980). We do not include losses due to nameplate rating error, shading effects, non-optimal roof alignment, or tracking error. See NREL for further discussion.¹⁵

permitting processes and interconnection standards. To reflect the possibility that residential BOS costs in the United States could be substantially reduced over time, we recalculate the LCOE using a BOS cost of \$1.34/W — nearly 50% lower than the \$2.60/W BOS cost assumed in our base case. With this reduction in BOS costs, the LCOE for a 7 kW rooftop PV installation would fall to 12.0¢/kWh and 18.0¢/kWh in California and Massachusetts, respectively. These figures, which are included in Table 5.1, assume no subsidies.

FINDING

Utility-scale PV is likely to remain much less expensive than residential-scale PV, even in the face of foreseeable reductions in the balance-of-system costs associated with residential-scale PV.

Even in the absence of explicit subsidies, for most homeowners the relevant comparison is not between the LCOE of residential PV and the LCOE of other generation technologies, or between the LCOE of residential PV and the wholesale price of electricity. Rather the relevant comparison for most homeowners is to the retail price of electricity delivered over the grid. This retail price typically contains a number of additions on top of the wholesale price, including charges to cover the costs of the transmission and distribution systems. These transmission and distribution costs, though they do not vary with the level of electricity consumed (except when new construction is required), are overwhelmingly recovered from customers in the United States through a per-kWh charge. Because retail prices per kWh, which include these charges, exceed wholesale prices — often by a substantial margin — it is possible for a residential PV system to make economic sense for a homeowner even if its levelized cost for electricity is well above the wholesale price paid to utility-scale generators.

Moreover, in some cases, the per-kWh rate for residential customers increases with total consumption, so that heavier users face a higher rate — a higher marginal cost. In some locations, the highest rates charged to retail customers can make residential PV economically competitive, even at current LCOEs. In other locations, anticipated cost reductions in coming years will make residential PV systems competitive for high marginal rate customers, assuming that the rate structure remains as it is today. For example, the highest marginal rates currently charged by California's three major distribution utilities range from 21.8¢/kWh to 35.9¢/kWh, while the highest marginal rate for retail customers in Oahu, Hawaii, is 24.7¢/kWh.^{21,22,23,24}

Net metering pays distributed generators a much higher price for power than grid-scale generators receive.

The difference between wholesale and retail costs of power is central to the growing debate about net metering regulations and about the broader question of tariff rules for transmission and distribution charges. A net metering system charges the homeowner for the net quantity of electricity consumed — in other words, total consumption less total generation. This means, in effect, that the utility is paying for electricity generated by the homeowner at the retail rate, in contrast to utility-scale generation facilities, which receive the wholesale price. Because the retail rate includes charges for the cost of the transmission and distribution system (on top of a charge for the power consumed), net metering pays distributed generators a much higher price for power than grid-scale generators receive. As discussed in the MIT

Because retail prices per kWh exceed wholesale prices, it is possible for a residential PV system to make economic sense for a homeowner even if its levelized cost for electricity is well above the wholesale price paid to utility-scale generators.

CSP plants can be designed to allow operators to delay the use of thermal energy from the solar field by redirecting it to a storage system.

Future of the Electric Grid study,²⁵ “net metering policies provide an implicit subsidy to all forms of distributed generation that is not given to grid-scale generators.” Chapter 7 of this report provides a more detailed analysis of the impact of distributed solar generation on the costs of the transmission and distribution system.

5.4 UTILITY-SCALE CSP

This section discusses the economics of two hypothetical utility-scale CSP plants using the same southern California and central Massachusetts locations described in the previous sections. Both plants employ the Power Tower technology described in Chapter 3 and are designed to have a nominal net generation capacity of 150 MW.^{xiii} The System Advisor Model (SAM) developed by the U.S. Department of Energy’s National Renewable Energy Laboratory (NREL) is used to simulate the operation of the CSP plants.²⁶ More information regarding the design of the CSP plants is provided in Appendix D.

To account for output interruptions, we apply a system availability factor of 96%. Because of the nature of CSP plants, however, production capacity is not expected to decline over time as would be the case for PV plants. Our assumptions for CSP capital and operating costs are based on existing engineering estimates available in the literature.^{27,28} We then adjust these cost estimates to reflect the size of our hypothetical plants using common engineering practices and convert to

2014 dollars using the Chemical Engineering Plant Cost Index.²⁹ Appendix D provides further detail regarding the technical specifications and cost assumptions used in our analysis.

CSP plants can be designed to allow operators to delay the use of thermal energy from the solar field by redirecting it to a storage system (see Chapter 3). This makes it possible to deliver a more even stream of energy over time to the facility’s power generation components, raising their capacity factor and allowing for a lower LCOE. Energy storage capability can also make it possible to delay power generation to periods later in the day when electricity prices are higher. This raises both the capacity factor and the facility’s value factor. The cost of energy storage includes the cost of storage tanks and pumps, as well as costs associated with having a larger solar field capable of providing energy to both power generation and storage systems.

The CSP plant designs considered in this chapter are optimized to minimize their LCOEs. Our hypothetical plants in southern California and central Massachusetts have 11 and 8 hours of storage, respectively — measured assuming operation at full load. This difference mainly reflects the higher insolation of the California location, which makes it cheaper to produce thermal energy for storage, as well as for generation. Obviously, however, the typical daily pattern of prices will affect the value of storage.

For the southern California plant, we estimate the LCOE (with no subsidies) at 14.1¢/kWh. For the central Massachusetts plant, we estimate the no-subsidy LCOE at 33.1¢/kWh, or

^{xiii}In both plants, circular arrays of heliostats reflect and focus the sunlight onto the top of the tower where an External Receiver accepts the reflected sunlight and transfers the thermal energy to a Heat Transfer Fluid (HTF). A mixture of 60% NaNO₃ and 40% KNO₃ is used as the HTF. The size of the solar field and the tower dimensions are optimized to the satisfaction of plant requirements. No fossil boiler (neither backup nor supplemental) is considered for the plants. In addition, to minimize water requirements, an air-cooled steam condenser is assumed for both plants. To improve the economics of the plants, a two-tank thermal energy storage (TES) system is considered for each plant. The size of the storage system is optimized to minimize the LCOE of the plant. Other technical specifications of the plants follow those suggested by the engineering firm WorleyParsons and are used as default values in SAM.

more than double the cost of power using the same technology optimized for the southern California location. These results are displayed in Figure 5.3 and included in Table 5.1. The difference in LCOE for the two locations is more dramatic in the CSP case than in the utility-scale PV case because of a greater difference in direct insolation (relative to total insolation) between the two sites. As noted in Chapter 3, CSP plants can only make use of direct insolation, which is lower as a fraction of total insolation in central Massachusetts due to a greater abundance of clouds.

Dividing by value factors that incorporate the potential to delay generation using the CSP plants' thermal storage capability produces a value-adjusted LCOE at the southern California project that is 12.6¢/kWh (or 11% less than the baseline value); the value-adjusted LCOE at the central Massachusetts project is 29.5¢/kWh (also 11% less than the baseline value), as shown in Table 5.1. At higher levels of solar penetration, the value factors for CSP plants will decline, but because of the flexibility provided by storage, this decline should be less steep than for PV plants.

FINDING

Currently CSP generation is slightly more expensive than utility-scale PV in regions like California that have good direct insolation. It is much more expensive, however, in cloudy or hazy areas that experience relatively little direct solar irradiance, like Massachusetts. Adding energy storage and optimally deploying this capability reduces the LCOE of CSP plants and enables CSP generators to focus production on periods when electricity is most valuable.

5.5 SUBSIDIES

A wide range of subsidies has been used in recent years to encourage the deployment of solar generation technologies in the United States. The federal government has provided many of these subsidies, while state and local governments have provided many others.^{xiv}

A wide range of subsidies has been used in recent years to encourage the deployment of solar generation technologies in the United States.

Federal Tax Preferences

Currently the U.S. government offers two important tax preferences at the federal level: an investment tax credit (ITC) and an accelerated depreciation schedule, for tax purposes, for solar energy projects. Specifically, such projects can use a 5-year Modified Accelerated Cost Recovery System (MACRS) schedule instead of the 15-year schedule that is applied to other generation technologies with similar lives.

Over the last several decades, solar power generation has often qualified for an investment tax credit of one sort or another. The Energy Policy Act of 2005 increased the ITC from 10% of the qualifying cost of a project to 30% through 2007. In 2008, the Emergency Economic Stabilization Act extended the 30% ITC through 2016. Absent new legislation, the credit reverts back to 10% in 2017. Under the current ITC, 30% of the cost of a solar installation can be taken as a credit against taxes owed. The developer must then reduce the depreciable basis of the installation. Under current regulations, the basis is reduced by one-half of the credit — thus, the depreciable basis is 85% of the investment cost.

^{xiv}These subsidies are discussed in more detail and evaluated in Chapter 9 of this report. A complete list of references is available at DSIRE, a website maintained by North Carolina State University for the U.S. Department of Energy.³⁰

The Tax Reform Act of 1986 established current MACRS depreciation schedules and specified the use of a 5-year schedule for solar, geothermal, and wind generation facilities. The accelerated depreciation reduces a project's taxable income in the first five years, while increasing its taxable income in the sixth to sixteenth years of operation. Although the project's total taxable income over all years remains the same, an accelerated depreciation schedule has the effect of pushing tax payments out into later years when the same dollar has a lower present value. This lowers the project's LCOE.

As noted in Chapter 4, subsidies in the form of tax credits can sometimes only be used efficiently by a small subset of corporate entities that have substantial taxable profits. This subset does not include most developers of solar projects. Instead, to tap these subsidies solar developers often have to contract with entities that can efficiently use the ITC in what is loosely called the “informal, over-the-counter” tax equity market. Depending on the state of that market, a solar developer may have to pay a hefty share of the value of the ITC to the tax equity partner. This leaves less to the solar developer and reduces the effectiveness of the subsidy: less solar technology deployment is supported per dollar of subsidy cost to taxpayers. The share of value captured by the tax equity market creates a wedge between the value and the cost of the tax subsidy. By reducing the effective value of every dollar of subsidy it increases the cost (to taxpayers) of achieving the purpose of the subsidy.

It is difficult to pin down the size of this wedge in the case of a subsidy like the federal ITC. One recent study concluded that renewable energy developers captured only 50% of the value of the ITC, implying that a direct cash subsidy could support the same level of deployment at half the cost of the current tax credit subsidy.³¹

One recent study concluded that renewable energy developers captured only 50% of the value of the ITC.

The state of the U.S. economy plays a strong role in determining the size of the wedge. For example, the financial crisis of 2008 and the ensuing recession so dramatically reduced the available pool of tax equity financing that the ITC was widely viewed as completely ineffective. This motivated the temporary creation of a cash grant option in lieu of the ITC as a part of the Obama Administration's economic stimulus legislation, the American Recovery and Reinvestment Act of 2009. While the tax equity market has at least partially recovered in recent years, there still remains a significant wedge between cost and value.

Assuming developers capture 50% of the federal ITC subsidy, the LCOE for the hypothetical, southern California utility-scale PV project analyzed in this chapter is 8.4¢/kWh. In that case, existing federal tax preferences have lowered the LCOE by 2.1¢/kWh or 20%. For our central Massachusetts utility-scale PV project, the LCOE — again assuming developers capture 50% of the federal ITC subsidy — is 12.7¢/kWh. In that case, tax preferences have lowered the LCOE by 3.1¢/kWh (likewise 20%). For our residential PV and utility-scale CSP examples, current federal tax preferences lower

the LCOE by 21%.^{xv} These values are displayed in Figure 5.3 and in Table 5.1. If, somehow, the federal ITC subsidy were 100% effective, it would lower these LCOEs further still, as displayed in Table 5.1: for our southern California utility-scale PV project, the LCOE would fall to 6.8¢/kWh; for our central Massachusetts utility-scale PV project, the LCOE would fall to 10.1¢/kWh; for our southern California residential-scale PV project, the LCOE would fall to 12.0¢/kWh; for our central Massachusetts residential-scale PV project, the LCOE would fall to 18.0¢/kWh; for our southern California CSP project, the LCOE would fall to 10.2¢/kWh; and for our central Massachusetts CSP project, the LCOE would fall to 23.9¢/kWh.

State and Local Incentives — Renewable Portfolio Standards

Individual state and local governments employ a wide array of tools to encourage the deployment of various renewable generation technologies.³⁰ These tools include direct cash incentives, net metering policies, tax credits and tax incentives, loan programs and favored financing arrangements, programs to facilitate permitting and other regulatory requirements,

and many others. Both California and Massachusetts provide cash payments to solar generators; in California these payments start at 39¢/kWh for large PV facilities. Along with 41 other states and the District of Columbia, California and Massachusetts have also implemented net metering policies. These compensate residential PV generation at the retail price of power, which is often a significant multiple of the wholesale price at which utility-scale generators are compensated and thus provide a differential subsidy to residential PV. For instance, during 2013, the retail rates of Pacific Gas and Electric, which serves the Bay Area in northern California ranged up to 36¢/kWh,²³ while the weighted average wholesale price of electricity at the northern California hub of the California Independent System Operator (CAISO) averaged 4.4¢/kWh.^{xvi} Finally, both California and Massachusetts exempt solar generation equipment from sales and property taxes, and both have a variety of other programs in place to support deployment of solar (and other renewable) generation. Even if the analysis were confined to just one or two states, it would be an enormous task to measure the impact of all the renewable energy support policies in effect at any particular time.

^{xv}While the costs of the tax equity market lower the subsidy value captured by the developer, other factors may raise it. In particular, developers of residential solar installations must estimate the fair market value (i.e., the basis) for the purpose of calculating the ITC, and some analysts have claimed that the reported basis is often too high. One published estimate³² puts the premium of the reported to actual cost in the neighborhood of 10%. This is comparable to a 10% increase in the value of the subsidy.

^{xvi}This was computed as the average of the weighted average prices reported by EIA for hub NP-15.³³ Net metering is discussed further in Chapter 9 of this report.

Currently 29 states, including California and Massachusetts, and the District of Columbia have RPS programs.

One widely employed support policy is the renewable portfolio standard (RPS), which requires retail providers of electricity, generally called load-serving entities (LSEs) to generate or purchase a minimum fraction of their electricity from renewable sources.^{xvii} Currently 29 states, including California and Massachusetts, and the District of Columbia have RPS programs. Solar generation can be used to satisfy the RPS obligation in all these jurisdictions, and 17 of the 30 programs currently in place have additional provisions that specifically favor solar electricity. For example, some states, including Massachusetts, have specific quantitative requirements for solar generation.

Renewable energy credit (REC) prices ranged between essentially zero and 6¢/kWh in recent years, while solar REC prices have been as high as 65¢/kWh.

A common design feature of current state programs, which has been implemented in Massachusetts and (with restrictions) in California, involves tradable renewable energy credits (RECs). Whenever a certified renewable generator produces a MWh of electric energy, the generator also produces a REC. Often the REC is bundled with the electricity and sold under a long-term contract to an LSE. However, many states allow RECs to be sold separately, so that renewable generators are paid both for the RECs they produce as well as for the electricity they generate, which is usually sold on the wholesale market. The LSE then meets its

obligation by turning over the required number of RECs to the agency administering the program. The value of the REC is thus an additional per-MWh subsidy to renewable generators — one that is paid by consumers of electricity rather than by taxpayers (as is the case with the ITC and accelerated depreciation). When there is a specific requirement for solar generation, the corresponding RECs are called solar RECs (SRECs). SRECs are typically more valuable (and hence more expensive for LSEs to purchase) than RECs produced by other renewable generation technologies.

In part because most RECs and SRECs are currently being sold under long-term contracts, REC and SREC markets are thin and data on prices are scarce. We do know that state-level RPS policies vary enormously in stringency and on other dimensions, and the available price data mirror this variation. In addition, REC and SREC prices vary substantially over time: they tend to be close to zero when the corresponding regulatory constraint is not binding and can be very high when there is simply not enough renewable capacity available to meet state requirements. A recent NREL survey (2014) provides some data on REC and SREC prices, showing that REC prices ranged between essentially zero and 6¢/kWh in recent years, while SREC prices have been as high as 65¢/kWh.³⁵ SRECs in Massachusetts seem to have traded for around 20¢/kWh — a very substantial subsidy indeed relative to the cost numbers in Table 5.1. Thus RPS programs, like other state and local policies, may provide very large subsidies to solar generation depending on their stringency. Less stringent policies that impose only weak constraints on LSEs will provide very modest subsidies.

^{xvii}For a detailed discussion of these programs see Chapter 9 of this report and Schmalensee.³⁴

While the total per-kWh value of federal, state, and local subsidies to solar generation in different localities has not been tallied to date, the subsidies that are already in place as a result of current policies and programs have clearly been sufficient to fuel rapid growth in PV investments. Between the first half of 2012 and the first half of 2014, installed residential PV capacity in the United States more than doubled and utility-scale PV capacity quadrupled.

FINDING

Federal-level subsidies in the United States, assuming the current solar investment tax credit (ITC) is 50% effective, reduce the cost of the PV projects studied here by around 20% and the CSP projects by around 13%. These subsidies, in combination with the variety of state and local subsidies provided in California, Massachusetts, and many other states, have been sufficient to fuel rapid growth in PV generation, even though PV technology is notably more expensive than fossil alternatives.

5.6 CONCLUSIONS AND FINDINGS

Several of the results discussed in this chapter and summarized in Table 5.1 deserve emphasis. First, location matters. Because of differences in insolation, it is much cheaper to generate electricity using solar power in southern California than in central Massachusetts.

Second, as directly implied by the investment cost estimates in Chapter 4, the cost of electricity from utility-scale PV is much lower — by almost half — than the cost of residential-scale PV. Third, because CSP plants can only utilize direct sunlight, CSP-generated electricity is much more expensive in cloudy Massachusetts than in sunny California — 135% more expensive. Fourth, as we discuss in general terms in Chapter 3, it may be optimal to add no energy storage, a little energy storage, or a lot of storage to a CSP plant depending on insolation and electricity price patterns. We find that adding energy storage is less beneficial in central Massachusetts than in California mainly due to the former location's lower insolation.

Because electricity demand and thus wholesale electricity prices are usually higher than average during those times of the day and year when the sun is shining compared to those times when it is not, the average kWh of electricity produced from these hypothetical facilities (assuming these facilities had no effect on price patterns at their locations) would be worth, on average, 10% more than the average kWh of electricity produced from a pure baseload facility that had the same output in every hour of the year. Not only is this premium smaller than one might have expected, it was computed using current prices, which reflect systems with very low solar penetration. As discussed in greater detail in Chapter 8, the solar premium will decline as solar penetration rises substantially above current levels, and solar electricity may even become less valuable than average.

Reflecting the importance of BOS costs for PV installations, we find that reducing the cost of modules by half only reduces estimated costs by about 15% for the utility-scale projects we analyze, and 9% for the residential-scale projects. Recognizing that the residential PV market is immature (see Chapter 4), we present estimates of levelized cost under plausible values for system components in a mature market. This lowers our estimates of levelized cost by around a third. Still, in both the locations we studied, the cost of residential-scale PV remains well above the cost of utility-scale PV.

FINDING

Plausible reductions in the cost of crystalline silicon PV modules alone would be insufficient to make utility-scale PV systems competitive on a subsidy-free basis in the absence of a significant price on carbon. Improvements that reduce residential balance-of-system costs, whether by reducing materials use or reducing installation costs, could make a large contribution.

Reducing the cost of modules by half only reduces estimated costs by about 15% for the utility-scale projects we analyze, and 9% for the residential-scale projects.

Figure 5.3 Summary of Levelized Cost of Electricity Results

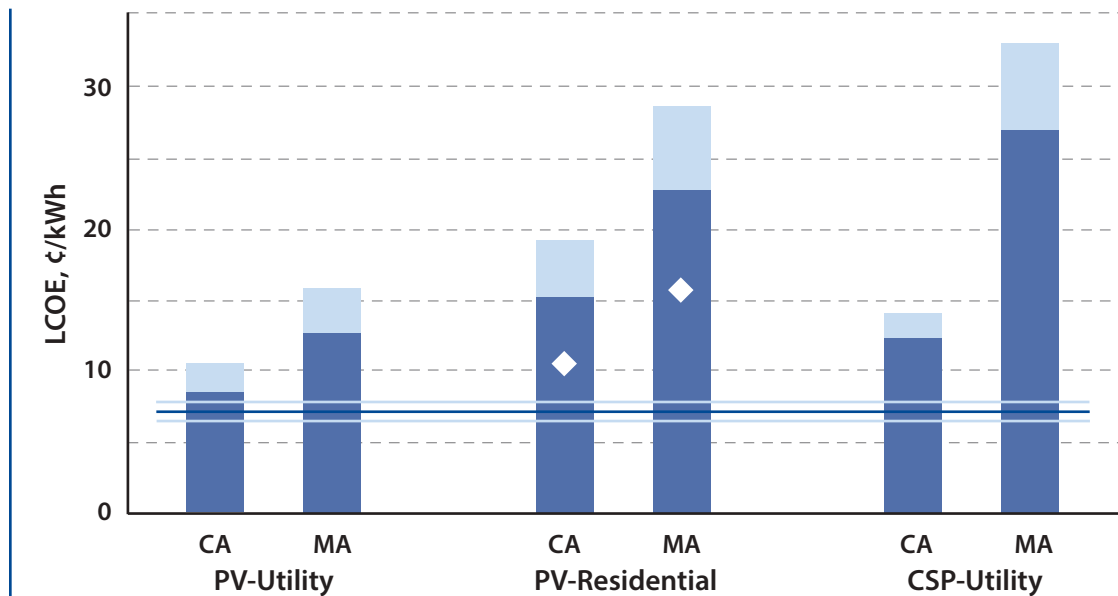

Note: The light blue bars show the LCOEs without subsidies as reported in this chapter. All LCOE figures are unadjusted, not reflecting any differential value for the time profile of power produced. The dark blue bar show the LCOEs reduced by the federal tax subsidy at 50% effectiveness as reported in this chapter. For the residential PV, the white diamonds show estimates after a reduction in BOS costs that brings U.S. costs in line with German costs. The dark solid line running across the figure shows a central estimate for the LCOE of an NGCC plant operated at baseload capacity based on data from the EIA as discussed in the chapter. It is inclusive of a carbon charge of \$38/ton CO₂. The light blue solid lines show a range for the LCOE of the natural gas plant reflecting different regional costs as reported by the EIA.

Table 5.1 The Levelized Cost of Electricity for Three Hypothetical Solar Installations in Two Different Locations under Alternative Assumptions

	Utility-Scale PV		Residential PV		Utility-Scale CSP	
	s. CA	c. MA	s. CA	c. MA	s. CA	c. MA
Base Case, ¢/kWh	10.5	15.8	19.2	28.7	14.1	33.1
Value Adjusted	9.3	14.4	17.0	26.2	12.6	29.5
Change from Base Case, ¢/kWh	-1.2	-1.4	-2.2	-2.5	-1.5	-3.6
Change from Base Case, %	-12%	-9%	-12%	-9%	-11%	-11%
50% Module Cost	8.9	13.4	17.5	26.2		
Change from Base Case, ¢/kWh	-1.6	-2.4	-1.7	-2.6		
Change from Base Case, %	-15%	-15%	-9%	-9%		
Reductions in BOS Cost			12.0	18.0		
Change from Base Case, ¢/kWh			-7.2	-10.8		
Change from Base Case, %			-37%	-37%		
With Federal Tax Subsidies, 50% ITC Effectiveness	8.4	12.7	15.2	22.8	12.2	28.5
Change from Base Case, ¢/kWh	-2.1	-3.1	-4.0	-6.0	-1.9	-4.7
Change from Base Case, %	-20%	-20%	-21%	-21%	-13%	-14%
With Federal Tax Subsidies, 100% ITC Effectiveness	6.8	10.1	12.0	18.0	10.2	23.9
Change from Base Case, ¢/kWh	-3.8	-5.6	-7.2	-10.8	-3.9	-9.2
Change from Base Case, %	-36%	-36%	-38%	-37%	-27%	-28%

Finally, we analyzed the effects of the main federal subsidies for solar generation in the United States. Assuming that most solar developers capture only 50% of the value of current federal tax subsidies, these subsidies reduced the levelized cost of solar electricity by 13%–21%, depending on the technology. A detailed effort to measure the subsidy effects

of renewable portfolio standards in California or Massachusetts, let alone the effects of various other state- and local-level support policies in these states and many others, was beyond the scope of our analysis. It is worth noting, however, that all of these subsidies have had and are having a dramatic impact on solar costs in at least some areas.

REFERENCES

- ¹Interagency Working Group on Social Cost of Carbon. *Technical Support Document: Technical Update of the Social Cost of Carbon for Regulatory Impact Analysis – Under Executive Order 12866*. (May 2013). http://www.whitehouse.gov/sites/default/files/omb/inforeg/social_cost_of_carbon_for_ria_2013_update.pdf
- ²*Historical Pricing Data Login*. GDF SUEZ Energy Resources NA, Inc. <http://www.gdfsuezenergyresources.com/historical-data>
- ³*NREL System Advisor Model (SAM): Levelized Cost of Energy (LCOE)* National Renewable Energy Laboratory. https://www.nrel.gov/analysis/sam/help/html-php/index.html?mtf_lcoe.htm
- ⁴Short, W., D. J. Packey, and T. Holt. *Manual for the Economic Evaluation of Energy Efficiency and Renewable Energy Technologies*. National Renewable Energy Laboratory. NREL/TP-462-517. (Mar 1995). <http://www.nrel.gov/docs/legosti/old/5173.pdf>
- ⁵Brealey, R., S. Myers and F. Allen. *Principles of Corporate Finance, 11th Edition*, McGraw Hill. Chapter 19 (2013). ISBN-13: 9780078034763.
- ⁶Namovicz, C. “Assessing the Economic Value of New Utility-Scale Generation Projects.” *Workshop on Assessing the Economic Value of New Utility-Scale Renewable Generation Projects Using Levelized Cost of Electricity and Levelized Avoided Cost of Electricity*. U.S. Energy Information Agency. (Jul 25, 2013). http://www.eia.gov/renewable/workshop/genccosts/pdf/1_Namovicz.pdf
- ⁷“Discussion Paper: Assessing the Economic Value of New Utility-Scale Electricity Generation Projects.” *Workshop on Assessing the Economic Value of New Utility-Scale Renewable Generation Projects Using Levelized Cost of Electricity and Levelized Avoided Cost of Electricity*. U.S. Energy Information Agency. (Jul 25, 2013). http://www.eia.gov/renewable/workshop/genccosts/pdf/lace-lcoe_070213.pdf
- ⁸“Levelized Cost of Electricity and Levelized Avoided Cost of Electricity Methodology Supplement.” *Workshop on Assessing the Economic Value of New Utility-Scale Renewable Generation Projects Using Levelized Cost of Electricity and Levelized Avoided Cost of Electricity*. U.S. Energy Information Agency. (Jul 25, 2013). http://www.eia.gov/renewable/workshop/genccosts/pdf/methodology_supplement.pdf
- ⁹Norris, B.L., M.C. Putnam and T.E. Hoff. *Minnesota Value of Solar: Methodology*. Minnesota Department of Commerce, Division of Energy Resources. (Apr 1, 2014). <http://mn.gov/commerce/energy/images/MN-VOS-Methodology-FINAL.pdf>
- ¹⁰Frank, C.R. *The Net Benefits of Low and No-Carbon Electricity Technologies*. Brookings Institution, Global Economy & Development Working Paper 73. (May 2014). <http://www.brookings.edu/~media/research/files/papers/2014/05/19%20low%20carbon%20future%20wind%20solar%20power%20frank/net%20benefits%20final.pdf>
- ¹¹Lovins, A.B. “Sowing Confusion About Renewable Energy.” *Forbes*. (Aug 5, 2014). <http://www.forbes.com/sites/amorylovins/2014/08/05/sowing-confusion-about-renewable-energy/>
- ¹²Hirth, L. “The Market Value of Variable Renewables: The Effect of Solar Wind Power Variability on Their Relative Price.” *Energy Economics* 38 (2013): 218-236. <http://www.sciencedirect.com/science/article/pii/S0140988313000285>
- ¹³Schmalensee, R. “The Performance of U.S. Wind and Solar Generating Plants.” *The Energy Journal*, Forthcoming (2014). http://papers.ssrn.com/sol3/papers.cfm?abstract_id=2334946
- ¹⁴Schmalensee, R. *The Performance of U.S. Wind and Solar Generating Plants*. MIT Center for Energy and Environmental Policy Research, Working Paper 2013-12. (2013). <http://web.mit.edu/ceepr/www/publications/workingpapers/2013-012.pdf>
- ¹⁵*PVWatts® Calculator*. National Renewable Energy Laboratory. (Sep 2014). <http://pvwatts.nrel.gov/>
- ¹⁶*Distributed Generation Energy Technology Operations and Maintenance Costs*. National Renewable Energy Laboratory. http://www.nrel.gov/analysis/tech_cost_om_dg.html
- ¹⁷Gowrisankaran, G., S. S. Reynolds, and M. Samano. *Intermittency and the Value of Renewable Energy*. No. w17086. National Bureau of Economic Research. (2011). <http://www.nber.org/papers/w17086.pdf>
- ¹⁸*Levelized Cost of New Generation Resources in the Annual Energy Outlook 2013*. U.S. Energy Information Administration. (Jan 2013). http://www.eia.gov/forecasts/aeo/er/pdf/electricity_generation.pdf
- ¹⁹*Transparent Cost Database*. OpenEI. <http://en.openei.org/apps/TCDB/>

- ²⁰*Assumptions of the Annual Energy Outlook, 2014*. U.S. Energy Information Administration. (Jun 2014). Tables 1.2 and 8.2. <http://www.eia.gov/forecasts/aeo/assumptions/pdf/0554%282014%29.pdf>
- ²¹*Schedule D: Domestic Service*. Southern California Edison. <https://www.sce.com/NR/sc3/tm2/pdf/ce12-12.pdf>
- ²²*Schedule DR - Residential Service (2/1/14-Current)*. San Diego Gas & Electric. https://www.sdge.com/sites/default/files/regulatory/020114-schedule_dr.pdf
- ²³*Electric Rates: Residential*. Pacific Gas & Electric. <http://www.pge.com/tariffs/electric.shtml>
- ²⁴*Schedule R: Residential Service*. Hawaiian Electric Company. <http://www.hawaiianelectric.com/vcmcontent/FileScan/PDF/EnergyServices/Tariffs/HECO/HECORatesSchR.pdf>
- ²⁵Kassakian, J. G., and R. Schmalensee. *The Future of the Electric Grid: An Interdisciplinary MIT Study*. Massachusetts Institute of Technology. (2011). 182. http://mitei.mit.edu/system/files/Electric_Grid_Full_Report.pdf
- ²⁶*NREL System Advisor Model (SAM): Welcome to SAM*. <https://sam.nrel.gov/>
- ²⁷Turchi, C.S., and G. A. Heath. *Molten Salt Power Tower Cost Model for the System Advisor Model*. National Renewable Energy Laboratory. NREL/TP-5500-57625. (Feb 2014). <http://www.nrel.gov/docs/fy13osti/57625.pdf>
- ²⁸Turchi, C.S., and G. A. Heath. *Molten Salt Power Tower Cost Model for the System Advisor Model*. National Renewable Energy Laboratory. NREL/TP-5500-57625. (Feb 2014): Appendix D – WorleyParsons Subcontract Report: Power Tower Plant Cost and Material Input to Life Cycle Assessment (LCA). NREL-8-ME-REP-0002 Rev2. <http://www.nrel.gov/docs/fy13osti/57625.pdf>
- ²⁹*Plant Cost Index*. Chemical Engineering. <http://www.chemengonline.com/pci-home>
- ³⁰*DSIRE: Database of State Incentives for Renewables & Efficiency*. North Carolina State University. <http://www.dsireusa.org/>
- ³¹Mackler, S. and N. Gorence. *Reassessing Renewable Energy Subsidies: Issue Brief*. Bipartisan Policy Center. (Mar 25, 2011). http://bipartisanpolicy.org/wp-content/uploads/sites/default/files/BPC_RE%20Issue%20Brief_3-22.pdf
- ³²Pololefsky, M. *Tax Evasion and Subsidy Pass-Through under the Solar Investment Tax Credit*. Working Paper 13-05, Department of Economics, University of Colorado at Boulder. (Nov 2013). http://rintintin.colorado.edu/~sandt/ThirdpartyPV_paper_14.pdf
- ³³*Wholesale Electricity and Natural Gas Market Data*. U.S. Energy Information Administration. (Feb 5, 2015). <http://www.eia.gov/electricity/wholesale/>
- ³⁴Schmalensee, R. “Evaluating Policies to Increase Electricity Generation from Renewable Energy.” *Review of Environmental Economics and Policy* 6, No. 1 (2012). 45–64. <http://reep.oxfordjournals.org/content/6/1/45.full.pdf+html>
- ³⁵Heeter, J., G. Barbose, L. Bird, et al. “A Survey of State-Level Cost and Benefit Estimates of Renewable Portfolio Standards.” National Renewable Energy Laboratory. NREL/TP-6A20-61042. (May 2014). <http://www.res4med.org/uploads/studies/1402067633NREL.pdf>
- ³⁶*New Report Shows U.S. Solar Industry Nearing 16 GW of Installed Capacity*. Solar Energy Industry Association. (Sep 4, 2014). <http://www.seia.org/news/new-report-shows-us-solar-industry-nearing-16-gw-installed-capacity>

The hyperlinks in this document were active as of April 2015.



Section IV – Scaling and Integration

INTRODUCTION

This section focuses on considerations that arise in a scenario where solar energy begins to meet a significant fraction of the world’s electricity demand. Chapter 6 considers the materials requirements for large-scale deployment of photovoltaic (PV) solar power. The next two chapters discuss the impact of large-scale PV deployment on electricity distribution networks (Chapter 7) and on the overall power system at the wholesale level (Chapter 8).

Chapter 6 explores the availability of three categories of resources — land, commodity materials, and critical elements — that are required for large-scale PV deployment. (There appear to be no serious resource constraints on large-scale deployment of concentrating solar power, the other major solar energy technology considered in this report.) Land does not present a significant obstruction to large-scale PV deployment. We evaluate potential constraints with respect to commodity materials and critical elements using a target deployment of 12.5 terawatts (TW) of PV capacity, the amount needed to supply roughly 50% of the world’s projected electricity demand in the year 2050. With the possible exception of flat glass production, which would have to be ramped up, we find that commodity material requirements would not constrain large-scale PV deployment over the 35-year period from 2015 to 2050. In contrast, PV technologies — particularly commercial thin-film technologies that employ specific, often scarce, elements that cannot be replaced without fundamentally altering the technology — may face deployment ceilings due to materials constraints. Several of the critical elements used in some thin-film technologies are not mined as primary products, but instead are currently produced in small quantities as byproducts of the mining and refining of major metals.

Chapters 7 and 8 examine how the penetration of solar power affects the cost of electricity distribution networks and the operation, prices, and generation mix of the bulk power system. At the distribution level, our analysis examines only the impacts of solar PV; at the level of the bulk power system we consider the impacts of both PV (whether at the residential, commercial, or utility level) and concentrated solar power (CSP).

Specifically, Chapter 7 uses a powerful computer model to simulate the effects of a large volume of solar PV connected to the distribution network, for several locations and network configurations. We find that intermittent PV generation changes power flow patterns in the grid, causing local problems that may require network upgrades and modifications. Although the proximity of PV generators to end users may reduce some network investment costs as well as some resistive electricity losses, mismatches between load and solar generation — both in terms of location and time — may reduce or even cancel these potential benefits. This strongly suggests that revisions are needed in the methods used to calculate both the allowed remuneration of regulated distribution companies and the network charges imposed on users of the distribution infrastructure. Significant penetration of PV and other forms of distributed generation not only means that

the uniformity of end-user demand patterns can no longer be assumed, it also means that the widely-used practice of applying volumetric, per-kilowatt-hour network charges with a single standard meter can result in serious issues of cross-subsidization between network users with and without generation assets.

Chapter 8 reports on simulations that examine the impact of significant levels of solar generation on the bulk power system. Specifically, the chapter considers impacts on operations, planning, and wholesale market prices.

At high levels of PV penetration, incremental additions of PV capacity have only limited impact on the total non-PV generating capacity needed to meet demand. Incremental PV additions have no impact at all in systems where annual peak load occurs at night. Impacts on market prices and plant revenues strongly depend on the existing generation mix. Adding substantial PV capacity displaces those existing plants with the highest variable costs and increases the cycling requirements imposed on thermal plants, leaving less room for electricity production using less flexible technologies. The more flexible the generating mix, the less relevant the cycling effect will be. Very large-scale deployment of solar PV will make it increasingly necessary to curtail solar production (and/or other zero-variable-cost production) for economic reasons, in particular to avoid costly cycling of thermal power plants. The coordination of solar production and storage (including the use of reservoir hydro) reduces cycling requirements for thermal plants on the system and enhances solar's capacity value.

Even if PV generation becomes competitive at low levels of penetration, a substantial scale-up of PV deployment will reduce the per-kilowatt profitability of installed PV capacity until a system-dependent breakeven point is reached, beyond which further investments in solar PV are no longer profitable.

Chapter 6 – PV Scaling and Materials Use

6.1 INTRODUCTION

As discussed in Chapter 1 of this report, solar energy is one of the few primary energy sources suitable for large-scale use in a carbon-constrained world. Solar photovoltaics (PV) accounted for approximately 0.85% of global electricity production in 2013 and approximately 139 gigawatts of installed peak capacity (GW_p).¹ Given current estimates that as much as 25,000 GW of zero-carbon energy will be required by 2050 to achieve the international community's goal of avoiding dangerous anthropogenic interference with the earth's climate, PV deployment could be called upon to scale up by one to two orders of magnitude by mid-century.^{2,3}

Predicting the future trajectory of any nascent technology is difficult, and PV is no exception (Box 6.1). On one hand, cumulative PV capacity worldwide has grown at roughly 47% per year since 2001 — a trend that, if it were naively projected into the future, would suggest that the entirety of the world's electricity demand will be satisfied by PV within the next twelve years.⁴ A more realistic analysis, on the other hand, would recognize that while high growth rates may be easy to maintain for initially small levels of production, growth rates inevitably fall as demand begins to saturate and as deployment approaches physical limits to growth. Some bottlenecks — in PV manufacturing capacity or labor availability, for example — can be addressed rapidly and are not intrinsically limiting. Other constraints — such as the availability of critical materials or suitable land area — could conceivably present harder limits. This chapter examines potential limits on

scaling PV deployment to the multiple-terawatt level, with a focus on constraints related to material production capacity and availability.

Cumulative PV capacity worldwide has grown at roughly 47% per year since 2001.

In Section 6.2 we analyze production requirements for commodity materials such as glass, aluminum, and concrete, based on a future dominated by today's commercial PV technologies, including crystalline silicon (c-Si), cadmium telluride (CdTe), and copper indium gallium diselenide (CIGS).¹ Since these technologies are already in use and balance-of-system (BOS) requirements are well known, it is possible to make detailed projections of materials use under different scaling scenarios. These projections are valid as long as module form factors do not change substantially. Estimates based on current silicon PV technology may constitute an upper bound on commodity materials usage; as noted in Chapter 2, some emerging thin-film technologies may be able to achieve much lower BOS requirements than silicon, perhaps by employing lightweight and/or flexible modules with thin absorber layers. Concentrating solar thermal power (CSP, discussed in Chapter 3) relies solely on such commodity materials, but given the relatively small number of large-scale CSP plants, the fact that CSP systems are less modular in nature than PV systems, and the possibility that future CSP plants could demonstrate different material requirements if higher-temperature technologies are developed, we do not consider material scaling issues for CSP here.

¹The analyses in this section and following sections are also discussed in a recent publication by members of the study group.⁵

In Section 6.3 we consider critical elements that are necessary components of certain PV technologies, but that are — in some cases — rare in the earth's crust and/or occur only rarely in concentrated ores. Examples of such elements include silicon for c-Si PV, tellurium for CdTe, and gallium, indium, and selenium for CIGS.ⁱⁱ Unlike commodity materials, these critical

technology-specific material intensities. Annual production could be limited by global material extraction capacity, while annual production growth rates could be limited by the rate of expansion of processing capacity and by the rate of discovery of new resources. Limits on both annual production and annual growth rates are complicated by the economics of byproduction. At present, the critical materials discussed here, with the exceptions of silicon and silver, are produced as relatively minor byproducts during the production of other metals. Substantially increasing the output of these critical materials would require either extracting such materials more efficiently from the primary ores of other metals through changes to refining methods, or producing them as primary products. Either path would likely entail significant increases in cost. Historical growth of global metals production informs our chances of achieving terawatt-scale PV deployment by mid-century using material-constrained PV technologies.

Section 6.4 discusses different approaches to addressing material scaling limits. Critical materials limitations could be circumvented either by reducing material intensity (grams of material per peak watt delivered) or by using more abundant materials. For some commercial PV technologies, the required reductions in critical material intensity are impractically large. These technologies may be relegated to a minor role in a dramatic expansion of PV capacity. Some emerging thin-film technologies may offer a sustainable alternative with substantially lower critical material requirements.

PV technologies that employ scarce elements may encounter a deployment ceiling due to limits on cumulative production.

materials have few, if any, substitutes in a given PV technology. In most cases they are part of the light-absorbing and charge-transporting layer; in these cases, substituting another element would amount to introducing a new PV technology. We also include silver, which is used to form the electrical contacts on silicon solar cells, in this analysis. While silver is not part of the current-generating active material of the cell and while PV industry roadmaps project the introduction of more abundant, lower-cost alternatives in the coming decade, silver currently accounts for a large fraction of the cost of silicon solar cells and provides useful context as a scarce material with a long production history.⁶

PV technologies that employ scarce elements may encounter a deployment ceiling due to limits on cumulative production (tons), annual production (tons/year), or annual production growth rates (tons/year per year). Cumulative production is, in principle, limited only by the crustal abundance of key elements and

ⁱⁱIndium is also used in the indium tin oxide (ITO) transparent electrode for CdTe PV and many emerging thin-film PV technologies, though at less than one-quarter the intensity (measured in tons/GW_p) of its use in CIGS.

BOX 6.1 SOLAR GROWTH AND COST PROJECTIONS

Each year the International Energy Agency (IEA) releases its *World Energy Outlook* (WEO) publication, which summarizes the current state of the world's energy systems and makes projections for how those systems will shift in the future. The growth of solar power (PV and CSP) has consistently outstripped the IEA's "reference scenario" projections: the 2006 WEO projection for cumulative solar capacity in 2030 was surpassed in 2012 and the 2011 WEO projection for 2020 was surpassed in 2014.⁷⁻¹⁴ Past growth projections for solar energy from the U.S. Department of Energy's Energy Information Administration (EIA) have similarly underestimated actual growth.¹⁵⁻¹⁷ Even the IEA scenarios that assume more aggressive policy interventions to address global climate change (specifically, IEA's "New Policies" and "450 ppm" scenarios), and that therefore factor in the

effects of renewable energy deployment policies, have underestimated the growth of solar power. While the high rate of growth of solar power worldwide is eventually expected to slow as grid integration difficulties become more dominant (see Chapters 7 and 8), these trends highlight the possibility that solar technologies could supply a greater fraction of the future energy supply mix than current growth projections suggest.

The cost of PV installations has also fallen much more rapidly than projected. In 2014, prices for residential PV systems reached the level projected for installed PV capital costs in 2030 according to EIA's 2009 *International Energy Outlook* report, and utility PV system prices have fallen even faster.¹⁸ Figure 6.1 shows actual solar capacity growth and recent cost trends compared to projections.

Figure 6.1 Solar Capacity Growth and Costs Compared to Projections

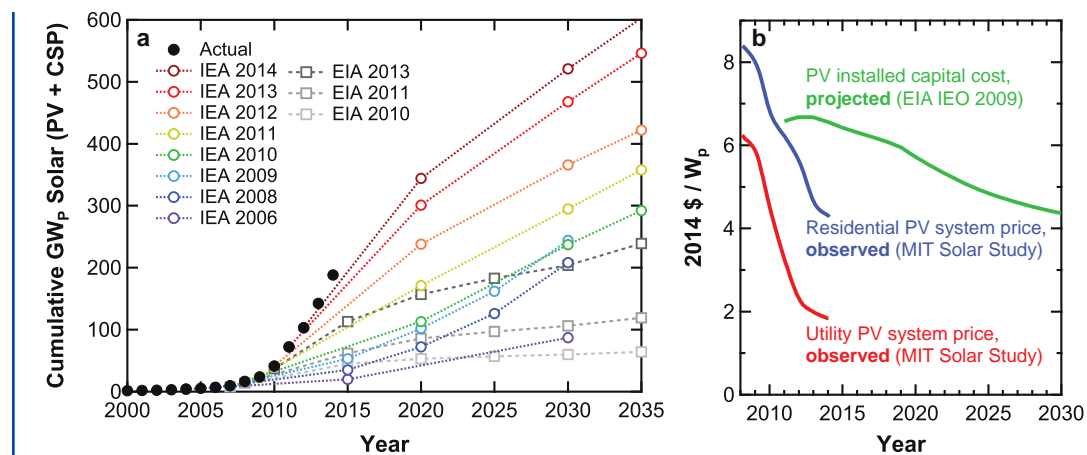

Note: In Figure 6.1a, International Energy Agency (IEA) and Energy Information Administration (EIA) projections for cumulative PV and CSP installed capacity are represented by empty colored circles and squares; actual historical data for cumulative PV and CSP installed capacity are represented by filled black circles. Dotted lines are given as guides to the eye. Projections are from the IEA *World Energy Outlook* reports over the period from 2006 to 2014⁷⁻¹⁴ and the EIA *Annual Energy Outlook* reports over the period from 2010 to 2013;¹⁵⁻¹⁷ actual data for cumulative PV capacity are from EPIA⁴ and IHS, Inc.;¹⁹ actual data for cumulative CSP capacity are from REN21.²⁰ In Figure 6.1b, observed prices are from Chapter 4 of this report; cost projections are from EIA¹⁸ and are presented in 2014 dollars.

Demand Projections

Any quantitative analysis of PV scaling limits must make an assumption about future electricity demand (kilowatt-hours per year [kWh/year]) and the fraction of that demand that will be satisfied by PV (the *PV fraction*). Multiplying demand by the PV fraction gives projected total PV generation; further dividing by an assumed capacity factor and the number of hours in a year gives the total installed PV capacity required to meet projected demand (W_p).

Projections of the fraction of electricity demand satisfied by PV at various points in the future vary widely.

Projections of the fraction of electricity demand satisfied by PV at various points in the future vary widely; estimates for 2030 range from 1% to 75%.^{17,21} For this analysis we do not pick a specific projection for the future energy mix, but rather estimate the peak installed capacity needed to satisfy 5%, 50%, or 100% of global electricity demand in 2050 with solar PV generation. We use these capacity projections throughout the chapter to analyze material availability constraints for different PV technologies. For a given material and technology, we can compare total material requirements in tons to current annual production in tons/year, indicating the number of years of current production that would be required to deploy a particular technology at a particular scale. We can then compare the growth rate in materials production required to meet these targets with historical growth rates in the production of a collection of metals.

Our analysis can be rescaled easily to account for different capacity targets and PV technology mixes, simply by scaling the values calculated for a 100% PV share of future generation by the desired multiple. The year 2050 is chosen to match widely cited climate change mitigation targets.^{3,22,23} In its 2°C global warming scenario, the International Energy Agency (IEA) projects that worldwide electricity demand in 2050 will total 33,000 terawatt-hours (TWh).²⁴ This baseline demand projection, along with an annual- and global-average PV capacity factor of 15%,ⁱⁱⁱ is assumed for all calculations in this chapter. We make the simplifying assumption that the power system can fully utilize any amount of solar generation regardless of its temporal profile; the annual energy demand divided by the capacity factor and the length of a year then corresponds to an installed capacity of 25 terawatts (TW_p) at a 100% PV fraction (in other words, assuming that PV supplies all 33,000 TWh of projected global electricity demand).

Land Use

Given the diffuse nature of the solar resource, it might be expected that land constraints would constitute a barrier to scaling PV deployment to a level sufficient to meet a large share of U.S. or global electricity demand. This point and the details of our analysis are addressed in Appendix A, but we briefly discuss the chief findings here.

As an example, we consider supplying all of U.S. electricity demand in the year 2050, projected to total roughly 4,400 TWh (or 0.5 TW averaged over the course of a year),

ⁱⁱⁱCurrent annual-average PV capacity factors range from approximately 10% in Germany²⁵ to approximately 20% in the United States.²⁶ The difference is primarily due to differences in insolation. Global-average capacity factors will likely increase with time, as deployment is expanding fastest in countries with higher insolation than Germany. With global-average solar irradiance over land at 183 watts per square meter (W/m^2)²¹ and a typical direct-current-to-alternating-current (dc-to-ac) derate factor of approximately 0.8, we expect the long-term global average capacity factor to approach approximately 15%.

with PV.²⁴ The land area that must be dedicated to PV in this case is indeed large — roughly 33,000 square kilometers (km²), or 0.4% of the land area of the United States. Nevertheless, this figure is comparable in magnitude to land areas currently employed for other distinct uses in the United States, as shown in Figure 6.2.

Some comparisons in Figure 6.2 are worth noting. For example, the land area required to supply 100% of projected U.S. electricity demand in 2050 with PV installations is roughly half the area of cropland currently devoted to growing corn for ethanol production, an important consideration given the neutral or negative energy payback of corn ethanol and other complications associated with this fuel source.^{iv,27} That same land area — i.e., 33,000 km² to supply 100% of U.S. electricity demand with PV — is roughly equal in size to the area that has been disturbed by surface mining for coal,^{v,29-31} and it is less than the land area occupied by major roads.^{vi} The currently existing rooftop area within the United States provides enough surface area to supply roughly 60% of the nation's projected 2050 electricity needs with PV.³²

The land area required to supply 100% of projected U.S. electricity demand in 2050 with PV installations is roughly half the area of cropland currently devoted to growing corn for ethanol production.

It is also worth noting that PV installations do not necessarily monopolize land area, but can share land currently employed for other uses. Rooftop installations are an obvious example of dual use; livestock pastures can be combined with sparse solar tracking installations, and many highway and power line rights-of-way could accommodate PV installations in currently underutilized buffer zones.

6.2 COMMODITY MATERIALS

We use the term “commodity materials” to refer to common materials that are used in PV modules and systems but that are not intrinsically required for solar cell operation. These materials share a number of properties that distinguish them from PV-critical materials.

Following an analysis by the U.S. Department of Energy's National Renewable Energy Laboratory,³⁷ we classify six materials frequently used in PV facilities as commodity materials:

- Flat glass – encapsulation for modules, substrate for thin-film PV
- Plastic^{vii} – environmental protection
- Concrete – system support structures
- Steel – system support structures
- Aluminum – module frame, racking, supports
- Copper – wiring

^{iv}In 2013, ethanol contributed just under 7% of the energy content of U.S. gasoline.²⁸

^vSome of this land has since been reclaimed for other uses.

^{vi}According to Denholm and Margolis,³² the major road distinction “includes interstate, arterial, collector, and urban local roads. Does not include rural local and rural minor collector roads. These minor roads have a large area, but are not included due to data uncertainties, especially regarding lane width.”³³

^{vii}Including all thermoplastics and thermosets as listed by the American Chemistry Council.³⁸

Figure 6.2 Land Requirements for Large-Scale PV Deployment Compared to Existing Land Uses

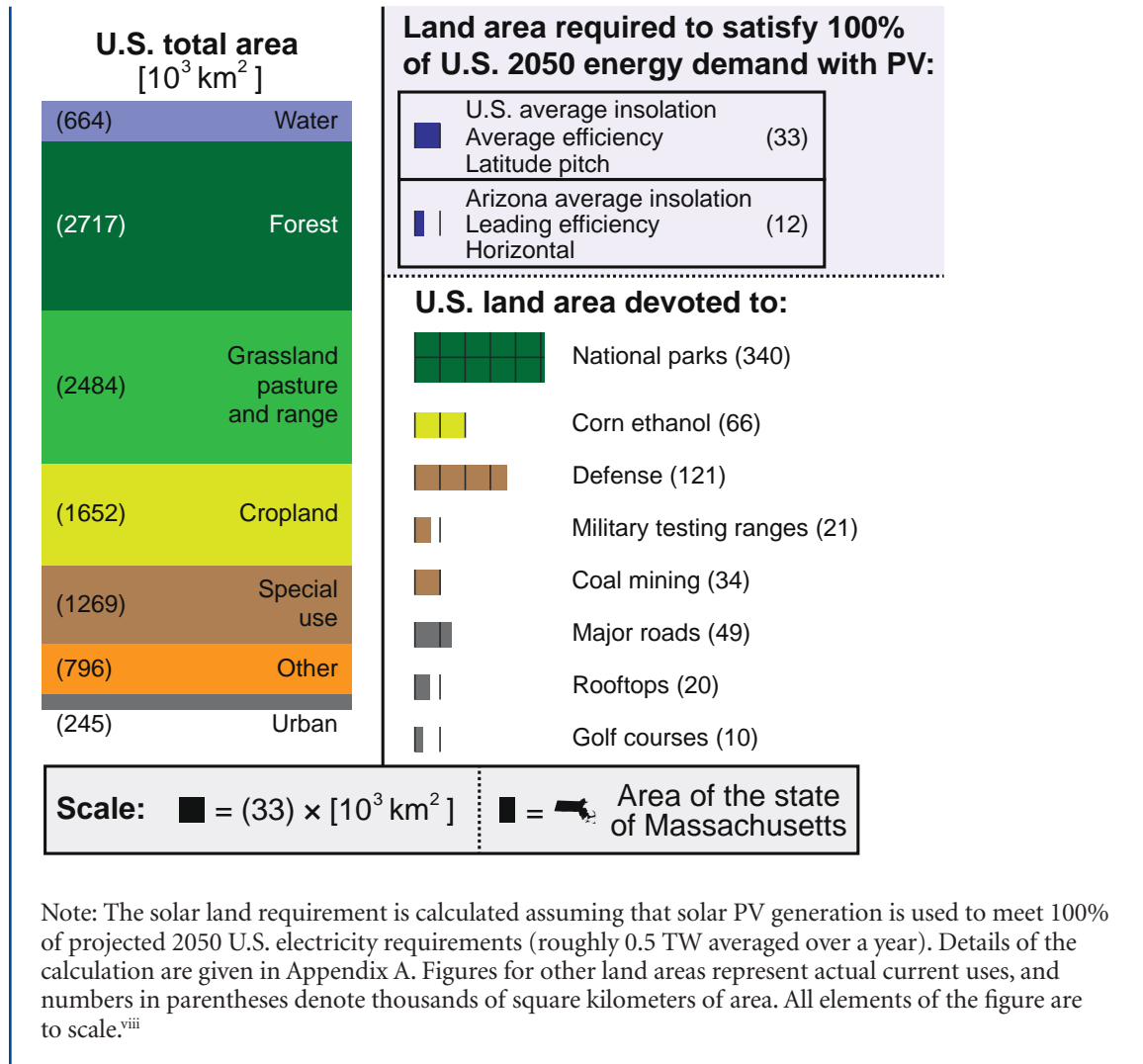

These materials are mined and/or produced as primary products at scales above 10 million (1x10⁷) tons per year. The primary influences that govern their long-term global production are thus market conditions and production

capacity rather than material abundance. These commodity materials are used in a variety of non-PV applications and are transferable between different end uses with little change in form; for example, the concrete and copper

^{viii}Land classes (“urban,” etc.) are taken from U.S. Department of Agriculture.³⁴ “National parks” is from the National Park Service.³⁵ “Corn ethanol,” “major roads,” “rooftops,” and “golf courses” are from Denholm and Margolis.³² “Defense” is from the U.S. Department of Defense.³⁶ “Military testing ranges” corresponds to the sum of the net land area given by Wikipedia for four distinct U.S. testing ranges: Utah Test and Training Range (6,930 km²), White Sands Missile Range (8,300 km²), McGregor Range Complex (2,400 km²), and Yuma Proving Ground (3,387 km²). “Coal mining” corresponds to the net land area that has been disturbed by surface mining for coal and is taken from multiple sources.²⁹⁻³¹ This chart was developed in conjunction with MIT subject ESD.124, “Energy Systems and Climate Change Mitigation.”

wiring used in a PV array are no different from the concrete and copper wiring used in the construction of an office building.

Here we estimate commodity materials requirements as a function of the fraction of global electricity demand satisfied by PV, assuming commodity material intensities representative of current commercial PV technologies (c-Si, CdTe, and CIGS).³⁷ Estimated materials requirements can be translated into multiples of current annual production, or into required annual growth rates until 2050. Comparing these projections with historical growth rates may help to identify potential limits on PV deployment stemming from the availability of commodity materials. However, it is important to note that future demand for commodity

materials from other applications is difficult to predict, and that PV applications currently account for only a small fraction of total demand for each of the major commodities considered in our analysis.

Figure 6.3 shows the cumulative amount of each commodity material that would have to be produced between now and 2050 in order to deploy sufficient PV capacity to satisfy 5%, 50%, and 100% of global electricity demand in 2050 (corresponding to 1.25 TW_p, 12.5 TW_p, and 25 TW_p of installed PV capacity, respectively, under the assumptions noted in Section 6.1). By comparing these numbers (plotted against the horizontal axis of Figure 6.3) with the current total annual production of each commodity material

Figure 6.3 Commodity Materials Requirements for Large-Scale Deployment of Current PV Technologies (Primarily Silicon)

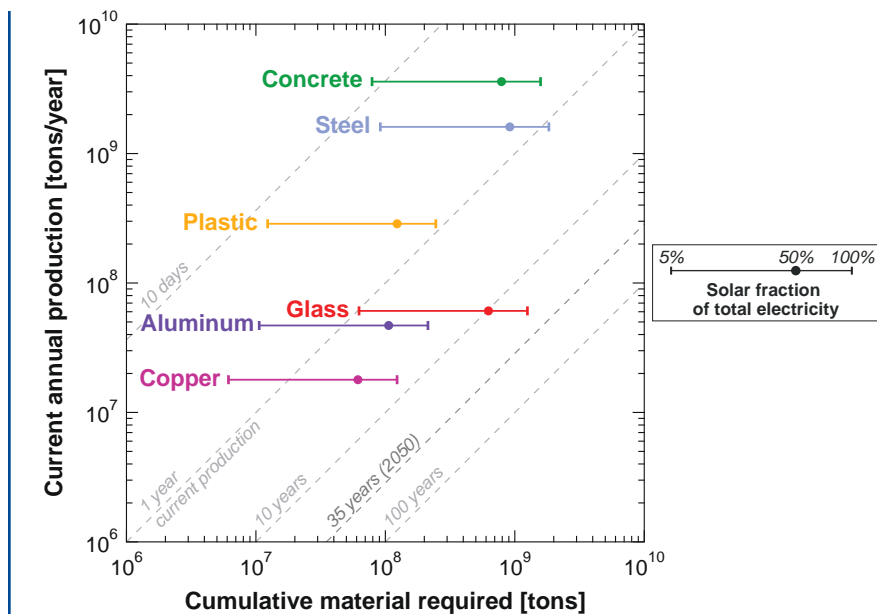

Note: Figure 6.3 shows, for each of six commodity materials, current total annual production (against the vertical axis) and the total amount of material required to deploy sufficient solar PV capacity to satisfy 5%, 50%, or 100% of projected global electricity demand in 2050 (against the horizontal axis). Gray dashed lines indicate the number of years of current production required to satisfy a cumulative material target. Only flat glass, and to a lesser extent, copper and aluminum would require a significant expansion or redirection of current production to achieve estimated commodity material requirements under the 100% solar PV scenario. Current annual production levels for copper,³⁹ aluminum,³⁹ steel,³⁹ glass,⁴⁰ plastic,³⁸ and concrete⁴¹ are taken from the literature; material intensity numbers are derived from NREL.³⁷

(plotted against the vertical axis), we can estimate the extent to which existing commodity material markets would have to expand to accommodate global PV demand. For example, current PV modules employ flat glass sheets as substrates and encapsulation layers. To satisfy 50% of projected 2050 world electricity demand with today's PV technologies would

meet 100% of projected global electricity demand in 2050 (i.e., 25 TW_p installed capacity) exceeds six years at current annual production levels. This result suggests that large-scale PV deployment may eventually become a major driver for these commodity markets. More limiting materials constraints may arise for the so-called *PV-critical elements* that are in most cases directly responsible for the solar energy conversion process in PV modules. These critical-element constraints are considered in the next section.

There appear to be no major commodity material constraints for terawatt-scale PV deployment through 2050.

require 626 million (6.26×10^8) metric tons of glass (red dot in Figure 6.3). At today's world-wide flat-glass production level of 61 million metric tons per year, approximately 10 years' worth of extra production would have to be allocated for PV applications between now and 2050 to achieve 50% PV penetration, as indicated by the position of the red dot near the gray dotted line labeled "10 years" in the figure. In other words, flat-glass production would, on average, need to be 29% higher than its current value for the next 35 years to satisfy flat-glass demand for the 50% PV penetration case (assuming the demand for flat glass from all other end-use sectors does not change).

In sum, there appear to be no major commodity material constraints for terawatt-scale PV deployment through 2050. This rule tends to apply generally: growth rates in production capacity for commodity materials are usually not limited by raw materials, but rather by factors such as the availability of good production sites and skilled personnel.^{ix} For some commodities, such as glass, aluminum, and copper, the amount of material required to support solar PV deployment at a level sufficient to

FINDING

PV modules will become a major driver of flat-glass production at high solar penetration levels, but the availability of commodity materials imposes no fundamental limitations on the scaling of PV deployment for scenarios in which a majority of the world's electricity is generated by PV installations in 2050.

6.3 CRITICAL MATERIALS

The PV technologies described in Chapter 2 make use of chemical elements that differ greatly in abundance, yearly production, and historical rates of production growth. For example, silicon is the second most abundant element in the earth's crust, while tellurium is estimated to be about one-quarter as abundant as gold.⁴³ In 2012, the world produced 7.8 million tons of silicon and just 380 tons of gallium. And the production of indium has grown at an average annual rate of 9.8% over the past 20 years, while selenium production has grown at a rate of just 1.2% per year.^{39,44}

^{ix}Military aircraft production in the United States grew by one-to-two orders of magnitude between 1939 and 1944, highlighting the tremendous level of growth that is possible for commodity-based goods.⁴²

The large-scale deployment of solar power systems that employ scarce elements would vastly increase demand for these resources. Unlike many other aspects of solar power systems, the use of scarce elements does not benefit from economies of scale. On the contrary, because these elements are genuinely scarce, their contribution to the cost of solar energy technologies is likely to increase with the scale of deployment in ways that are difficult to predict or control. This section examines the possible constraints on PV deployment presented by six PV-critical elements:^x silicon and silver in c-Si solar cells; tellurium in CdTe solar cells; and gallium, indium, and selenium in CIGS solar cells. For each of these elements we consider potential constraints on cumulative production in tons, yearly production in tons per year, and growth in yearly production in tons-per-year per year, and we compare future production requirements with physical limits and historical experience.

Cumulative Production [tons]

Table 6.1 summarizes data on the relative crustal abundance of the six PV-critical elements (as a fraction of the weight of the earth's crust),⁴³ cumulative world production from 1900 to 2012,³⁹ and levels of cumulative production required to support future PV deployment at a scale commensurate with 100% PV penetration by mid-century.

The use of scarce elements does not benefit from economies of scale.

It should be noted that the *absolute* amount of any of these PV-critical elements in the earth's crust is not expected to constrain future PV deployment. For example, even if CdTe PV installations are used to supply 100% of projected global electricity demand in 2050, the quantity of tellurium required would amount to roughly one ten-millionth (1/10,000,000)

Table 6.1 Abundance and Cumulative Production of PV-Critical Elements

	Silicon ^{xi}	Silver	Tellurium	Gallium	Indium	Selenium
Abundance [fraction] ^{xii}	0.28	7.5×10^{-8}	1.0×10^{-9}	1.9×10^{-5}	2.5×10^{-7}	5.0×10^{-8}
Cumulative production (1900–2012) [10^6 tons] ³⁹	160	1.1	0.010	0.0026	0.010	0.091
Cumulative amount in PV by 2050 for 100% PV penetration [10^6 tons]	51	0.60	0.79	0.11	0.19	0.51
Ratio of 2050 PV cumulative production to cumulative 1900–2012 production	0.32	0.53	76	43	18	5.6

^xPrevious work along the same lines can be found in Andersson et al.,⁴⁵ NREL PV-FAQs,³⁷ Feltrin et al.,⁴⁶ Green,⁴⁷ Zweibel,⁴⁸ and Wadia.⁴⁹ For an introduction to energy critical elements, see Jaffe and Price,⁵⁰ National Research Council,⁵¹ and DOE.⁵²

^{xi}Our data on silicon production include both metallurgical grade silicon, which is the present feedstock for c-Si PV applications, and ferrosilicon, a lower-purity alloy used primarily in steel manufacturing. Our method of analysis implicitly assumes that ferrosilicon production could be redirected toward metallurgical grade silicon if demand were sufficient. If silicon currently used in ferrosilicon production could not be directed toward metallurgical grade silicon production, then higher rates of growth in silicon production would be required to meet our stated PV deployment targets.

^{xii}Stated abundances are taken from the CRC Handbook of Chemistry and Physics,⁴³ but it should be noted that there is naturally some uncertainty in these values and different estimates are available from other sources. The range of estimates for the crustal abundance of the six PV-critical elements across six different references^{43,53-57} are: silicon, 0.27–0.30; silver, $7.0\text{--}8.0 \times 10^{-8}$; tellurium, $1.0\text{--}2.0 \times 10^{-9}$; gallium, $1.7\text{--}1.9 \times 10^{-5}$; indium, $0.5\text{--}2.5 \times 10^{-7}$; selenium, $5.0\text{--}15 \times 10^{-8}$. Our conclusions are not sensitive to the range of uncertainty displayed across these data sets.

of the tellurium estimated to be present in the earth's crust. However, the mining of any element^{xiii} is only economical when that element is concentrated at ratios well above its average concentration. If all deposits were known and competition were perfect, then, as the most concentrated deposits were depleted, production would shift to less and less concentrated deposits and production costs would rise. Geopolitical factors, improvements in exploration and extraction techniques, and the economics of byproduction can all complicate this simple picture.

A detailed analysis of the *economically recoverable* fraction of different PV-critical elements as a function of PV demand is beyond the scope of this study, but a comparison of the relative abundances of these elements provides a useful sense of scale when considering different PV technology options as candidates for large-scale deployment. Silicon is 20,000 times as abundant as gallium (the next most abundant PV-critical element) and 300 million times as abundant as tellurium; to supply 100% of projected global electricity

The current economics of PV-critical elements is primarily dictated by the fact that, with the exception of silicon, these elements are typically produced as byproducts of other, more common elements.

demand in 2050 with c-Si PV would require roughly one-third as much silicon as has already been produced since 1900. While silver is one of the least abundant elements considered here, it has been highly valued for millennia and primary mining of silver is a well-established industry. The amount of silver required to support c-Si PV deployment at the scale required in the 100% penetration case, assuming current material intensities, would correspond to roughly half the global cumulative

production of silver since 1900. Complete reliance on CdTe or CIGS PV at current material intensities, on the other hand, would require the production of roughly 76 times more tellurium and 43 times more gallium, respectively, for use in PV installations than has ever been produced for all other uses combined.

Yearly Production [tons/year]

Current rates of production for PV-critical elements provide a more useful point of reference than relative crustal abundances when considering questions of scale. As discussed below, yearly production and price are not necessarily linked to abundance: selenium, for example, costs less and is more copiously produced than gallium and indium, even though it is the least abundant of the three. The current economics of PV-critical elements is primarily dictated by the fact that, with the exception of silicon, these elements are typically produced as byproducts of other, more common elements. We begin by comparing the amount of material required to support our three 2050 PV deployment targets with current rates of production of the six PV-critical materials considered here. We then apply a similar analysis to critical materials for battery energy storage. Finally, we elaborate on the economics of byproduction.

Figure 6.4, which follows the same format as Figure 6.3, compares the total quantities of key elements required to satisfy 5%, 50%, and 100% of projected world electricity demand in 2050 with wafer-based, commercial thin-film, and emerging thin-film PV technologies.

For example, supplying 100% of projected global electricity demand in 2050 using CdTe PV installations (green data points in Figure 6.4b) would require similar amounts of cadmium and tellurium: 737,000 metric

^{xiii}Apart, perhaps, from the eight major rock-forming elements (oxygen, silicon, aluminum, iron, calcium, sodium, potassium, and magnesium), which are all present at abundances above 2% in the earth's crust.

Figure 6.4 Critical Materials Requirements for Large-Scale Deployment of Different PV Technologies

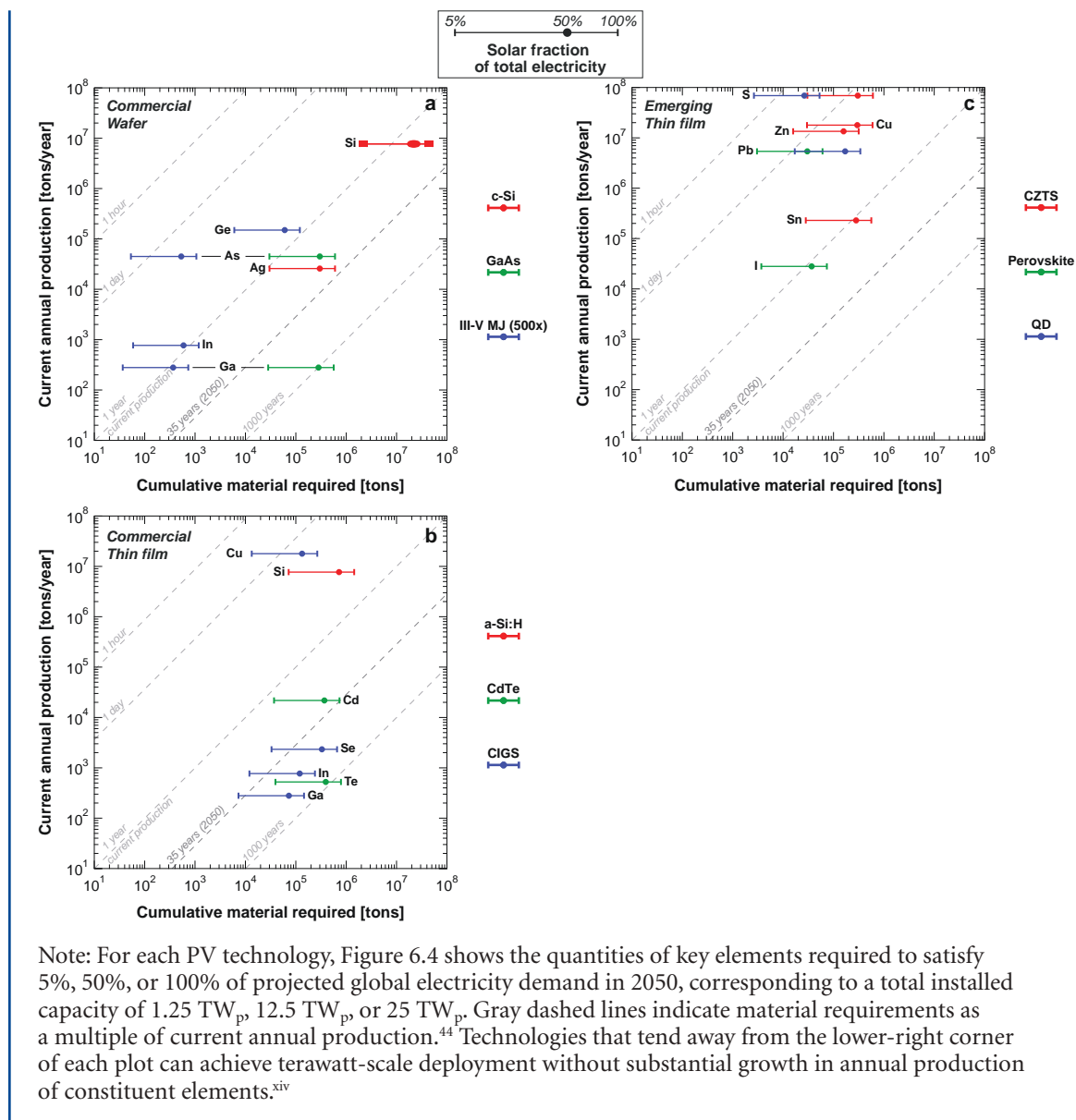

Note: For each PV technology, Figure 6.4 shows the quantities of key elements required to satisfy 5%, 50%, or 100% of projected global electricity demand in 2050, corresponding to a total installed capacity of 1.25 TW_p , 12.5 TW_p , or 25 TW_p . Gray dashed lines indicate material requirements as a multiple of current annual production.⁴⁴ Technologies that tend away from the lower-right corner of each plot can achieve terawatt-scale deployment without substantial growth in annual production of constituent elements.^{xiv}

^{xiv}Material intensity values are calculated using typical device structures and absorber compositions, assuming 100% materials utilization and cell manufacturing yield and module efficiencies equal to current lab-cell record efficiencies, as discussed in Chapter 2. (These assumptions are optimistic and could underestimate the amount of material required, but they serve as a simple and traceable point of comparison.) Material intensities are calculated for III-V multi-junction (MJ) solar cells based on the standard triple-junction structure described in Chapter 2, for a-Si:H cells based on an a-Si:H/nc-Si:H/nc-Si:H triple-junction, for CIGS based on a Cu:In:Ga:Se stoichiometry of 1:0.5:0.5:2, and for perovskite cells based on the mixed-halide perovskite $\text{CH}_3\text{NH}_3\text{PbI}_2\text{Cl}$. The boxes and ovals for c-Si represent the range spanned by single- and multi-crystalline silicon cells. A concentration ratio of 500x is assumed for III-V MJ solar cells. Organic and dye-sensitized solar cells require only abundant elements and are omitted.

tons and 785,000 metric tons, respectively. Both elements thus appear at roughly the same position along the horizontal axis (notice that both axes are logarithmic). But current annual production of cadmium (at 21,800 tons/year) exceeds that of tellurium (at 525 tons/year) by two orders of magnitude. As a result, the points for tellurium appear well below those for cadmium on the vertical axis. Deploying 25 TW_p of CdTe PV capacity would require the equivalent of 35 years of global cadmium production and 1,400 years of global tellurium production at current rates, as indicated by the diagonal gray lines in Figure 6.4b.

It is important to note that large-scale integration of solar and other intermittent, non-dispatchable renewable energy technologies will likely require large-scale deployment of grid-scale energy storage (see Appendix C), which would also carry critical material requirements. Rechargeable batteries are leading candidates for such applications, and since the energy capacity of a battery is proportional to the mass of active material used, grid-scale deployment may significantly increase the demand for some raw materials. Box 6.2 applies the analysis method described here for PV critical materials to critical materials for battery energy storage.

BOX 6.2 MATERIALS SCALING FOR BATTERY ENERGY STORAGE

To quantify material requirements for widespread deployment of several commercial and emerging battery technologies we apply the same approach used in this chapter to analyze commodity and PV-critical materials scaling issues. Battery technologies differ primarily in the active materials used in the positive and negative electrodes — each possible pair is known as a battery couple. Battery couples are grouped into aqueous, high temperature, lithium-ion (Li-ion) and lithium-metal (Li-metal), flow, and metal air technologies, as shown in Figure 6.5.

For each battery couple, we calculate the amount of key limiting elements theoretically required to store 1% (0.9 TWh), 10% (9 TWh), or 55% (50 TWh) of projected global daily electricity demand in 2050,²⁴ where 55% corresponds roughly to the storage capacity required to

enable 100% solar electricity generation under typical U.S. demand patterns.^{xv} The analysis of limiting elements is adapted from Wadia et al.,^{xvi} based on the element in each couple that limits the potential annual production of batteries based on that couple, assuming all of the material is used to make batteries. Gray dashed lines indicate material requirements as a multiple of current annual worldwide production.⁵⁹

Technologies that tend away from the lower-right corner of each plot can achieve multi-TWh deployment scale without substantial growth in annual production of constituent elements. For lead-acid (Pb/PbO₂) battery couples, several zinc-based couples, and many Li-ion technologies, less than 35 years' worth of material production is needed to store 10% of projected 2050 daily electricity demand. Sodium sulfur (NaS) technologies could store 55% of daily demand using less than eight months' worth of global sulfur production.

^{xv}To calculate storage capacity requirements as an average fraction of daily electricity demand in a 100% solar generation scenario, we start with data for hourly solar insolation and electricity demand profiles over a typical year in several U.S. cities and regional grids. We normalize the profiles such that the total insolation and electricity demand throughout the year are equal. Assuming that solar generation is proportional to insolation and no self-discharge occurs, the total energy that must be stored is equal to the sum of (insolation – demand) over daytime hours when the normalized insolation — i.e., solar production — exceeds demand. Dividing the total energy stored by the total demand gives the fraction of annual electricity that must be stored (55%). This fraction corresponds roughly to the daily fraction of energy stored, ignoring seasonal and day-to-day differences in daily insolation.

^{xvi}Supplementary information provided by Paul Albertus.⁵⁸

Figure 6.5 Materials Requirements for Large-Scale Deployment of Energy Storage Based on Various Electrochemical Battery Technologies

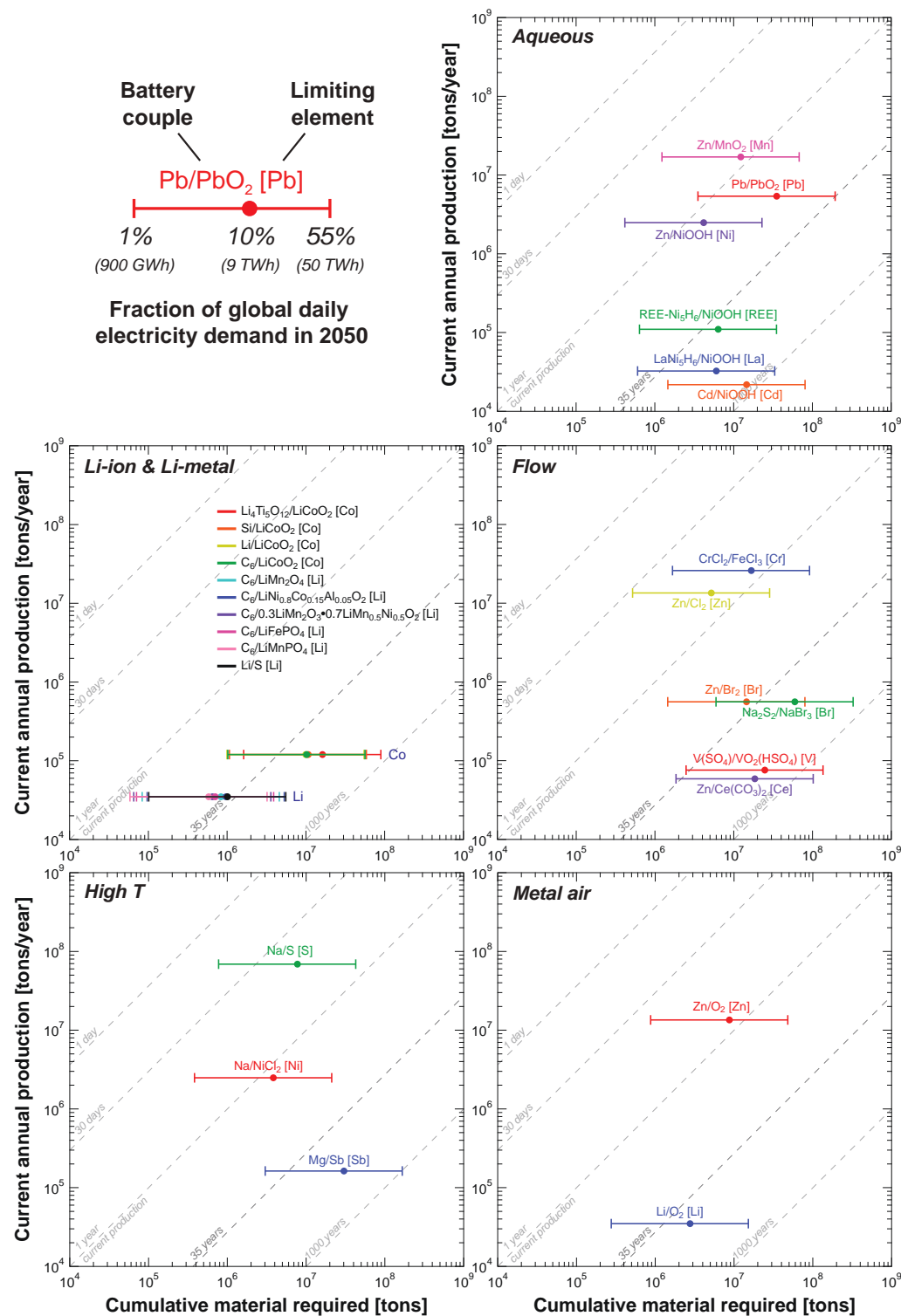

Note: Battery technologies considered here are described in more detail in Appendix C. This analysis considers only current annual production; relative crustal abundance also varies widely for the materials included in these charts. Analysis adapted from Wadia et al. Supplementary information provided by Paul Albertus.

There is no fundamental limit on the yearly production of these elements until cumulative production begins to approach crustal abundance. However, the economics of byproduction could put an effective limit on the rate of

With the exception of silver and silicon, all of the critical elements used in PV systems installed today are currently obtained as byproducts of the mining and refining of more abundant metals.

production of many PV-critical elements until the price of these elements increases enough to warrant primary mining and production. The next section discusses the economics of byproduction, which will likely determine the availability of many PV-critical elements for some time.

Byproduction

Most scarce elements are rarely found in concentrations high enough to warrant extraction as a primary product at today's prices: only a handful of rare elements, such as gold, the platinum group elements, and sometimes silver,

are so highly valued that they are mined as primary products. With the exception of silver and silicon, all of the critical elements used in PV systems installed today are currently obtained as byproducts of the mining and refining of more abundant metals. Table 6.2 summarizes data on the scale of annual production of these byproducts relative to their parent products.

Producing an element as a byproduct is typically much less expensive than producing the same element as a primary product. The costs of investment capital, mine planning, permitting, extraction, haulage, and several steps in the refining process are borne by the primary product. The byproduct accumulates at some stage in the refining process, and if its price exceeds the incremental cost of extracting it from other byproducts and purifying it, the byproduct is sent off for further processing at a secondary location. Even though a rare element may be relatively concentrated in the ores of several major metals (for example, tellurium is found in copper, zinc, and lead ores, among others) the market in many cases has settled on one principal source, either as a result of

Table 6.2 Production Volume and Monetary Value of PV-Critical Elements Produced as Byproducts, Relative to Parent Products

	Tellurium	Gallium	Indium	Selenium	Silver
Parent source	Copper	Aluminum	Zinc	Copper	Copper, lead, primary silver
Global production of parent in 2012 (10 ³ tons)	17,000	46,000	14,000	17,000	17,000 (copper)
Global production of byproduct in 2012 (10 ³ tons)	0.53	0.38	0.78	2.2	26 (silver)
Value of 2012 parent production (billion 2012\$)	140	100	28	140	140 (copper)
Value of 2012 byproduct production (billion 2012\$)	0.08	0.20	0.51	0.27	26 (from all sources)

mineralogical affinities or currently dominant refining technologies. Several aspects of joint production make the demand–price function for byproduced *energy-critical elements* (ECEs) volatile and difficult to predict:

Production ceiling – As shown in Table 6.2, the ECE market typically represents a minute fraction of the market for the primary metal. A demand-driven increase in the price of an ECE would initially be expected to spur increased recovery from the primary product stream. Once that recovery was optimized, however, ECE production could not be expanded further without increasing production of the primary product, which is unlikely in light of the current ratio of economic value between the primary product and the byproduct.^{xvii} If the price of the ECE rises to a sufficiently high level, primary production could eventually become economical and the roles of primary product and byproduct could switch. In that case, however, such a large increase in price would almost certainly preclude the use of the ECE in PV systems.

Changes in extraction technology – Economic or technical developments relating to the primary product may either increase or decrease recovery of the byproduct. For instance, in-situ leaching of copper ores, which increases copper yield but does not capture tellurium, is becoming more widespread and is replacing present electrolytic refining methods, which do capture tellurium. This development could result in a lower economical production ceiling for tellurium.

Several aspects of joint production make the demand–price function for byproduced energy-critical elements (ECEs) volatile and difficult to predict.

Price volatility – To satisfy increasing demand for an ECE after economical byproduction from the current source has been maximized, a new source for the ECE would have to be developed. Until the new byproduction stream comes online, the ECE will be expensive and in short supply. If demand and price continue to increase this cycle would repeat until, eventually, primary production would be the only way to accommodate growing demand. The price required to support primary production is difficult to estimate.

Some of these issues are summarized in the hypothetical cost/production function sketched in Figure 6.6. While neither the horizontal nor the vertical scale is specified, the vertical scale is labeled “logarithmic” to emphasize the magnitude of possible fluctuations. Understanding the cost versus production curves for ECEs in more depth and producing more realistic graphs for specific ECEs in particular should be a subject for future research.

^{xvii}As an example, in 2005 the U.S. Geological Survey (USGS) estimated that the total quantity of tellurium that could be recovered from electrolytic copper refining at present production rates was roughly 1,200 tons/year; yields typically range from 35% to 55% today, however, which further reduces the recoverable amount of tellurium. The most optimistic scenario we could find for future tellurium production predicts that worldwide primary production of tellurium (without recycling) will peak at roughly 3,200 tons/year in 2055 and decline thereafter.⁶⁰ Even if tellurium intensity falls with time, recycling from decommissioned PV modules cannot satisfy more than a fraction of exponentially growing demand from large-scale deployment.

Figure 6.6 Cost versus Production for a Hypothetical Energy-Critical Element

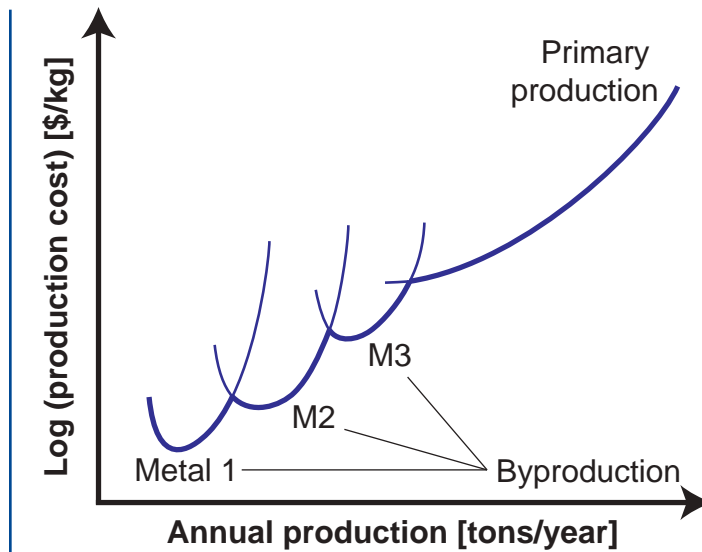

Note: Figure 6.6 shows a hypothetical cost versus production curve for an energy-critical element (ECE) that is initially obtained as a byproduct of major metal extraction. Each joint production curve shows an initial decrease as the new byproduction technology becomes established, followed by a plateau and a slow increase as rising production requires progressively more heroic efforts to capture the critical element, and finally a sharp increase when by production capacity is saturated. Eventually, primary production is the only remaining alternative, with a more conventional cost–production function.

The aggressive increase in annual PV deployment required to meet 50% or 100% of projected global electricity needs with PV would necessitate similarly aggressive growth in the production of certain materials.

Growth in Yearly Production [tons/year per year]

Just as there may be limits to the cumulative or yearly production of a material, there may also be limits to the rate at which production of this material can grow. The aggressive increase in annual PV deployment required to meet 50% or 100% of projected global electricity needs with PV would necessitate similarly aggressive growth in the production of certain materials (particularly materials that do not see wide use in other sectors, such as tellurium). Following the analysis method of Kavlak et al.^{61,62}

(presented in more detail in an associated white paper⁶³), we estimate the rate of growth in the production of PV-critical elements that is necessary to achieve these PV deployment targets and compare these growth rates with historical precedent. This analysis provides insight into the feasibility of terawatt-scale deployment of different PV technologies that employ these elements.

Figure 6.7 shows production data for 35 different metals over the last century.^{39,44} To determine the historical rate of growth in production as a function of time, we fit lines to the natural logarithm of production in overlapping 36-year periods (equal to the time remaining to achieve our 2050 deployment targets), using the slope to determine the annual growth rate over that period. We find that the median annual growth rate of production for these 35 metals over 36-year periods between 1900 and 2012 is

Figure 6.7 Historic Data on Production Growth for Different Metals Compared to Required Growth Rates for PV-Critical Elements

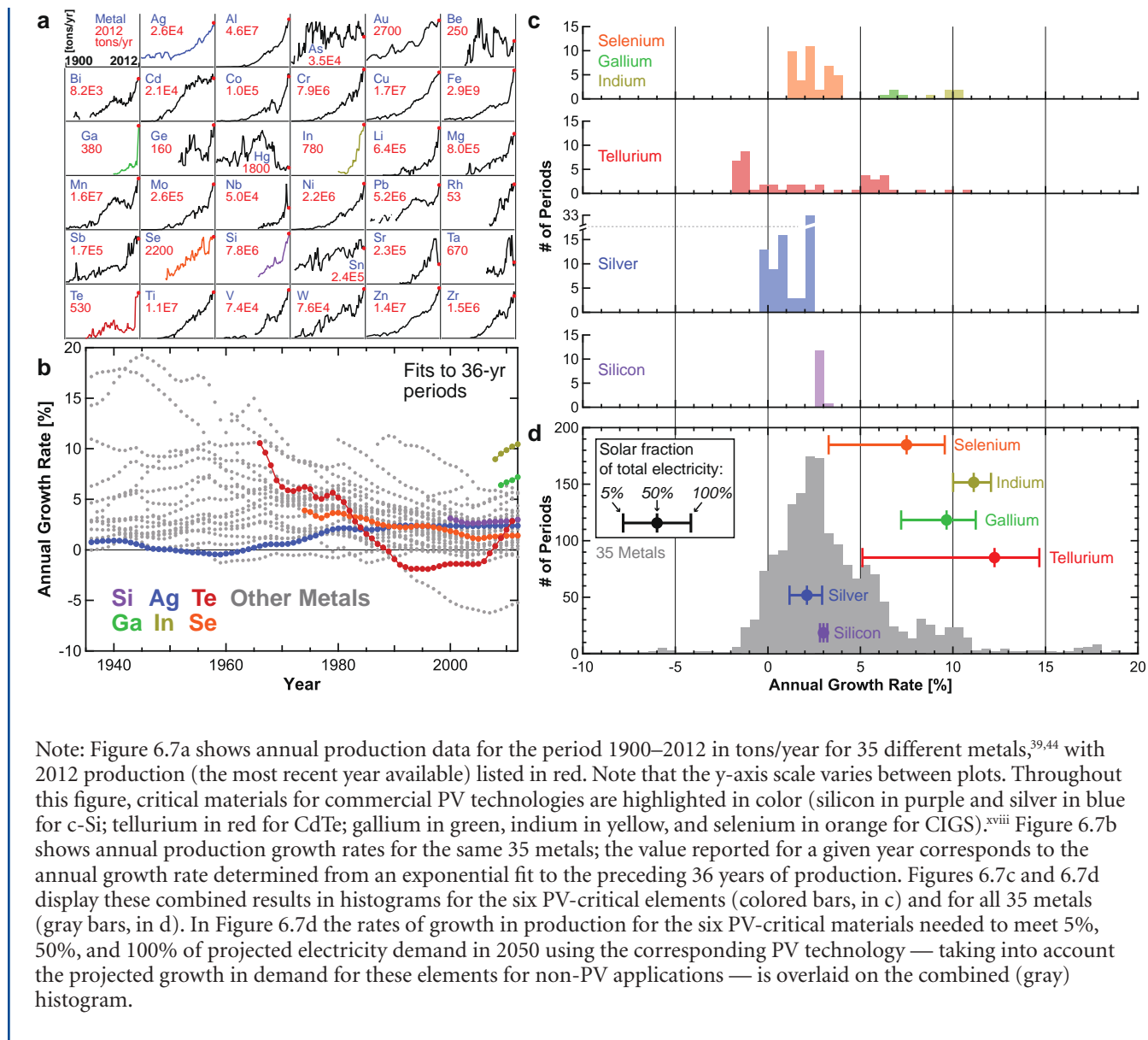

Note: Figure 6.7a shows annual production data for the period 1900–2012 in tons/year for 35 different metals,^{39,44} with 2012 production (the most recent year available) listed in red. Note that the y-axis scale varies between plots. Throughout this figure, critical materials for commercial PV technologies are highlighted in color (silicon in purple and silver in blue for c-Si; tellurium in red for CdTe; gallium in green, indium in yellow, and selenium in orange for CIGS).^{xviii} Figure 6.7b shows annual production growth rates for the same 35 metals; the value reported for a given year corresponds to the annual growth rate determined from an exponential fit to the preceding 36 years of production. Figures 6.7c and 6.7d display these combined results in histograms for the six PV-critical elements (colored bars, in c) and for all 35 metals (gray bars, in d). In Figure 6.7d the rates of growth in production for the six PV-critical materials needed to meet 5%, 50%, and 100% of projected electricity demand in 2050 using the corresponding PV technology — taking into account the projected growth in demand for these elements for non-PV applications — is overlaid on the combined (gray) histogram.

^{xviii}Unfortunately, data on present levels of tellurium production are fragmentary. The USGS Mineral Commodity Summaries^{39,44} stopped reporting world tellurium production in 2006 when non-U.S. world production was estimated to total nearly 130 tons/year (U.S. data were withheld starting in 1976 to avoid disclosing data proprietary to U.S. companies). Specific USGS *Minerals Yearbook* assessments estimated world (including U.S.) tellurium production at 450–500 tons/year for the period 2007–2010, 500–550 tons/year for 2011, and 550–600 tons/year for 2012. All reported data are included here; the 36-year fits used in our analysis smooth out the discontinuity.

2.8%. Out of 1,770 overlapping 36-year periods for the different metals, 26% of those 36-year periods showed annual growth rates above 5%, and only 5.8% showed growth rates above 10%. No 36-year periods with annual growth rates above 12% for a given metal have been witnessed for periods ending later than 1968. High 36-year average annual growth rates generally only occur near the onset of commercial production of a given metal, rather than after production has become well established.

Required growth rates for silicon and silver production fall well within the range of historical growth rates, even for 100% silicon PV penetration.

How do these historical rates of growth in production compare to the growth rates of PV-critical elements required to produce enough PV modules to supply a given percentage of projected world electricity demand by 2050? To answer this question we must account for demand from both the PV and non-PV sectors and make assumptions about how demand in both categories will change between now and 2050. As noted in the introduction to this chapter, roughly 25 TW_p of cumulative PV capacity would have to be installed to supply 100% of projected world electricity demand in 2050. By comparison, roughly 139 GW_p , or 0.139 TW_p , of PV capacity were installed worldwide by the end of 2013, with 39 GW_p installed during the 2013 calendar year.^{xix} In this analysis we assume the installation of PV modules with the same efficiency as current record-efficiency PV cells and utilize current

values for material intensity (measured in milligrams per watt of PV capacity [mg/W_p], or, equivalently, in tons per gigawatt [$tons/GW_p$]). Box 6.3 provides additional detail about the methodology and assumptions used in this analysis.

In Figure 6.7d, the required production growth rates for the six PV-critical elements for the 5%, 50%, and 100% PV penetration targets are compared to the histogram of historical growth rates for the 35 metals from Figures 6.7a,b. Very different trends are evident across the six PV-critical elements:

- Required growth rates for silicon and silver production fall well within the range of historical growth rates, even for 100% silicon PV penetration. Coupled with the fact that silicon is the second most abundant element in the earth's crust, our analysis indicates that there are no fundamental barriers to scaling up silicon production to the level necessary to achieve 100% PV penetration by mid-century. Silver's scarcity and cost imply that it is a more limiting material for silicon PV than silicon.^{xx}
- Between gallium, indium, and selenium, indium would require the highest rate of production growth to meet the PV capacity targets considered here: specifically, global indium production would have to grow at a rate of 11% and 12% annually to meet the 50% and 100% CIGS penetration targets, respectively. These levels of growth are rare among the 35 metals considered here, and

^{xix}A key feature of exponential (or compound annual) growth in production is that both annual production and the cumulative amount produced grow exponentially; in linear growth, annual production stays constant. The 5% PV penetration target in 2050 can be reached with constant annual production of PV modules ($39 \text{ } GW_p/\text{year} \times 36 \text{ years} = 1.4 \text{ } TW_p$); actual annual installation of PV worldwide has demonstrated a roughly 50% annual growth rate over the past 12 years, albeit from a very small initial value.⁴

^{xx}Copper is the intended substitute for silver in silicon PV, and is expected to mostly replace silver within the next decade.⁶

BOX 6.3 TECHNICAL NOTE ON GROWTH PROJECTIONS FOR CRITICAL ELEMENTS PRODUCTION

To account for demand for a given element from non-PV sectors, we assume that PV has historically been a negligible driver of production of this element, such that the median growth rate in production of this element (R_{hist}) reflects its response to demand from non-PV applications.^{xxi} To simplify the analysis we assume that R_{hist} is maintained as an average annual growth rate for non-PV demand between 2012 and 2050. Expected production for non-PV uses in 2050, P_{2050}^{non-PV} (tons/year), is then given by

$$P_{2050}^{non-PV} = P_{2012}^{non-PV} \times (1 + R_{hist})^{38},$$

where P_{2012}^{non-PV} is approximated as the entire reported production in 2012; that is, $P_{2012}^{non-PV} = P_{2012}^{total}$. We similarly assume that the total production of this element for PV and non-PV uses grows at a constant annual growth rate, such that

$$P_{2050}^{total} = P_{2050}^{non-PV} + P_{2050}^{PV} = P_{2012}^{non-PV} \times (1 + R_{required})^{38}.$$

We denote the cumulative production in tons between 2012 and 2050 for the PV- and non-PV-sectors as C_{2050}^{PV} and C_{2050}^{non-PV} , with $C_{2050}^{total} = C_{2050}^{PV} + C_{2050}^{non-PV}$ and

$$C_{2050}^{non-PV} = P_{2012}^{total} \frac{(1 + R_{hist})^{39} - 1}{R_{hist}};$$

$$C_{2050}^{total} = P_{2012}^{total} \frac{(1 + R_{required})^{39} - 1}{R_{required}}.$$

C_{2050}^{PV} is calculated from the desired 2050 capacity target [GW_p] as follows:

$$C_{2050}^{PV} = [\text{capacity target (GW}_p\text{)}] \times [\text{material intensity (tons/GW}_p\text{)}].$$

The values of the capacity target, material intensity, R_{hist} , and P_{2012}^{total} are all known, so $R_{required}$ may be calculated for each element.

have not been witnessed within the last 40 years. Even supplying just 5% of global electricity demand in 2050 with CIGS solar cells would require 10% annual growth in

indium production over the next 36 years, which is in the top 6% of historical growth rates demonstrated by the 35 metals considered here.^{xxii}

^{xxi}If the median historical growth rate of all 35 metals (2.8%) is used instead of the metal-specific historical growth rates, the resulting required growth rates for the 100% PV cases are changed by no more than $\pm 1\%$ in absolute terms for silicon, silver, tellurium, gallium, and selenium, and by -2.3% in absolute terms for indium.

^{xxii}The production of indium has grown rapidly in recent years in response to increasing demand from the consumer electronics industry, where it is used (in the form of indium tin oxide, or ITO) in the fabrication of flat-panel displays. Yet indium is also one of the least-produced metals considered here (at 780 tons/year it is 29th on our list of 35 metals), and given the potential complications with its status as a byproduced element, it may meet production limitations. Alternatives such as fluorine-doped tin oxide (FTO) are available to replace indium in transparent electrodes, and copper zinc tin sulfide (CZTS) is being explored as an alternative active material to CIGS.

- Tellurium would require the highest rate of production growth among the materials considered here, with 12% and 15% annual production growth required to meet the 50% and 100% CdTe penetration targets.

FINDING

The growth of silicon production necessary to supply even 100% of projected 2050 world electricity demand with PV falls well within historical levels. Silver is more limiting than silicon for silicon PV, and reducing or phasing out the use of silver should be a high priority for silicon PV research and development.

FINDING

Supplying even 5% of world electricity demand with cadmium telluride (CdTe) or copper indium gallium selenide (CIGS) solar cells would require directing today's entire worldwide production of key elements (tellurium, indium, and gallium) to PV fabrication. There is little historical precedent for the rates of growth in metal production that would be necessary to support higher levels of CdTe or CIGS penetration.

We note that growth rates reflect not only supply but also demand: if prices are relatively stable, demand will determine growth. Thus, low historical rates of growth in the production of a particular material do not necessarily imply that an unprecedented increase in demand for that material could not be met by a similarly unprecedented increase in supply. For example, molybdenum production grew by 19% annually between 1907 (when

molybdenum production totaled 91 tons) and 1943 (when molybdenum production totaled 31,600 tons); this rapid increase in production occurred in response to demand for molybdenum steel armor plating during World Wars I and II.⁶⁴ Such high growth rates in the production of specific metals are, however, rare outside the high demand levels present during wartime mobilization.

6.4 ADDRESSING MATERIAL SCALING LIMITS

As discussed in the foregoing sections, our analysis suggests that silicon does not face any fundamental limits in terms of cumulative production, yearly production, or growth in production even if silicon-based solar cells are used to meet 100% of projected global electricity demand by 2050. Silver faces intermediate

The cost of silver already adds to silicon PV module costs significantly.

constraints in some of these areas, and tellurium, indium, gallium, and selenium each face more severe constraints. We next consider approaches to mitigating potential limits to the scaling of materials production for large-scale PV deployment: first, by decreasing the material intensity of presently-used elements, and second, by developing presently emerging thin-film technologies that make use of more abundant and widely-produced elements.

Decreased Material Intensity

Silver

The cost of silver already adds to silicon PV module costs significantly: silver accounts for approximately 10% of the non-silicon cell cost, and 5%–10% of the world's new silver production is already being used for PV manufacturing.^{6,39} The International Technology Roadmap for

Figure 6.8 Total Consumption of Critical Materials for Commercial PV Technologies as a Function of Total Deployment

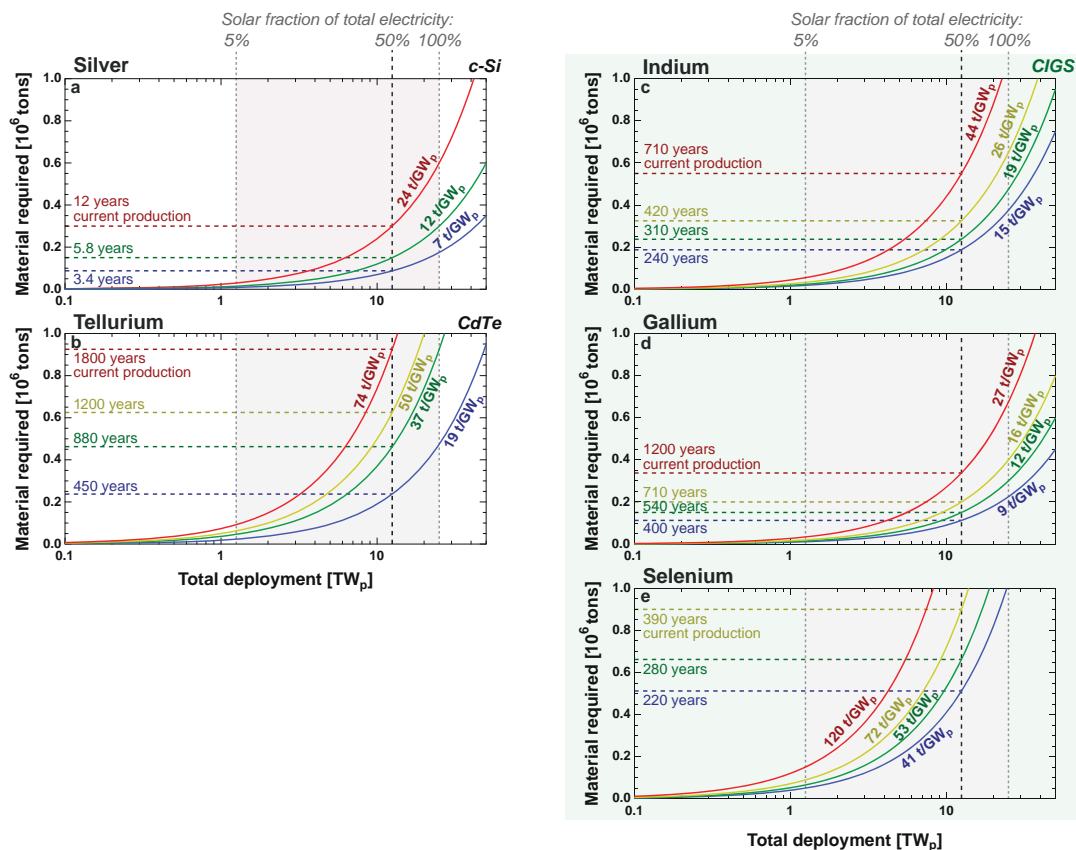

Note: Current material intensities are designated by the red curves, and various projected values for material intensity (tons/GW_p) are shown for silver (Ag) for c-Si PV (a),⁶ tellurium (Te) for CdTe (b),⁶⁵ and indium, gallium, and selenium (In, Ga, and Se) for CIGS (c-e).⁶⁰ Future material intensities are calculated from known densities and relative mass fractions of the relevant elements, along with estimated materials utilization (90% for Te;⁶⁵ 34% for In, Ga, and Se⁶⁰), projected active layer thicknesses, and projected power conversion efficiencies.^{xxiii} Annual production data for each element are from the U.S. Geological Survey (USGS).^{39,44} For the 50% solar PV case (dashed vertical lines; 12.5 TW_p total deployment), we indicate the number of years of current material production required to deploy each PV technology given different material intensity values.

Photovoltaic 2014 Report (ITRPV)⁶ envisions silver intensity decreasing from 24 tons/GW_p today to approximately 7 tons/GW_p by 2024. As shown in Figure 6.8a, if silver intensity were reduced to the ITRPV predicted value of 7 tons/GW_p, continued production of silver at the present rate would supply sufficient silver

to enable 50% PV penetration within 3.4 years if all silver production were used for PV manufacture. In other words, if total silver production persisted at present levels, the silver required for 50% PV penetration in 2050 would make up 9.4% of overall silver production for the next 35 years. We conclude that the

^{xxiii}We note that the data in Figure 6.8, following the analysis in ITRPV,⁶ Woodhouse et al.,⁶⁵ and Fthenakis,⁶⁰ reflect assumptions based on module efficiencies; Figures 6.4 and 6.7 utilize record cell efficiencies and are therefore more optimistic.

reduction of silver intensity or the substitution of a more abundant element (such as copper, which is the PV industry's intended substitute) in c-Si PV cells should be a high research priority.

CdTe

The situation for tellurium in CdTe thin-film PV is not as favorable as the situation for silicon and silver in c-Si PV. Figure 6.8b shows scenarios for CdTe deployment assuming different potential tellurium intensities. Unless tellurium intensity can be decreased even beyond today's optimistic projections and/or unless a major and unanticipated new supply of tellurium emerges, deployment of CdTe solar cells at a level sufficient to meet a large fraction of electricity demand in 2050 may be out of reach, even if 100% of the world's tellurium output from known sources were directed toward PV fabrication. Of course, at a much lower rate of deployment — as might be appropriate if CdTe were only one component of a suite of PV technologies — tellurium supplies would not be a constraint.

CIGS

Materials supply prospects for large-scale deployment of CIGS PV fall somewhere between the prospects for c-Si and CdTe deployment. Figures 6.8c-e show demand for indium, gallium, and selenium, respectively, as a function of proposed deployment and material intensity. It should be noted that since

all three elements are necessary components of CIGS solar cells, the deployment of this technology would be limited by the element with the lowest production. Since gallium has the lowest material intensity and is most abundant among the CIGS critical elements, it is not likely to be the limiting element in CIGS deployment. Selenium is least abundant and has the highest material intensity among the CIGS materials, but it is also unlikely to be the element that limits CIGS deployment as it currently costs least and is produced in the greatest volume. More importantly, selenium has important byproduction sources that are currently underutilized, suggesting that its production could be substantially increased without significant increases in cost.^{xxiv} Several arguments suggest that indium could be the limiting component in potential large-scale CIGS deployment: (1) the ratio of indium to gallium in CIGS solar cells is roughly four to one (4:1) by weight;⁶⁶ (2) indium is roughly one one-hundredth (1/100th) as abundant as gallium in the earth's crust; (3) indium is already recovered with relatively high efficiency from zinc and other metal ores; and (4) demand for indium as a component in indium-tin-oxide (ITO) transparent conducting films for the flat-panel-display industry is high. Efforts are underway to find an Earth-abundant substitute for ITO — if successful, these efforts would reduce competition for indium from non-CIGS applications.^{67,68} In addition, recycling ITO from the existing stock of flat-panel displays would provide a potential source of indium for PV applications.

^{xxiv}Selenium is obtained principally as a byproduct of copper production, where it is five to seven times more abundant than tellurium. Selenium is also abundant in coal, especially high-sulfur coal, and is enriched in coal ash by an order of magnitude. A dramatic increase in the price of selenium — which would still be compatible with its use in CIGS solar cells given its current order-of-magnitude lower cost than indium — could stimulate selenium recovery from coal. Selenium's relative abundance in copper and the potential for selenium recovery from coal make it unlikely that the availability of this element would act as the limiting constraint on large-scale CIGS deployment.

Alternative Active Materials

For some of the commercial PV technologies discussed previously, the reductions in material intensity that would be required to enable large-scale deployment may be prohibitive given physical and practical limits on layer thicknesses. For example, thinner films may be unable to absorb sunlight fully, or may facilitate the development of short circuits in large-area devices. Avoiding scarce elements altogether would thus be desirable. Many emerging thin-film PV technologies have lower material requirements than the commercial technologies discussed in this chapter and use only Earth-abundant elements.

Returning to Figure 6.4, a stark contrast arises between material requirements for commercial and emerging thin-film PV technologies. Colloidal quantum dot (QD) PV provides a case in point: to deploy 25 TW_p of lead sulfide QD solar cells would require the equivalent of only 23 days of global lead production and 7 hours of global sulfur production. This disparity can be attributed to the use of abundant, high-production-volume primary metals and ultra-thin absorber layers in emerging

Many emerging thin-film PV technologies have lower material requirements than the commercial technologies discussed in this chapter and use only Earth-abundant elements.

thin-film technologies. Perovskite, copper zinc tin sulfide (CZTS), organic, and dye-sensitized solar cells (DSSC) employ elements that are similarly produced in abundant quantities. As discussed in Chapter 2, the potential for

emerging thin-film technologies to achieve high power per unit weight and their compatibility with thin, flexible substrates may also reduce BOS commodity material requirements. However, low efficiencies, poor stability, and the current absence of module-scale demonstrations currently limit the economic practicality of these emerging technologies, making them important targets for further research.

FINDING

Emerging thin-film technologies (e.g., CZTS, perovskite, DSSC, organic, and QD) are better positioned for ambitious scale-up than commercial thin-film technologies (CdTe and CIGS) in terms of materials availability. However, further research is required to overcome efficiency, stability, and manufacturing limitations before emerging thin-film technologies can be considered suitable for large-scale deployment.

It should be emphasized, however, that no single PV technology is likely to capture 100% of the PV market. Commercial thin-film technologies could avoid critical material constraints and remain commercially viable at a deployment scale of up to hundreds of gigawatts by 2050. Furthermore, emerging thin films have not reached the manufacturing scale needed to permit accurate estimation of materials use, materials utilization yield, and manufacturing yield in high-volume module production.

Materials scaling considerations may be a deciding factor in determining which specific PV technologies fulfill the majority of PV demand in the coming decades.

6.5 CONCLUSION

The production of commodity materials used in the fabrication of PV modules and the availability of suitable land area for PV installations are unlikely to be limiting factors in the scaling of PV deployment. However, materials scaling considerations may be a deciding factor in determining which specific PV technologies fulfill the majority of PV demand in the coming decades. If the use of silver for electrical contacts can be reduced or eliminated, silicon PV faces no fundamental materials supply constraints in terms of its ability to meet a large fraction of global electricity demand in 2050. Emerging thin-film technologies based on Earth-abundant elements have not yet been demonstrated at module scale with efficiencies and lifetimes high enough to be economically practical; if these challenges can be overcome,

materials availability would not pose a significant barrier to scale-up for these technologies. Current commercial thin-film technologies would need to demonstrate dramatic reductions in active material intensity to fulfill a large fraction of electricity demand. Given the optimistic outlook on materials availability for conventional silicon PV technologies, the difficulties inherent in turning the intermittent output of PV installations into a reliable and dispatchable source of electric power are likely to constitute the more important constraint on large-scale PV deployment in the future. These system integration constraints are the focus of the next chapter.

The difficulties inherent in turning the intermittent output of PV installations into a reliable and dispatchable source of electric power are likely to constitute the more important constraint on large-scale PV deployment in the future.

REFERENCES

- ¹PVPS Report: Snapshot of Global PV 1992-2013, International Energy Agency. (2014). http://www.iea-pvps.org/fileadmin/dam/public/report/statistics/PVPS_report_-_A_Snapshot_of_Global_PV_-_1992-2013_-_final_3.pdf
- ²Article 2 of the United Nations Framework Convention on Climate Change, United Nations. (1992). <http://unfccc.int/resource/docs/convkp/conveng.pdf>
- ³Hoffert, M.I., K. Caldeira, A.K. Jain, et al., "Energy Implications of Future Stabilization of Atmospheric CO₂ Content." *Nature* 395, (1998): 881–884. <http://dx.doi.org/10.1038/27638>
- ⁴Global Market Outlook for Photovoltaics 2014-2018, European Photovoltaic Industry Association. (2014). http://www.epia.org/fileadmin/user_upload/Publications/EPIA_Global_Market_Outlook_for_Photovoltaics_2014-2018_-_Medium_Res.pdf
- ⁵Jean, J., P.R. Brown, R.L. Jaffe, T. Buonassisi, and V. Bulovic. "Pathways for Solar Photovoltaics." *Energy & Environmental Science* 8, no. 4 (2015): 1200–1219. <http://dx.doi.org/10.1039/C4EE04073B>
- ⁶International Technology Roadmap for Photovoltaic 2013 Results, ITRPV. (2014). <http://www.itrpv.net/Reports/Downloads/2014/>
- ⁷World Energy Outlook 2006, International Energy Agency. (2006). <http://www.worldenergyoutlook.org/media/weowebiste/2008-1994/WEO2006.pdf>
- ⁸World Energy Outlook 2008, International Energy Agency. (2008). <http://www.worldenergyoutlook.org/media/weowebiste/2008-1994/weo2008.pdf>
- ⁹World Energy Outlook 2009, International Energy Agency. (2009). <http://www.worldenergyoutlook.org/publications/weo-2009/>
- ¹⁰World Energy Outlook 2010, International Energy Agency. (2010). <http://www.worldenergyoutlook.org/publications/weo-2010/>
- ¹¹World Energy Outlook 2011, International Energy Agency. (2011). <http://www.worldenergyoutlook.org/publications/weo-2011/>
- ¹²World Energy Outlook 2012, International Energy Agency. (2012). <http://www.worldenergyoutlook.org/publications/weo-2012/>
- ¹³World Energy Outlook 2013, International Energy Agency. (2013). <http://www.worldenergyoutlook.org/publications/weo-2013/>
- ¹⁴World Energy Outlook 2014, International Energy Agency. (2014). <http://www.worldenergyoutlook.org/publications/weo-2014/>
- ¹⁵International Energy Outlook 2010, U.S. Energy Information Administration. (2010). <http://www.eia.gov/forecasts/archive/ieo10/index.html>
- ¹⁶International Energy Outlook 2011, U.S. Energy Information Administration. (2011). <http://www.eia.gov/forecasts/archive/ieo11/>
- ¹⁷International Energy Outlook 2013, U.S. Energy Information Administration. (2013). [http://www.eia.gov/forecasts/ieo/pdf/0484\(2013\).pdf](http://www.eia.gov/forecasts/ieo/pdf/0484(2013).pdf)
- ¹⁸International Energy Outlook 2009, U.S. Energy Information Administration. (2009). [http://www.eia.gov/forecasts/archive/ieo09/pdf/0484\(2009\).pdf](http://www.eia.gov/forecasts/archive/ieo09/pdf/0484(2009).pdf)
- ¹⁹IHS, "Solar Installations to Rise 20 Percent in 2014, Thanks to Strong Fourth Quarter." (2014): <http://press.ihs.com/press-release/design-supply-chain/solar-installations-rise-20-percent-2014-thanks-strong-fourth-quar>
- ²⁰Renewable 2014 Global Status Report, Renewable Energy Policy Network for the 21st Century (REN21). (2014): http://ren21.net/Portals/0/documents/Resources/GSR/2014/GSR2014_full%20report_low%20res.pdf
- ²¹Jacobson, M.Z., and M.A. Delucchi, "Providing All Global Energy with Wind, Water, and Solar Power, Part I: Technologies, Energy Resources, Quantities and Areas of Infrastructure, and Materials." *Energy Policy* 39 (2011): 1154–1169. <http://dx.doi.org/10.1016/j.enpol.2010.11.040>
- ²²2007 Working Group III: Stabilization Scenarios, Intergovernmental Panel on Climate Change. (2007): http://www.ipcc.ch/publications_and_data/ar4/wg3/en/tssts-ts-3-2-stabilization-scenarios.html
- ²³Meinshausen, M., N. Meinshausen, W. Hare, et al., "Greenhouse-Gas Emission Targets for Limiting Global Warming to 2 Degrees C." *Nature* 458 (2009): 1158–62. <http://dx.doi.org/10.1038/nature08017>
- ²⁴Energy Technology Perspectives 2014, International Energy Agency. (2014). <http://www.iea.org/etp/etp2014/>
- ²⁵Photovoltaics Report 2014, Fraunhofer Institute for Solar Energy Systems. (2014). <http://www.ise.fraunhofer.de/de/downloads/pdf-files/aktuelles/photovoltaics-report-in-englischer-sprache.pdf>

- ²⁶*Utility-Scale Energy Technology Capacity Factors*, U.S. National Renewable Energy Laboratory, (2013): http://www.nrel.gov/analysis/tech_cap_factor.html
- ²⁷Patzek, T.W., “Thermodynamics of the Corn-Ethanol Biofuel Cycle.” *Critical Reviews in Plant Sciences* 23 (2004): 519–567. <http://dx.doi.org/10.1080/07352680490886905>
- ²⁸*How Much Ethanol Is in Gasoline and How Does It Affect Fuel Economy?*, U.S. Energy Information Administration. (2014): <http://www.eia.gov/tools/faqs/faq.cfm?id=27&t=4>
- ²⁹*The Footprint of Coal*, SourceWatch. (2011): http://www.sourcewatch.org/index.php/The_footprint_of_coal
- ³⁰*Hodel v. Indiana*, 452 U.S. 314. (1981): <http://caselaw.lp.findlaw.com/scripts/getcase.pl?navby=cas&court=us&vol=452&invol=314>
- ³¹*Annual Reports*, Office of Surface Mining Reclamation and Enforcement. (2014): <http://www.osmre.gov/resources/annualreports.shtm>
- ³²Denholm, P., and R.M. Margolis, “Land-Use Requirements and the per-Capita Solar Footprint for Photovoltaic Generation in the United States.” *Energy Policy* 36 (2008): 3531–3543. <http://dx.doi.org/10.1016/j.enpol.2008.05.035>
- ³³*Highway Statistics 2005, Section V: Roadway Extent, Characteristics, and Performance*, U.S. Department of Transportation Federal Highway Administration. (2005): http://www.fhwa.dot.gov/policy/ohim/hs05/roadway_extent.htm
- ³⁴Nickerson, C., R. Ebel, A. Borchers, and F. Carriazo, “Major Uses of Land in the United States, 2007.” *United States Department of Agriculture - Economic Research Service* (2011): <http://www.ers.usda.gov/data-products/major-land-uses.aspx>
- ³⁵*About Us*, National Park Service. (2015): <http://www.nps.gov/aboutus/index.htm>
- ³⁶*About the Department of Defense*, U.S. Department of Defense. (2015): www.defense.gov/about/
- ³⁷*Does the World Have Enough Materials for PV to Help Address Climate Change?*, U.S. National Renewable Energy Laboratory. (2005): <http://www.nrel.gov/docs/fy05osti/37656.pdf>
- ³⁸*Plastic Resins in the United States 2013*, American Chemistry Council. (2013): <http://www.packaginggraphics.net/plasticResinInformation/Plastics-Report.pdf>
- ³⁹*Historical Statistics for Mineral and Material Commodities in the United States*, U.S. Geological Survey. (2014): <http://minerals.usgs.gov/minerals/pubs/historical-statistics/>
- ⁴⁰*World Flat Glass - Industry Study with Forecasts*, Freedonia Group. (2013): <http://www.freedoniagroup.com/brochure/29xx/2970smwe.pdf>
- ⁴¹*Cement & Concrete: Key Facts & Figures*, The European Cement Association. (2014): <http://www.cembureau.eu/about-cement/key-facts-figures>
- ⁴²Parker, D.T., *Building Victory: Aircraft Manufacturing in the Los Angeles Area in World War II*, Cypress, CA, 2013.
- ⁴³Lide, D.R., *CRC Handbook of Chemistry and Physics, 85th Edition*, CRC Press, Boca Raton, Florida, 2005.
- ⁴⁴Commodity Statistics and Information, U.S. Geological Survey. (2014): <http://minerals.usgs.gov/minerals/pubs/commodity/>
- ⁴⁵Andersson, B.A., C. Azar, J. Holmberg, and S. Karlsson, “Material Constraints for Thin-Film Solar Cells.” *Energy* 23 (1998): 407–411. [http://dx.doi.org/10.1016/S0360-5442\(97\)00102-3](http://dx.doi.org/10.1016/S0360-5442(97)00102-3)
- ⁴⁶Feltrin, A., and A. Freundlich, “Material Challenges for Terawatt Level Deployment of Photovoltaics.” *Renewable Energy* 33 (2008): 180–185. <http://dx.doi.org/10.1109/WCPEC.2006.279727>
- ⁴⁷Green, M.A., “Estimates of Te and In Prices from Direct Mining of Known Ores.” *Progress in Photovoltaics: Research and Applications* 17 (2009): 347–359. <http://dx.doi.org/10.1002/pip.899>
- ⁴⁸Zweibel, K., “The Impact of Tellurium Supply on Cadmium Telluride Photovoltaics.” *Science* 328 (2010): 699–701. <http://dx.doi.org/10.1126/science.1189690>
- ⁴⁹Wadia, C., A.P. Alivisatos, and D.M. Kammen, “Materials Availability Expands the Opportunity for Large-Scale Photovoltaics Deployment.” *Environmental Science and Technology* 43 (2009): 2072–2077. <http://dx.doi.org/10.1021/es8019534>
- ⁵⁰Jaffe, R., J. Price, G. Ceder, et al., “Energy Critical Elements: Securing Materials for Emerging Technologies.” (2011): <http://www.aps.org/policy/reports/popa-reports/upload/elementsreport.pdf>
- ⁵¹*Minerals, Critical Minerals, and the U.S. Economy*, National Resource Council. (2008). <http://www.nap.edu/catalog/12034/minerals-critical-minerals-and-the-us-economy>

- ⁵²*Critical Materials Strategy*, U.S. Department of Energy. (2011): http://energy.gov/sites/prod/files/DOE_CMS2011_FINAL_Full.pdf
- ⁵³Kaye, G.W.C., and T.H. Laby, *Abundances of the Elements*, in: *Tables of Physical & Chemical Constants*, National Physical Laboratory, 1995. www.kayelaby.npl.co.uk
- ⁵⁴Earnshaw, A., and N. Greenwood, *Abundance of Elements in Crustal Rocks*, in: *Chemistry of the Elements*, 2nd ed., 1997.
- ⁵⁵Taylor, S.R., and S.M. McLennan, *The Continental Crust: Its Composition and Evolution*, Blackwell Sci. Publ., Oxford, 1985.
- ⁵⁶Wänke, H., G. Dreibus, and E. Jagoutz, *Mantle Chemistry and Accretion History of the Earth*, in: A. Kroener, G.N. Hanson, A.M. Goodwin (Eds.), *Archaeo Geochemistry*, Springer-Verlag, Berlin, 1984.
- ⁵⁷Weaver, B.L., and J. Tamey, *Major and Trace Element Composition of the Continental Lithosphere*, in: H.N. Pollack, V.R. Murthy (Eds.), *Physics and Chemistry of the Earth*, Pergamon, Oxford, 1984.
- ⁵⁸Wadia, C., P. Albertus, and V. Srinivasan, "Resource Constraints on the Battery Energy Storage Potential for Grid and Transportation Applications." *Journal of Power Sources* 196 (2011): 1593–1598. <http://dx.doi.org/10.1016/j.jpowsour.2010.08.056>
- ⁵⁹*Mineral Commodity Summaries*, U.S. Geological Survey. (2014): <http://minerals.usgs.gov/minerals/pubs/mcs/>
- ⁶⁰Fthenakis, V., "Sustainability of Photovoltaics: The Case for Thin-Film Solar Cells." *Renewable and Sustainable Energy Reviews* 13 (2009): 2746–2750. <http://dx.doi.org/10.1016/j.rser.2009.05.001>
- ⁶¹Kavlak, G., J. Mcnerney, R.L. Jaffe, and J.E. Trancik, "Growth in Metals Production for Rapid Photovoltaics Deployment." *Proceedings of the 40th IEEE Photovoltaic Specialists Conference* (2014): 1442. <http://mitei.mit.edu/futureofsolar>
- ⁶²Kavlak, G., J. McNerney, R.L. Jaffe, and J.E. Trancik, "Metals Production Requirements for Rapid Photovoltaics Deployment." *Arxiv Preprint* (2014): <http://arxiv.org/pdf/1501.03039.pdf>
- ⁶³Kavlak, G., J. McNerney, R.L. Jaffe, and J.E. Trancik, "Metals Production Requirements for Rapid Photovoltaics Deployment." *MIT Energy Initiative Working Paper* (2015): <http://dx.doi.org/10.1109/PVSC.2014.6925187>
- ⁶⁴Emsley, J., *Nature's Building Blocks*, Oxford University Press, Oxford, 2001.
- ⁶⁵Woodhouse, M., A. Goodrich, R. Margolis, et al., "Perspectives on the Pathways for Cadmium Telluride Photovoltaic Module Manufacturers to Address Expected Increases in the Price for Tellurium." *Solar Energy Materials & Solar Cells* 115 (2013): 199–212. <http://dx.doi.org/10.1016/j.solmat.2012.03.023>
- ⁶⁶Kemell, M., M. Ritala, and M. Leskelä, "Thin Film Deposition Methods for CuInSe₂ Solar Cells." *Critical Reviews in Solid State and Materials Sciences* 30 (2005): 1–31. <http://dx.doi.org/10.1080/10408430590918341>
- ⁶⁷Minami, T., "Transparent Conducting Oxide Semiconductors for Transparent Electrodes." *Semiconductor Science and Technology* 20 (2005): S35–S44. <http://dx.doi.org/10.1088/0268-1242/20/4/004>
- ⁶⁸Hecht, D.S., L. Hu, and G. Irvin, "Emerging Transparent Electrodes Based on Thin Films of Carbon Nanotubes, Graphene, and Metallic Nanostructures." *Advanced Materials* 23 (2011): 1482–1513. <http://dx.doi.org/10.1002/adma.201003188>

The hyperlinks in this document were active as of April 2015.



Chapter 7 – Integration of Distributed Photovoltaic Generators

This chapter explores the technical and economic effects that large amounts of distributed photovoltaic (PV) generation can have on the electricity distribution network. Intermittent distributed generation (DG) affects power flow patterns in the grid, causing various well-documented (and predominantly local) problems that may require significant network upgrades and modifications. Building on previous studies and using a model-based approach, we discuss the aggregate economic effect that different levels of PV penetration (expressed as a share of overall generation) would have over several types of networks in different geographic locations and the implications of these effects for tariff design. We also discuss how distributed energy storage can contribute to the cost-effective integration of PV resources.

Section 7.1 describes, in general terms, issues related to the integration of PV generation at the distribution level and reviews international experience. Section 7.2 reviews basic concepts related to distributed generation that are useful for understanding the remaining sections. Section 7.3 explains the methodology used to estimate the aggregate economic impact of PV generators and the value of energy storage as an alternative to network reinforcements or upgrades. Section 7.4 presents and discusses results from the simulations. Conclusions and recommendations are presented in Section 7.5.

7.1 INTRODUCTION

The number of grid-connected, distributed PV generators has exploded in the last decade in the United States and abroad,^{1,2} imposing new operational requirements on networks that were designed to passively allow for the flow of electric power from large generation facilities to

end-use consumers. Of the nearly 70 gigawatts (GW) of nameplate PV capacity installed in Europe by 2013, it is estimated that 96% is connected to the distribution network in either medium voltage or low voltage, with the size of typical systems ranging from a few kilowatts peak (kW_p) in low voltage up to 5 megawatts (MW_p) in medium voltage.² Of the approximately 18 GW of installed PV capacity in the

The number of grid-connected, distributed PV generators has exploded in the last decade in the United States and abroad.

United States, 45% corresponds to generators under 1 MW (see Chapter 4). This concentration of PV generation in the lower voltage levels is the motivation for studying PV's economic impact on distribution systems.

Distributed PV generators represent a particular type of *variable* (or *intermittent*) energy resource, with three characteristics that set them apart from traditional generators. First, distributed PV generators are *dispersed*, meaning that a given amount of installed capacity is spread over numerous devices scattered across a large geographic area; second, their power output is *variable* because of the solar cycle and clouds; and third, their power output is *uncertain* because although the amount of sunlight reaching the PV array follows a regular pattern on average, chaotic atmospheric changes account for large deviations that are difficult to predict.³ These characteristics explain why, as the results presented in this chapter bear out, a distribution network with a substantial amount of distributed PV generation is more expensive than one that primarily serves loads, under current engineering practices.

Findings from several studies,^{4,5,6,7,8} field experience, and forecasts⁹ support the existence of cost drivers associated with distributed PV for many particular cases. They also point to the need for new analysis tools^{10,11,12} and for a revision of the methods used to calculate the allowed remuneration of distribution companies,²⁰ as well as for new methods to calculate network charges to the users of distribution infrastructure.^{13,14,15,21} Studies published to date have analyzed the problem either by looking at a few characteristic feeders (i.e., lines and other infrastructure that connect distribution substations to distribution network users) or by surveying stakeholders.

Quantifiable parameters, like the maximum theoretical hosting capacity of a feeder and information on actual costs incurred by utilities, provide valuable data points to guide policy decisions. However, cost causality relationships are difficult to determine. For this reason, and also because it is a widely accepted practice to apply the same tariff to all consumers connected to low voltage levels, most retail electricity customers pay a network tariff that is calculated by averaging across a wide collection of facilities. The relationship between significant PV penetration in some locations and required investments to address related grid impacts and maintain quality of service is also important.

This chapter discusses the link between the presence of PV generation in distribution networks and all the costs related to the power distribution function from an aggregate point of view. A model-based approach is used to explore and illustrate this relationship for a range of different network types and locations.

7.2 KEY CONCEPTS

The purpose of this section is to provide basic background and terminology for the discussion that follows.

Electricity Transmission and Distribution Networks

Network infrastructure enables the existence of interconnected electric power systems (EPSs); this infrastructure includes cables, transformers, protections, towers, and insulators that allow power to flow from sources (generators) to sinks (loads). Loads are not uniformly distributed over the landscape, but cluster in cities, industrial parks, villages, etc. Although the first EPSs served single clusters, engineers realized early on that interconnecting load clusters makes it possible to exploit economies of scale in generation, and also to increase the reliability of service. The distribution (intra-cluster) and transmission (inter-cluster) segments of the electricity network are different in architecture and function:

- The transmission network is characterized by lines that allow for the flow of large amounts of power over long distances.
- The distribution network features shorter lines and smaller power flows. Since it has to connect every final customer, the number of lines and other infrastructure assets is much larger than in the transmission network (for a given region, if the number of transmission assets is several hundreds, the distribution company can easily manage many thousands).

From a regulatory perspective, both parts of the network are considered natural monopolies because duplicating the infrastructure needed to deliver electricity would significantly increase the total cost of providing electricity service. To prevent market power abuse, the company that owns the infrastructure has to be treated as a regulated monopoly, to make sure that it provides good service at a fair price. Typically, the regulator determines how much revenue the company is allowed to collect based on the cost of providing the service efficiently. In areas with widely dispersed demand, lines

are longer and serve fewer customers than in dense cities. Also, for historical reasons, different countries have adopted a variety of grid design and operating standards. This chapter examines differences between the predominant practices in Europe and the United States to explore how they affect the potential impact of large quantities of distributed PV generation:

- In the United States the medium voltage (MV) network (usually 4 or 12 kilovolts) dominates the landscape and low voltage (LV) lines cover only the last tens of meters to customers. In Europe, by contrast, the LV network has a higher voltage and extends much further.
- Distribution networks in the United States and Europe use different voltage levels.
- In Europe, most distribution lines are triphasic, while in the United States these lines frequently coexist with single and biphasic configurations.¹

- Overhead power lines are common in the United States, even in some densely populated areas, while in Europe urban distribution networks are typically underground.

Load and Generation Profiles

The utilization of network equipment on the electricity grid continuously fluctuates because both load and generation profiles are intimately tied to a changing environment as well to the behavior of people. Thus, the network designer has to take into account *when* and *where* power will be consumed or withdrawn in order to size equipment and decide how to group users in the design of the network. For example, if ten consumers with the profile in Figure 7.1a are connected to the same distribution transformer, the device will need to be able to cope with ten times the nominal maximum load of each consumer. However, if the distribution company connects five type (a) loads with another five type (b) loads, it can reduce the size of the transformer by about 30%.

Figure 7.1 Examples of Load Profiles

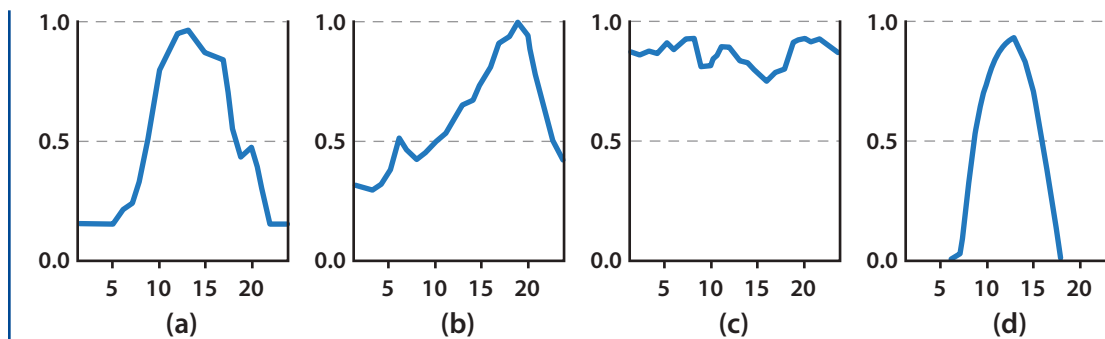

Note: Load profiles are shown for (a) commercial, (b) residential, and (c) industrial customers. Figure 7.1d shows an ideal generation profile for a PV facility. All values are expressed as a fraction of annual maximum load (or generation in the case of Figure 7d). In each graph, hours of the day are shown on the horizontal axis.

¹Depending on the magnitude of power, distances involved, and voltage level, between two and four conductors can be used to carry electricity. For more than two wires, the voltage waveforms between different pairs have a different phase, which means they are displaced in time.

When PV generators are integrated, some customers who were previously only consumers of electricity may now, at times, inject power back into the network, becoming *prosumers*. Now the network designer has to make sure

Regardless of the coincidence between patterns of demand and solar generation on average, high levels of PV penetration pose challenges for the distribution system operator and impose costs on the network, which must continue to provide reliable, quality service in all scenarios.

that the network can maintain quality of service in two critical scenarios: one for generation and another for demand. As an example, Figure 7.2a shows load, PV generation, and net load for a single commercial customer on a day when the customer’s PV system produces a maximum negative net load on the system — in other words, there is a reverse flow of power from this customer back to the grid during the

midday hours, when the customer’s electricity use is low and the output from his PV system is high. Figure 7.2b shows the other extreme: in this scenario, peak PV generation does not coincide with peak demand and the customer imposes a maximum (positive) net load on the system during hours when his electricity use is high and output from his PV system is negligible. Regardless of the coincidence between patterns of demand and solar generation on average, high levels of PV penetration pose challenges for the distribution system operator and impose costs on the network, which must continue to provide reliable, quality service in all scenarios.

In summary, network costs are driven by the combination of demand and generation profiles, as well as by the locations where demand and generation occur. As we discuss in a later section of this chapter, modifying net profiles is an effective way to integrate variable energy resources.

Figure 7.2 Extreme Net-Load Scenarios for a Customer with a PV Generator

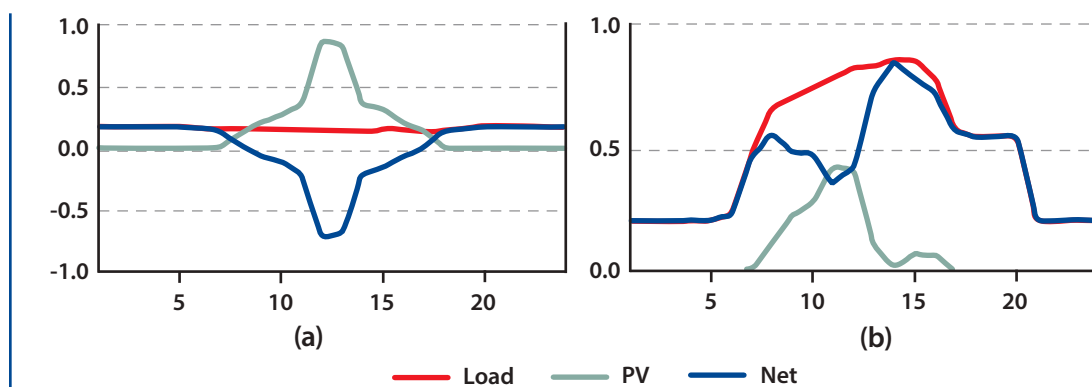

Note: The graphs shown are for a commercial customer in the city of Lancaster, California. All the values are expressed as a fraction of the annual maximum load. Hours of the day are on the horizontal axis.

Issues Related to Distributed Generation

As we have seen, distributed generators can impose a second extreme scenario, maximum generation, on a network that is prepared to meet only maximum load. In addition, the intermittency of solar generators can affect the operation of automatic devices. The most frequent problems related to a substantial presence of PV generators in distribution networks are described below:

- Transformers and lines are designed to maintain voltage at the consumption points within a specific range, considering that the load can be anywhere between zero and a maximum value. For feeders connecting customers that have enough PV capacity to become net generators, the voltage at certain hours can exceed the maximum allowed level. When that occurs, the distribution company has to apply measures to decrease line impedance (e.g., use a bigger conductor) or install voltage regulators to bring voltage back within an acceptable range. Since PV generators are dispersed and voltage control is a local problem, voltage issues can be significant even when the aggregate amount of PV capacity in the network is small.
- In the event of a fault, automatic protections can isolate part of the grid to avoid compromising a larger area while maintenance teams are sent to the site to clear the fault. When distributed generators are connected to faulty areas, their controllers may fail and attempt a re-connection to the faulty grid, endangering workers. This translates into a need for more complex safety measures than when no DG is present.
- The cost of fault protections is related to the maximum fault current that needs to be interrupted. The presence of DG — and the presence, in particular, of current sources like the inverters used in PV systems — increases the magnitude of the fault current, sometimes rendering existing protections inadequate.
- Distributed generators with electronic interfaces can increase the harmonicⁱⁱ content of the voltage and current and induce flicker.ⁱⁱⁱ These are important power quality indicators and when their values are out of range they can cause visual discomfort (in the case of flicker) or the disconnection of local load and generation (in the case of harmonics).
- Where automatic voltage control is used in the form of voltage regulators, switched capacitors, or transformers with on-load tap changers, the intermittency of solar generators can cause the devices involved to operate more frequently and shorten their useful life. This is because these devices commonly use mechanical switches that deteriorate with the number of switching operations.

To minimize system issues related to the introduction of distributed generators, the Institute of Electrical and Electronics Engineers (IEEE) created IEEE Standard 1547, which was intended to provide a set of criteria and requirements for the interconnection of DG resources into the power grid in the United States and elsewhere. The impact of DG on distribution networks has been widely studied by the electric power industry, academics, and regulators in many places in the world, with results for specific cases that are consistent with the general results and findings reported in this chapter.^{8,13}

ⁱⁱIn alternating current (ac) systems, voltage and current change in time following a sinusoidal pattern characterized by a fundamental frequency (60 Hertz in the United States). When non-linear components are connected to the network, the now distorted pattern also contains harmonic frequencies.

ⁱⁱⁱFlicker refers to fast variations of the voltage magnitude that can be detected by the human eye watching a lightbulb.

Photovoltaic Generation

Several indicators or parameters are commonly used to characterize PV generators in electric power systems:

1. **Nameplate alternating current (ac) output** describes the power output of a PV facility at the ac coupling point under standard test conditions. This value is usually between 70% and 85% of the nameplate direct current (dc) output.
2. **Capacity factor** is calculated by dividing average power production (over a year) by the nameplate ac output of the PV facility.
3. **Energy share** describes total yearly PV generation as a fraction of total yearly load for the entire network.
4. **Penetration** is the maximum ratio of PV generation to demand at any time. It is important to note that this ratio is defined relative to a certain load. For example, a 1-MW PV panel can mean 1% power penetration for a small town, or 20% penetration for the neighborhood where it is connected. Penetration also has implicit temporal dependency, as the same panel will have a different power penetration in a commercial area than it would in a residential one.^{iv}

Depending on the size and location of the connection point, the generator can be coupled to the grid at different voltage levels through an inverter. The selection of the connection voltage is related to the size of the plant: usually small rooftop arrays will be connected to LV sections of the network, more extensive arrays (owned by municipalities or commercial entities) will be connected to MV sections, and utility-scale plants (MW range) will be connected to high voltage (HV) sections.

^{iv}Usually commercial load is more correlated with solar radiation than residential load (Figure 7.1). Therefore, for equal load magnitude and size of PV systems, the power penetration as defined above will be higher in residential areas.

7.3 SCOPE AND METHODOLOGY

This chapter focuses on the effects of noticeable amounts of distributed PV generation on electricity distribution networks that were created using traditional engineering practices. Under the heading of *distribution cost*, we include all the investment costs and operating expenses of a company that owns and operates the network infrastructure. Losses of electricity as it travels through the distribution network are calculated separately because, depending on the specific regulatory framework and the allocation of functions and responsibilities to the distribution company, these losses may or may not be considered an actual distribution cost.

This section explains the methodology used to explore the relationship between current distribution-network characteristics and the magnitude and nature of additional costs associated with hosting significant quantities of PV generation in the future.

Distribution networks are at least as diverse as the places they serve, and different companies have developed their own engineering and design practices through studies and trial-and-error processes, conditioned by the local availability of products and services. Therefore, establishing a relationship between a change in the characteristics of network users, like the introduction of rooftop PV systems, and the impact of this change on distribution costs and losses is complex if general results are sought. For this reason, we chose not to study existing systems, opting instead to build — via simulation — several prototype networks with different characteristics, designed to cover a wide range of network types. For each prototype network, we studied several scenarios in which different amounts of PV generation have been added at an unspecified point in the future.

Both the prototype networks and the scenario analyses were developed with the aid of a Reference Network Model (RNM)¹⁶ developed by Spain's Instituto de Investigación Tecnológica (IIT).^v The model emulates the distribution company's engineering design process, specifying all the components between the transmission substation and the final customers that together comprise the minimum-cost distribution network, subject to power quality constraints. RNM can be used to perform *greenfield* and *brownfield* planning. In *greenfield* mode, which is used here to create prototype networks, it produces a detailed design of the least-cost network in a scenario that lacks any constraints imposed by prior infrastructure investments. For the study of

future network utilization scenarios, the *brownfield* RNM is used to calculate additional network costs and losses.

Generation of Host Networks

The host networks in our analysis are based on regions with high and low population densities in six diverse parts of the United States (Figure 7.3).

For each of the six states listed in Table 7.1 we chose two specific locations — one with low population density and the other with higher density — as templates. Figure 7.4 illustrates the procedure used to create prototype host networks:

Figure 7.3 Average Daily Insolation Map of the United States and Selected Locations for Network Simulation

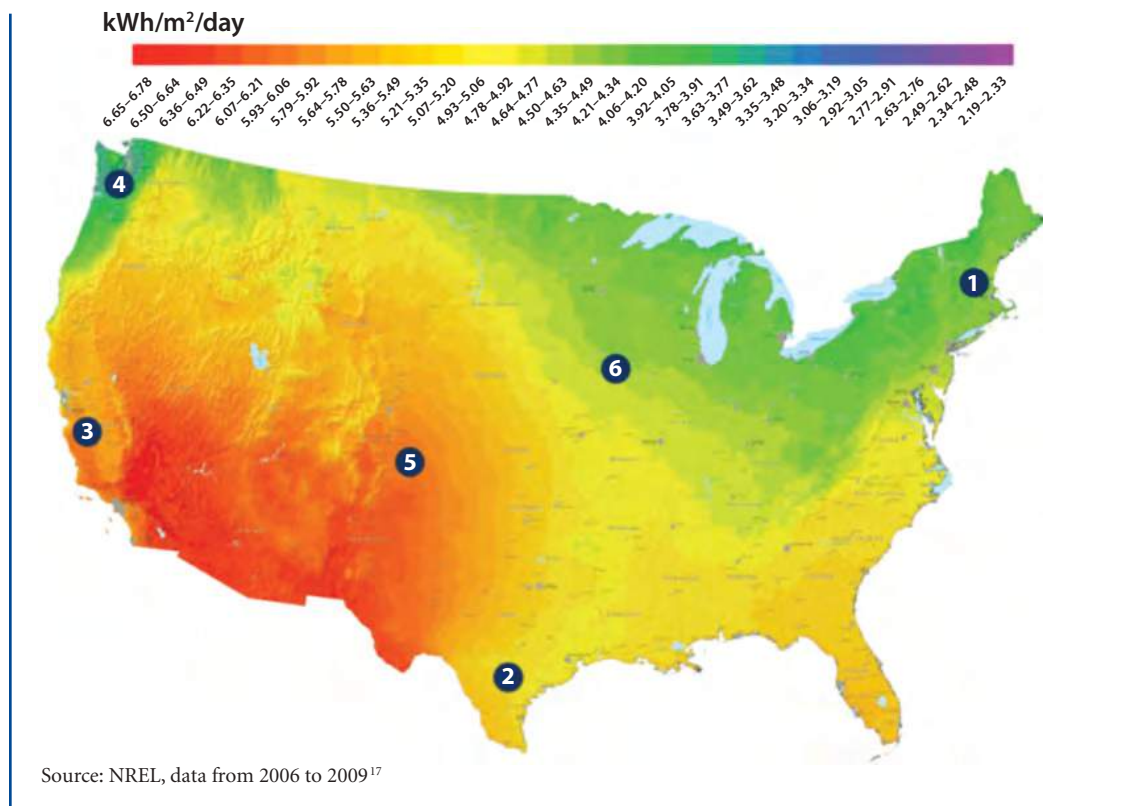

^vIIT is part of Universidad Pontificia Comillas, Madrid. IIT's RNM model has been used to calculate the allowed remuneration of distribution companies in Spain and its results have been validated both by these companies and by their regulators. RNM has also been used in several other countries and in numerous studies.

1. Street maps of each location are used as a scaffold (Figure 7.4a) and the layout of streets is used as a proxy for the density of connection points. The location of potential connection points is constrained to the streets recognized in Figure 7.4b, with equal probability per unit of street length. For example, if an area has 20,000 potential connection points (loads, generators, or both) and 200 kilometers of street, there will be on average 100 connection points per kilometer of street. The exact location of each connection is a random draw from a uniform probability distribution.
2. The number of customers, along with their individual load size and type, is determined based on aggregated assumptions for load density, distribution of demand profiles, and average customer size. The points generated in this way are geographically assigned to viable connection points as defined in the prior step of the analysis (Figure 7.4c). The host networks contain no distributed generation.

Table 7.1 Reference Locations for Prototype Networks¹⁷

Number	State	Low Density	High Density
1	Connecticut	Torrington	Hartford
2	Texas	San Marcos	Austin
3	California	Lancaster	Los Angeles
4	Washington	Covington	Seattle
5	Colorado	Eaton	Boulder
6	Iowa	Altoona	Des Moines

Figure 7.4 Procedure for Designing a Base Network

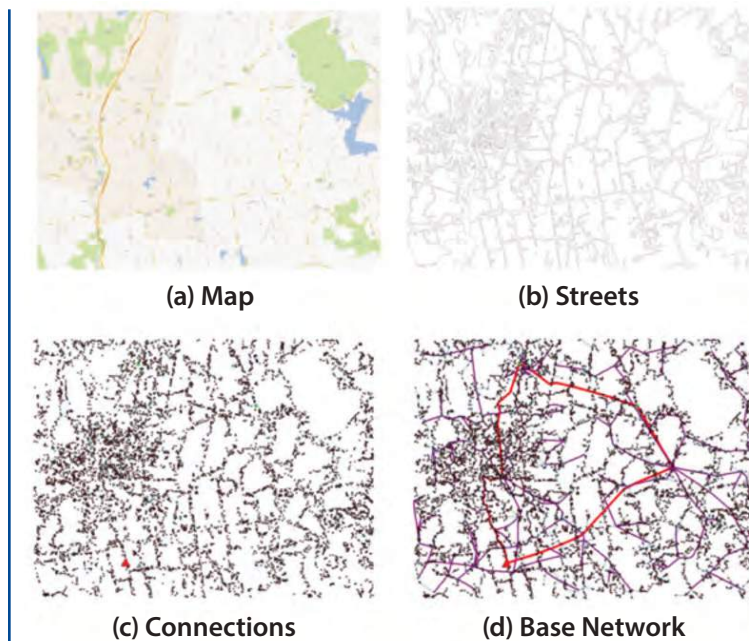

Note: The initial map of the region under study is shown in (a), while (b) and (c) illustrate the assignment of network users to geographic locations and (c) shows the network designed by RNM with three voltage levels — LV in green, MV in magenta, and HV in red.

3. The design of the distribution network is done with the greenfield RNM using a standard catalog of network equipment (Figure 7.4d).^{vi} Since the greenfield RNM doesn't take hourly profiles explicitly into account, they are represented by simultaneity factors with respect to the peak load.

Formulation and Simulation of Energy Share Scenarios

The 12 host networks were analyzed subject to the conditions shown in Table 7.2 and for several scenarios with different PV energy shares. The estimation of costs for each scenario starts with an assumption about the amount of PV capacity to be installed, which then translates into annual energy production taking into account the yearly insolation of the different locations. The total capacity assumed for each scenario is such that yearly PV electricity output ranges between 0% and 40% of yearly load. For each network, the analysis considers eight PV energy share scenarios.

To allocate the total amount of PV generation assumed in each scenario among a set of individual generators, we made assumptions about the average size and spread of generators for each voltage level that reflect realistic practices. To assign geographic locations to individual PV generators, we assumed that — in LV and MV areas — these generators are going to be associated with consumers that

exist in the host network. Since both consumers and generators come in different sizes, we match them by choosing, for each PV generator, the consumer that has the closest-size load to the generator's electricity output at the time of maximum solar energy production. For PV generators that are connected to HV lines, their locations are constrained to a number of pre-defined places on the map, which were identified by inspecting satellite images of the area in question. Since, for purposes of this analysis, PV generation is expected to occur in the future, a 2% increase in electricity demand (or load) is assumed for all scenarios. Other values for expected demand growth, ranging from 0% to 30%, were tested but we determined that this assumption does not qualitatively affect the results.

The analysis adopts a *brownfield* perspective (meaning that it takes the existing network, as opposed to no network, as its starting point) to determine infrastructure needs and to estimate the costs of energy losses, which are due mainly to resistive heating.

Since the impact of PV generators on the distribution network is related to their power generation profile, their location in the network, and the load and generation profiles of other network users, at least two extreme scenarios need to be considered to design the network (Figure 7.2). After the new generators and load points have been established, each is

Table 7.2 Network Parameters Considered in the Simulation Analysis

Load	L1	80% residential, 15% commercial and 5% industrial
	L2	15% residential, 80% commercial and 5% industrial
Network Design	E1	European
	E2	United States
Storage	S1	No storage
	S2	Storage factor = 0.2
	S3	Storage factor = 1

^{vi}Two catalogs of equipment and voltage levels are used for the U.S. and EU simulations, reflecting the differences described in Section 7.2.

assigned a power profile. Three types of load are considered — residential, commercial, and industrial^{vii} — with a typical power factor for all of them.^{viii} Finally, the brownfield RNM is used to model required network adaptations and losses induced by the addition of PV generation in each scenario.

7.4 RESULTS

Figure 7.5 shows results from four scenarios denoted as L1E1S1, L2E1S1, L1E2S1, and L2E2S1 to reflect the combinations of

parameters (from Table 7.2) assumed in each case. The figure reveals that significant penetration of PV generation can be a relevant cost driver in distribution networks, assuming that our sample adequately represents the diversity of networks that can be found in the power industry. Note that the x-axis in most of the figures corresponds to the ratio of annual PV generation to total load, and that a color scale has been used to identify the capacity factor of PV installations at the location considered in each particular simulation.

Figure 7.5 Total Network Cost after the Introduction of PV Generators

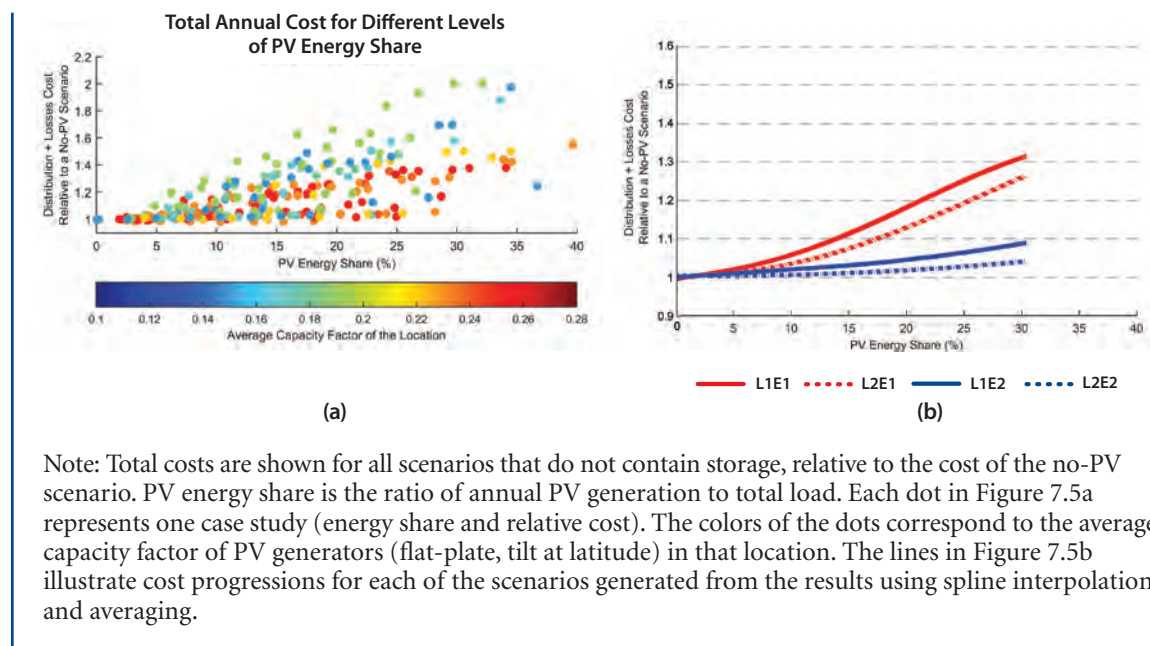

Note: Total costs are shown for all scenarios that do not contain storage, relative to the cost of the no-PV scenario. PV energy share is the ratio of annual PV generation to total load. Each dot in Figure 7.5a represents one case study (energy share and relative cost). The colors of the dots correspond to the average capacity factor of PV generators (flat-plate, tilt at latitude) in that location. The lines in Figure 7.5b illustrate cost progressions for each of the scenarios generated from the results using spline interpolation and averaging.

^{vii}Load profiles for commercial and residential customers were obtained from simulated hourly load profile data for 16 commercial building types (based on the U.S. Department of Energy’s commercial reference building models) and residential buildings (based on the Building America House Simulation Protocols) for all locations in the United States with TMY3 (typical meteorological year) weather profiles. These load profiles are publicly available on the website <http://en.openei.org>. Since load profiles for industrial customers are more heterogeneous and depend on the particular process characteristics of the industrial facility in question, a set of profiles with small variability was generated by hand. PV generation profiles (and derived capacity factors) were generated using the application PVWatts Version 1, which is available at <http://www.nrel.gov/rredc/pvwatts/> (note that this software also uses TMY3 weather files).

^{viii}Generators and loads connected to ac networks exchange active and reactive power. Reactive power is not related to a useful energy flow from source to sink, but impacts losses and voltage profiles. The power factor (PF) is a number used to quantify the amount of reactive power that a device uses or generates. A PF of 1 means that the device only exchanges active power — thus, the fraction of reactive power increases as the PF decreases. When reactive power is consumed, the device is called *inductive*; in the opposite case, the device is called *capacitive*. In all cases in the analysis, the power factor considered for loads was 0.8 inductive.

These results are consistent with the fact that, as PV energy share increases, more neighborhoods become net generators at certain hours, so that feeders need to be ready to cope with power flows in the maximum generation scenario as well as in the maximum load scenario. Other costs related to the connection of distributed generators — such as the need for bi-directional protections, active filters, and enhanced safety measures for workers — were not taken into account.

Impact on Energy Losses

Figure 7.6 shows distribution network energy losses and associated costs as PV energy share increases. The graphs reveal that costs from such losses have a general tendency to decline as the share of PV energy in a distribution network increases up to nearly 25%. There are two reasons for this result:

1. Part of the original load has been offset by local generation. As long as the net amount of power being delivered to customers is, in magnitude, less than the original load, distribution system losses are smaller.

Significant penetration of PV generation can be a relevant cost driver in distribution networks.

2. In places where net generation is significant (i.e., DG output substantially exceeds customer demand), over-voltage issues during specific hours require wire reinforcements that contribute to decreasing losses in all hours.

FINDING

When all impacts of adding distributed PV generation are considered, distribution losses decrease as the PV energy share increases. At very high levels of PV penetration, losses start to increase.

When the PV energy share goes beyond a certain value, however, the results shown in Figure 7.6 reveal that losses from higher current in the wires dominate and associated costs start to increase.

Figure 7.6 Annual Network Losses after the Introduction of PV Generators

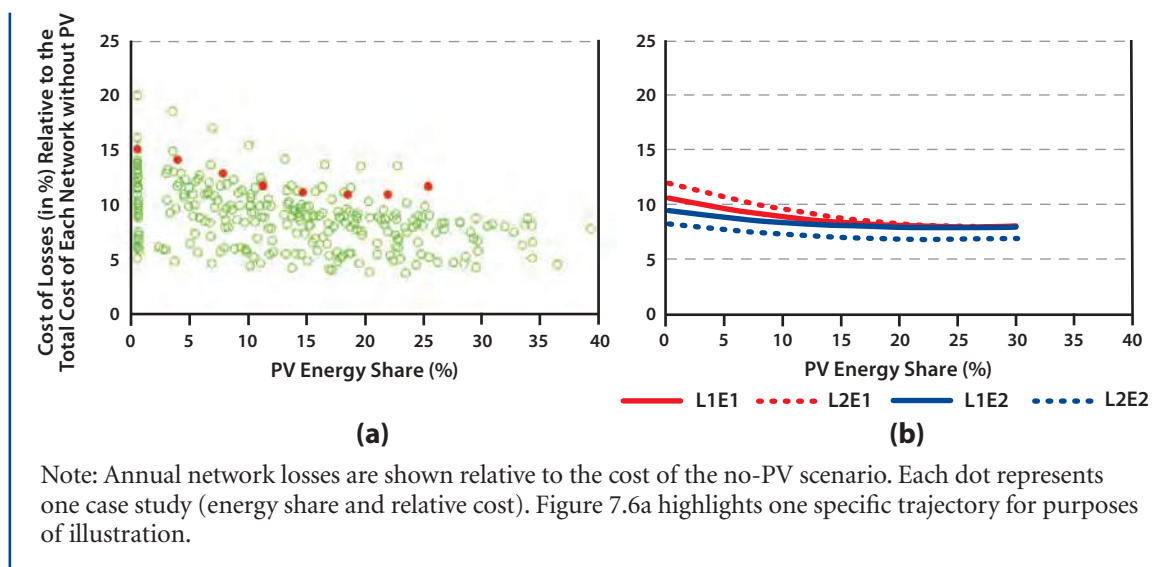

FINDING

The dominant impact of a significant PV energy share on a distribution network is to require new investments to maintain quality of service. Total distribution costs (which include distribution investment and operation costs, plus losses) increase with PV energy share.^{ix}

FINDING

Numerical cost results for the U.S. and European networks differ significantly, for reasons that can be attributed to differences in network layouts. Given its practical implications, this issue deserves further investigation,^x although the qualitative conclusions of the analysis hold in both settings.

Cost Drivers

A more detailed inspection of these results, and of Figure 7.5 in particular, reveals additional facts that are helpful in understanding the impact of PV generation on distribution networks:

1. The extra network cost imposed as a function of PV energy share is going to be lower in places with higher capacity factors. This is because the network has to be able to cope with the maximum generation profile (e.g., clear-sky day in summer) when PV output is going to reach capacity. Since a place with lower insolation will require higher installed PV *capacity* to achieve the same *energy* output, the stress over the network at times of peak radiation is going to be larger. This fact is illustrated in Figure 7.7 for two networks in rural locations with similarly large PV energy shares. Figure 7.7a shows

Figure 7.7 Daily Load and PV Generation Profiles for Two Networks with High PV Penetration

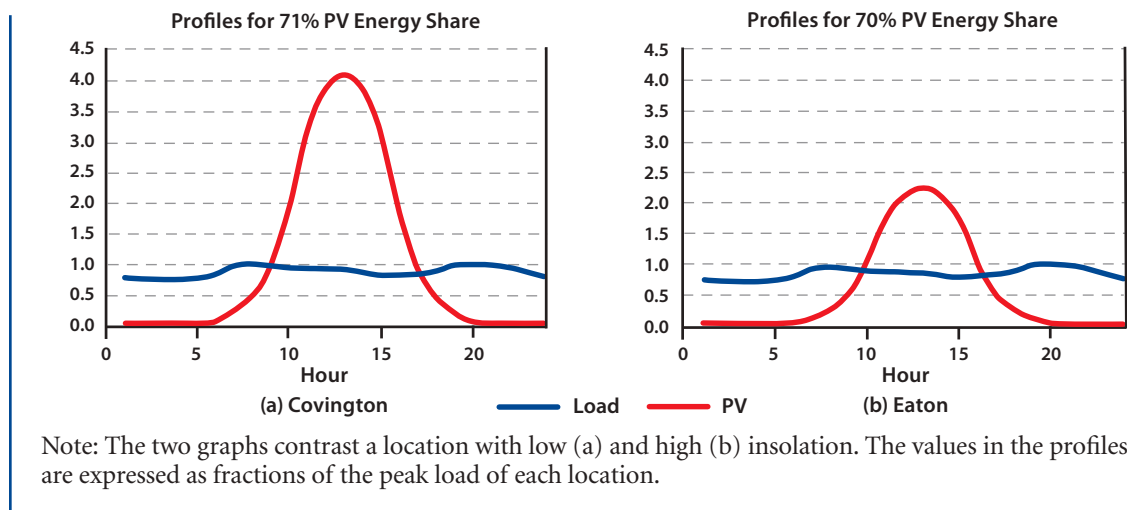

^{ix}To compare across networks, the results presented correspond to the sum of the annuity of investment plus annual recurring costs.

^xMost of the difference in cost for the European layout is explained by significant reinforcements in the LV network in response to voltage issues. While RNM considers increasing the wire gauge and installing voltage regulators and capacitors to correct these problems, an actual distribution company facing serious PV integration challenges may use other techniques. For example, experiments with a modified RNM showed that allowing for changes in the topology of the network can reduce the magnitude of the cost impact by about 10%. Demand response, deployment of storage, or control of the PV inverters are other possibilities.

that Covington’s network needs to be prepared for a worst-case scenario where PV generation reaches more than four times the maximum load, while for the Eaton network, this worst-case ratio is only about 2.5.

2. The low impact of PV generators for low values of PV energy share in Figure 7.5 can be understood by examining Figure 7.8. Note that, for small PV energy shares, only a very small number of power flows have changed direction (most generation goes

to offset local load) compared to the flows in the reference case with no PV. Also, the reduction in wire losses is enough to offset any additional distribution costs. This is no longer true at significant PV energy shares — in these scenarios, since distribution network problems are strongly local and mainly related to voltage issues, the implication of Figure 7.8d is that many sectors would violate power quality constraints if no upgrades are applied to cope with changes in power flows as a result of the PV presence.

Figure 7.8 The Effect of Different Levels of PV Penetration

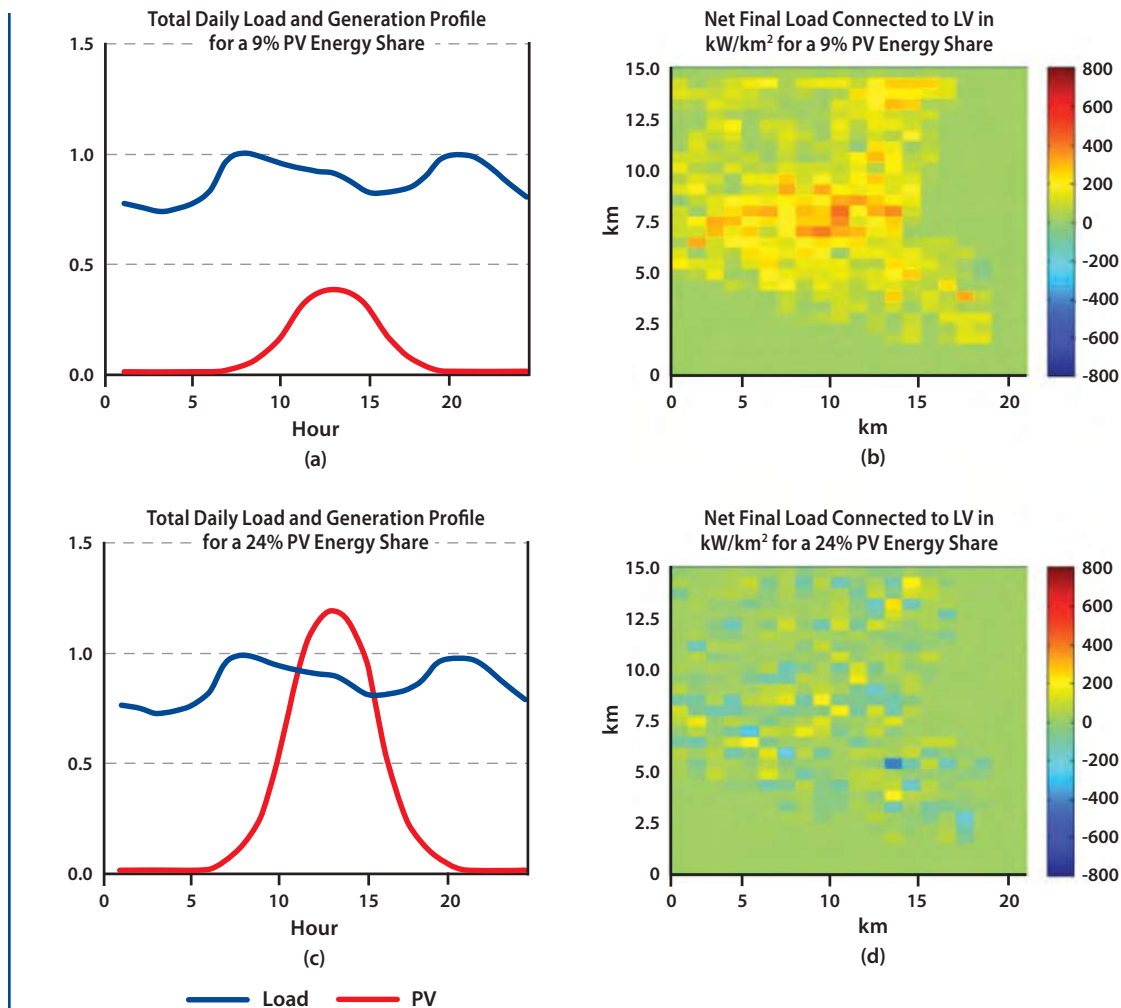

Note: Effects are shown in terms of aggregated load profiles and spatial power density at the time of maximum PV generation for the Torrington network. The region is divided into 600 sectors and the color of each sector, according to the colorbar on the right, corresponds to the sum of all power injections and consumptions that occur at the solar noon. All values shown for the load and generation profiles in (a) and (c) are expressed as fractions of peak load.

FINDING

For the same level of PV energy share, locations with higher solar insolation require less additional network investment to maintain quality of service, since their maximum PV generation is lower.

Another interesting indicator can be derived by dividing the total incremental net present cost (NPC) of necessary distribution network investments by the total installed PV capacity in every scenario.^{xi} The results shown in Figure 7.9 suggest that each individual kW_p of installed

PV capacity can, in some cases, lead to tens of dollars of additional annual network costs. The variation in cost impact that can be seen in the scatter plot in Figure 7.9a is explained by the lumped nature of network investments and different network characteristics. The trend lines in Figure 7.9b reveal that the marginal extra cost is not constant, but interestingly non-linear. Adding 1 kW_p to a network with no installed PV capacity does not affect costs significantly. For large penetrations, the marginal cost impact of each added kW flattens or gets smaller.

Figure 7.9 Total Incremental Annual Network Costs Divided by the Amount of Installed PV Capacity, as a Function of the PV Energy Share

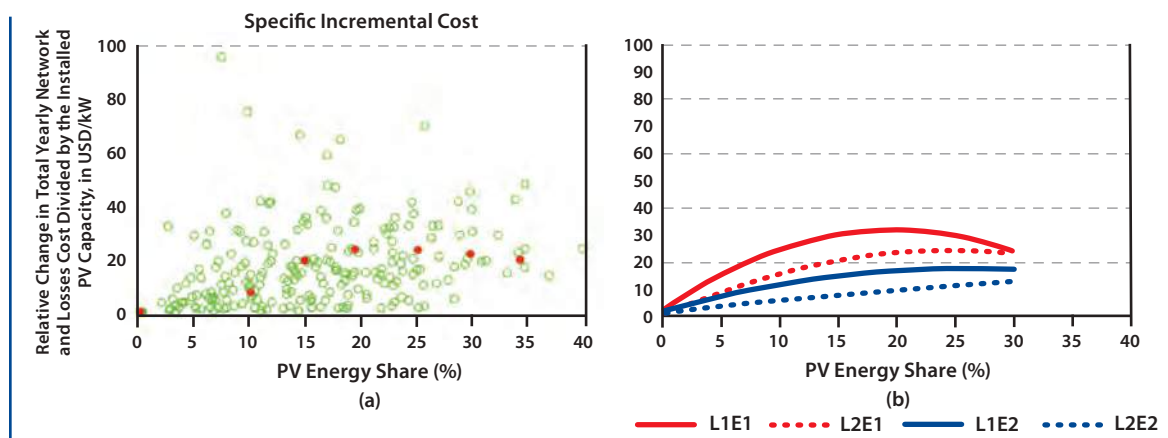

Note: Figure 7.9a includes all observations for 12 networks, 4 load and catalog assumptions, and between 6 and 8 PV energy share scenarios. The observations highlighted in red correspond to a particular impact trajectory across 7 PV energy share scenarios for a particular network and set of assumptions. In Figure 7.9b, we use second-order polynomials to interpolate every impact trajectory for each set of assumptions, and average the resulting polynomials evaluated over an evenly spaced horizontal axis to identify trends.

^{xi}A discount rate of 10% was used to calculate the net present cost.

Disaggregated Results

Geographic differences between networks affect both the total cost of accommodating distributed PV and the relative importance of different cost components. Looking at the cost structure of the networks included in this analysis, we find that rural networks (Figure 7.10a) tend to require significant upgrades in the HV network, while urban networks (Figure 7.10b) usually require larger investments in LV equipment. This reflects the greater availability of sites suitable for installing large-scale arrays in rural areas, which in turn usually requires building new HV lines. In contrast, urban areas in many different locations have plenty of rooftop space that is normally already connected to the LV network. Note that, in most cases, connecting DG to any given voltage level on the system will also impact the other voltage levels.

The Value of Energy Storage

The need for network upgrades is mainly driven by the amount of installed PV capacity, which may cause significant reverse power flows at certain hours. Since “smoothing” the flow profile would alleviate this impact and therefore eliminate or reduce needed upgrades, energy storage can be seen as an alternative to investing in conventional network equipment to accommodate high PV-penetration scenarios.

Energy storage can be seen as an alternative to investing in conventional network equipment to accommodate high PV-penetration scenarios.

To quantify the potential cost savings associated with distributed storage, assumptions about the size of each storage device, about their location in the network and about the way they are

Figure 7.10 Disaggregated Network Costs

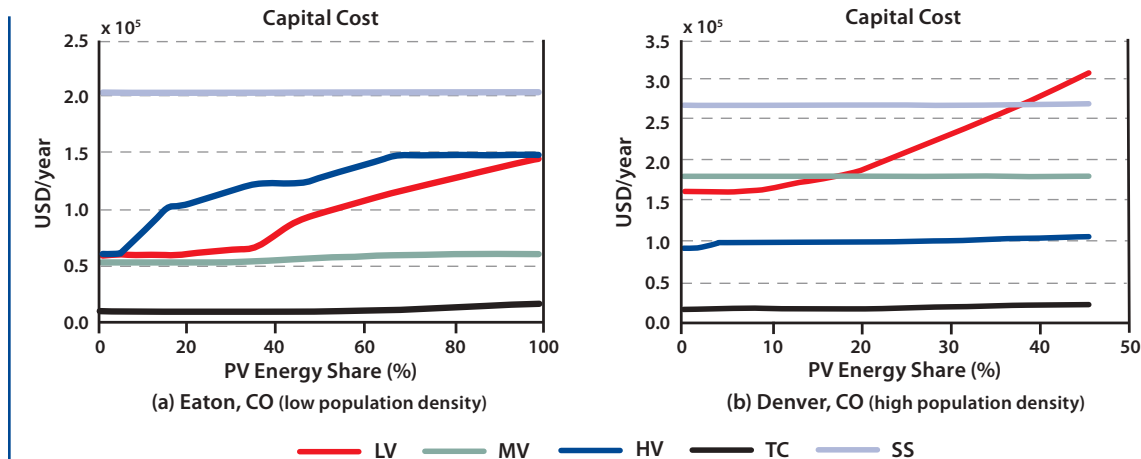

Note: LV, MV, and HV correspond to wires in low voltage, medium voltage and high voltage networks respectively; substations (SS) correspond to high/medium voltage transformers and transformation centers (TC) correspond to medium/low voltage transformers. Note that LV increments are smoother than HV increments, reflecting the more lumped nature of HV investments (the term “lumpy” is often used to describe investments that are small in number, but large in magnitude and that do not occur continuously). All cost figures shown are total (not incremental) and in dollars per year. In Figure 7.10a, the PV energy share can exceed 100% because this scenario allows for exports of PV-generated electricity to other networks.

operated are necessary. In the following analysis it is assumed that the batteries share the connection points of all the medium voltage and high voltage customers who own a PV generator, and that they are operated to limit the power injected to the network while maintaining the same state of charge at the end of every day. The injection limit is specified as a fraction of the rated load through the so-called *storage factor* (SF) parameter, which can have a value between zero and one. As illustrated in Figure 7.11, when SF=0 the battery absorbs any power injection in excess of the rated load; when SF=1, the battery absorbs any power injection; for SF=0.2, it absorbs any power injection in excess of 0.8 times the rated load.^{xii} The energy stored, discounted by an efficiency factor of 0.8, is discharged at a constant rate in the hours when power is being consumed from the network — thereby preventing the batteries from getting full. By simulating an entire year of operation using this rule, the size of each battery has been calculated as 1.2 times the maximum daily variation in the state of charge. The results shown in Figure 7.12 compare previously calculated additional network costs (black dots and lines) with costs for different storage factors.

For each host network and penetration level, we subtract the cost results of both runs (with storage and without storage) and divide those savings by the total amount of storage installed to obtain a measure of the annual value of distributed energy storage.^{xiii} For the networks studied here, savings range from zero to \$35 for each kWh of storage introduced, which suggests that storage systems with costs in the range of \$140 per kWh and a lifetime of more than four years could be a viable alternative to network infrastructure reinforcements as a way to cope with high PV penetration. Note that PV systems with lower capacity factors,

such as systems in locations with lower levels of insolation, will produce fewer episodes of reverse flows for the same level of power penetration — therefore, batteries in those locations will tend to have a longer useful life. For example, a Trojan® T-105 battery costs \$120, has a useful capacity of 1 kWh and can provide 500 cycles. We estimate that such a battery participating in generation curtailment for a commercial load of a magnitude similar to the installed PV array in a location with 0.2 capacity factor would be used to store an amount of energy equivalent to less than 70 cycles per year — in this scenario the battery would be expected to have a lifetime of 7 years. However, dividing the cost of the battery by its lifetime throughput results in a storage-use cost of \$0.28/kWh, which means that unless the retail price of electricity exceeds \$0.28/kWh, curtailing PV generation is a more efficient option. Needless to say, economic signals that encourage load shifting to hours when PV generation is high should be the first resource to look at. Another issue to consider is that energy storage can provide other services that are compatible with generation peak shaving, like voltage support with reactive power and load peak shaving, in addition to other ancillary services like spinning reserve or frequency regulation. These ancillary services create a bundle of value streams that improve the competitiveness of storage options.

FINDING

Distributed energy storage may already be a viable alternative to network reinforcements or upgrades in some places. However, demand response and generation curtailment are likely to be more efficient integration alternatives, at least for the time being.

^{xii}In the context of this study, the rated power of the load corresponds to the maximum consumption value in a year.

^{xiii}A detailed explanation of this methodology is presented in a thesis by Vergara.¹⁸

Figure 7.11 Modification of Net Load for Different Energy Storage Factors (SF)

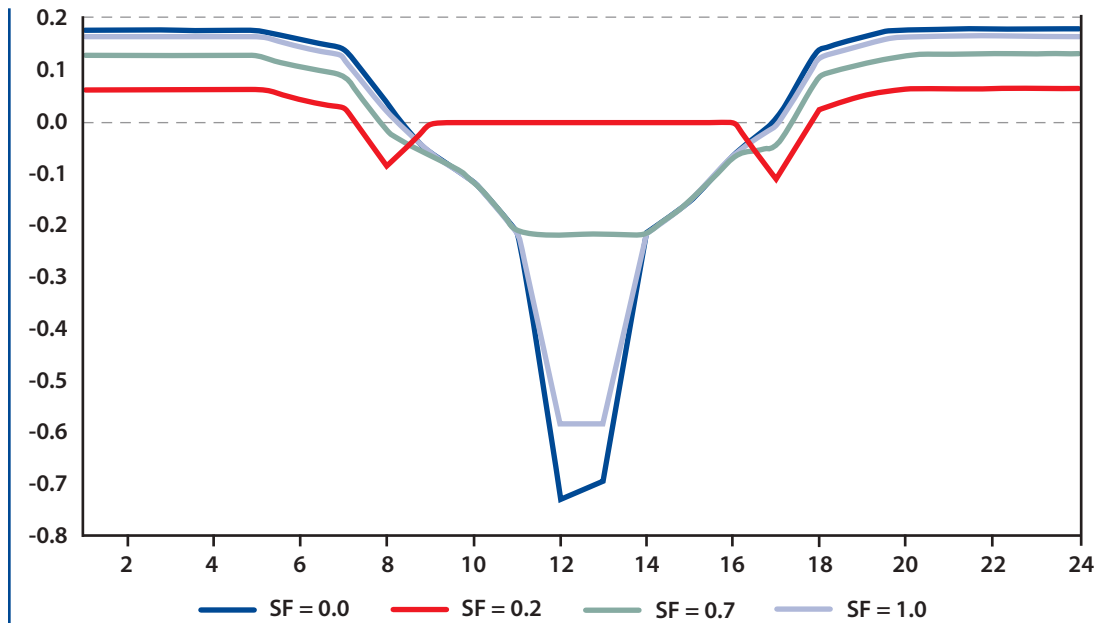

Note: All values are expressed as a fraction of annual maximum load. Hours of the day are shown on the horizontal axis.

Figure 7.12 Contribution of Energy Storage to the Integration of Distributed PV Generation

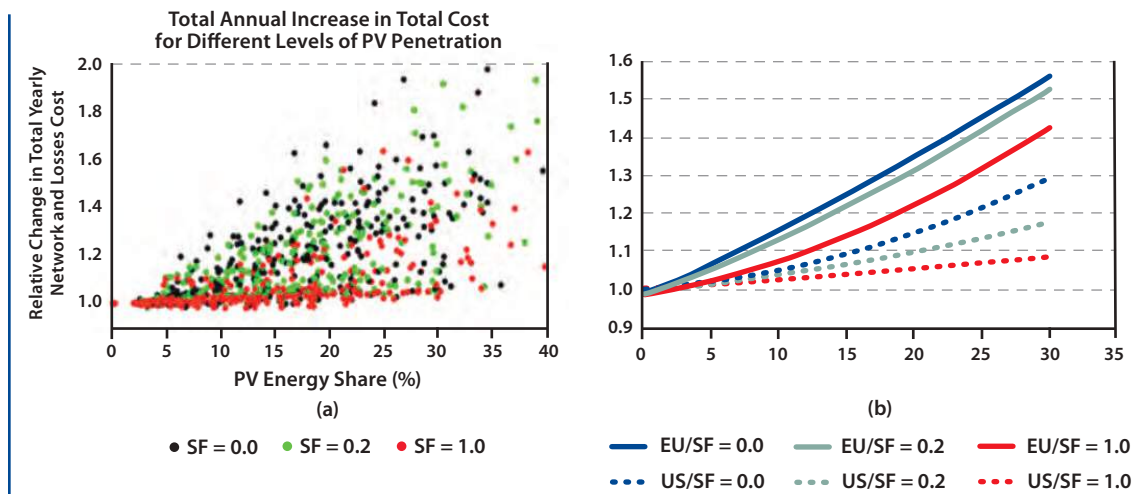

Note: The average cost-trajectories in Figure 7.12b were generated from the results using second-order polynomial interpolation and averaging.

The Shortcomings of a Dominant Distribution-Cost Allocation Methodology

Determining how distribution costs should be allocated among customers is a complex issue that will not be discussed here. Rather, this discussion focuses on a problem that can arise — and that is already affecting some networks now — when regulators follow a common approach to cost allocation. This common approach has two chief elements:

- A volumetric allocation of network cost is used, in which total network cost is distributed in proportion to the kilowatt-hours of electricity consumed by each customer. The average volumetric rate (i.e., \$/kWh) for the distribution component of customers' residential retail electricity bills is determined by dividing the total distribution network costs to be recovered from all residential users within each billing period by the total kilowatt-hours of electricity consumed by residential users at the end of the billing period. This per-kWh distribution network charge is bundled together with the charge for energy consumption and other regulated charges (such as charges for energy efficiency and renewable energy programs, industry restructuring, etc.) that are included in the electricity bill. For some residential customers, a fraction — typically a small fraction — of the bill also includes a fixed component or, if capacity is contracted, a charge per kW for the consumption capacity contracted over the billing period.

- Net-metering is employed to determine the volume of electricity consumed by a customer. That is, a single meter is used that increases or decreases measured consumption in proportion to the net flow of power from the network to the customer. When power flows from the customer to the network, measured consumption falls. After a predefined period of time (one or two months, typically, when conventional meters are checked), the value in the meter is read, and the customer pays the corresponding \$/kWh tariff multiplied by the net volume of electricity consumed.

Here we show by example what can happen in a particular network when both of the above elements are applied for purposes of cost allocation, as they often are. The first effect of this combination is shown in Figure 7.13a. As the penetration of DG goes up, customers who have installed PV systems (thereby becoming prosumers) will consume a lower volume of electricity from the grid. Since network costs do not decrease with greater PV penetration — on the contrary, they may even increase, as we have seen — the tariff that has to be applied to each kWh consumed to recover network costs has to increase. The prosumers with PV systems, who are responsible for both the reduction in overall kWh sales and for the increase in network costs, avoid a big portion of the cost, as Figure 7.13b shows. On the other end, customers without distributed generation systems fully absorb the impact of higher tariffs — an outcome that is likely to be perceived as unfair.^{xiv} Moreover, these customers will have an incentive to get their own PV system, resulting in a positive feedback mechanism that — taken to an extreme — could render the distribution business non-viable.

^{xiv}The results shown here assume a standard meter that is read once a year. When a shorter reading period is used, the asymmetry will be reduced because there will be periods in which PV production is lower than in other periods. For example, if monthly metering is available, the avoided network charge in winter months will be smaller.

Figure 7.13 Effect of Volumetric Tariff under Net-Metering for the Des Moines Host Network

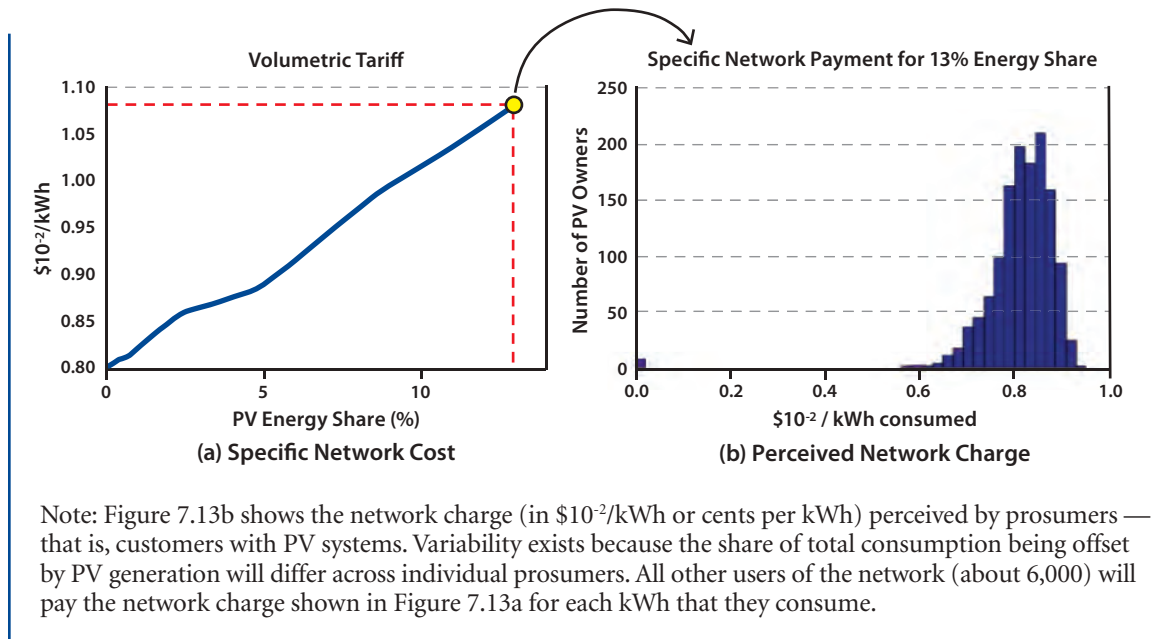

As the ways in which individuals utilize the distribution network diversify, so too do the impacts of their use on distribution system operations and investments. A method is needed for allocating distribution system costs in a differentiated manner that more directly relates individuals' network use behavior to their contribution to network cost. This can be achieved by applying the principle of cost causality: network users are charged according to how their network utilization causes or contributes to distribution costs.

Identifying the key drivers of network costs is fundamental to the design of cost-reflective “distribution network use of system” or “DNUoS” charges. The total distribution system cost is comprised of the total cost associated with each cost driver. These cost drivers include network users' mere need to be connected to the distribution network, users' contributions to distribution system electricity

A method is needed for allocating distribution system costs in a differentiated manner that more directly relates individuals' network use behavior to their contribution to network cost.

losses, users' contributions to peak power flows, and users' reliability requirements. The share of the total distribution system cost attributable to each cost driver can be determined with the use of a model like RNM, which has been already described. The cost attributable to each driver can then be allocated among network users on the basis of users' contributions to the cost drivers. An individual user's contribution to each of the cost drivers is captured in the user's *network utilization profile*, which includes all of the information contained in the hourly profile of energy injections and withdrawals at the user's point of connection to the distribution network. By employing network utilization profiles for cost allocation, network users are

charged according to their contribution to the factors that drive total system cost. Pérez-Arriaga and Bharatkumar (2014)²¹ describe a more detailed proposal for the design of distribution network charges.

Designing DNUoS charges according to the principle of cost causality aligns with the objective of increasing economic efficiency, but presents a host of implementation challenges. The use of network utilization profiles to compute DNUoS charges leads to individualized and potentially highly differentiated charges for each distribution network user, and thus substantially departs from the common practice of network cost socialization. Regulators might therefore choose to adjust the theoretically most-efficient allocation of network costs to account for a range of other considerations and to achieve other regulatory objectives such as greater socialization of network costs and equity.

FINDING

When single bi-directional standard meters are used, volumetric network charges result in customers with PV generators partially avoiding network charges, leaving other network users and/or distribution company shareholders to assume higher costs.

7.5 CONCLUSION

The analysis described in this chapter shows that, under current practices and existing network designs, distributed PV generation can have a significant impact on the costs associated with delivering electricity. Absent specific mitigating measures, areas with low insolation may come close to doubling their distribution costs when the annual DG contribution exceeds one-third of annual load.

Although it seems reasonable to expect that generating electricity close to loads brings energy losses down and requires less network infrastructure to carry energy from other regions, these benefits are not realized in situations where distributed generators are not controllable; where mismatches exist between load and generation, both in terms of location and time; and where networks continue to be managed in the usual way. In these situations, active network management and coordination can play a relevant role, reducing dual-peak demands over the system and minimizing losses through the exploitation of flexible demand and distributed storage, as well as through actions taken within the network itself, such as reconfiguring the network, controlling PV inverters, or regulating transformer voltage. Before active management solutions can emerge, however, adequate regulations must be implemented. For example, we have shown that common rate-setting practices such as net-metering and volumetric cost allocation do not contribute to better system management and can induce inefficient hidden subsidies. By contrast, alternative approaches should aim to incentivize efficient responses by network users using a system of charges and credits that is consistent with sound principles of cost causality.¹⁹

Alternative approaches should aim to incentivize efficient responses by network users using a system of charges and credits that is consistent with sound principles of cost causality.

REFERENCES

- ¹Baker, E., M. Fowle, D. Lemoine, and S.S. Reynolds. "The Economics of Solar Electricity." *Annual Review of Resource Economics* 5: Submitted. Doi: 10.1146/annurev-resource-091912-151843. <https://ei.haas.berkeley.edu/research/papers/WP240.pdf>
- ²Vanderberg, M. et al. *Prioritisation of Technical Solutions Available for the Integration of PV into the Distribution Grid*. Technical Report, PV-GRID. (2013). http://www.pvgrid.eu/fileadmin/130626_PVGRID_D3_1_Final.pdf
- ³Kassakian, J. G., and R. Schmalensee. *The Future of the Electric Grid: An Interdisciplinary MIT Study*. Technical report, Massachusetts Institute of Technology. (2011). http://mitei.mit.edu/system/files/Electric_Grid_Full_Report.pdf
- ⁴Begović, M., A. Pregelj, D., A. Rohatgi, and D. Novosel. "Impact of Renewable Distributed Generation on Power Systems." *34th Hawaii International Conference on System Sciences*, pp. 654-663. IEEE Computer Society. (2001). <http://ieeexplore.ieee.org/xpl/articleDetails.jsp?arnumber=926265>
- ⁵Mitra, P., G.T. Heydt, and V. Vittal. "The Impact of Distributed Photovoltaic Generation on Residential Distribution Systems." *North American Power Symposium (NAPS)*, 2012, pages 1–6, IEEE. (2012). <http://ieeexplore.ieee.org/xpl/articleDetails.jsp?arnumber=6336330>
- ⁶Shayani, R. A., and M. Aurélio Gonçalves de Oliveira. "Photovoltaic Generation Penetration Limits in Radial Distribution Systems." *Power Systems, IEEE Transactions on* 26, no. 3. (2011): 1625-1631. <http://ieeexplore.ieee.org/xpl/articleDetails.jsp?arnumber=5594978>
- ⁷Chen, Po-Chen, et al. "Analysis of Voltage Profile Problems Due to the Penetration of Distributed Generation in Low-Voltage Secondary Distribution Networks." *Power Delivery, IEEE Transactions on* 27, no. 4. (2012): 2020-2028. <http://ieeexplore.ieee.org/xpl/articleDetails.jsp?arnumber=6298062>
- ⁸*The Impact of Localized Energy Resources on Southern California Edison's Transmission and Distribution System*. Southern California Edison. (May 2012). http://www.energy.ca.gov/2013_energypolicy/documents/2013-08-22_workshop/SCE_Local_Energy_Resources_Study.pdf
- ⁹Brantl, J. "New Challenges for DSO." *Task 14 High Penetration PV Workshop*, SMA, Kassel, Germany. IEA Photovoltaic Power Systems Programme. (2012).
- ¹⁰Bebic, J. *Power System Planning: Emerging Practices Suitable for Evaluating the Impact of High-Penetration Photovoltaics*. National Renewable Energy Laboratory. (2008). <http://gisceu.net/PDF/U904.pdf>
- ¹¹Lindl, T., K. Fox, A. Ellis, and R. Broderick. *Integrated Distribution Planning Concept Paper: A Proactive Approach or Accommodating High Penetrations of distributed Generation Resources*. Interstate Renewable Energy Council. (May 2013). <http://www.irecusa.org/wp-content/uploads/2013/05/Integrated-Distribution-Planning-May-2013.pdf>
- ¹²Smith, J. *Alternative Screening Methods: PV Hosting Capacity in Distribution Systems*. Electric Power Research Institute. (2013). http://www1.eere.energy.gov/solar/pdfs/highpenforum2013_2_1_epri.pdf
- ¹³Pérez-Arriaga, I., et al. *From Distribution Networks to Smart Distribution Systems: Rethinking the Regulation of European Electricity DSOs*. European University Institute. (Jun 2013). <http://www.eui.eu/Projects/THINK/Documents/Thinktopic/Topic12digital.pdf>
- ¹⁴*Rate Design Matters: The Impact of Tariff Structure on Solar Project Economics in the U.S.*, GTM Research. (May 2013). <http://www.greentechmedia.com/articles/read/Rate-Design-Matters-Utility-Tariffs-and-Solar-Project-Economics>
- ¹⁵*Network Tariff Structure for a Smart Energy System*. Eurelectric. (May 2013). http://www.eurelectric.org/media/80239/20130409_network-tariffs-paper_final_to_publish-2013-030-0409-01-e.pdf
- ¹⁶Domingo, C. M., et al. "A Reference Network Model for Large-Scale Distribution Planning with Automatic Street Map Generation." *Power Systems, IEEE Transactions on* 26, no. 1. (2011): 190-197. <http://ieeexplore.ieee.org/xpl/articleDetails.jsp?arnumber=5504171>
- ¹⁷Roberts, B. U.S. *Photovoltaic Solar Resource: Flat Plate Tilted at Latitude (Poster)*. National Renewable Energy Laboratory. (Jan 23, 2008). <http://en.openei.org/wiki/File:NREL-National-PV-Poster.pdf>
- ¹⁸Vergara, C., "Representing Battery Energy Storage in Electric Power Systems Studies". PhD Thesis. University of Porto. (2015). <http://hdl.handle.net/10216/78353>

¹⁹Pérez-Arriaga, I., editor. “Chapter 9, Electricity Retailing”. *Regulation of the Power Sector*. Springer. (2013). ISBN: 978-1-4471-5033-6 (Print) 978-1-4471-5034-3 (Online) <http://www.springer.com/us/book/9781447150336>

²⁰Jesse D. Jenkins and Ignacio Pérez-Arriaga, *The Remuneration Challenge: New Solutions for the Regulation of Electricity Distribution Utilities Under High Penetrations of Distributed Energy Resources and Smart Grid Technologies*. CEEPR working paper, 2005. <https://mitei.mit.edu/system/files/20141015-The-Remuneration-Challenge-MIT-CEEPR-No-2014-005.pdf>

²¹Ignacio Pérez-Arriaga & Ashwini Bharatkumar, *A Framework for Redesigning Distribution Network Use of System Charges Under High Penetration of Distributed Energy Resources: New Principles for New Problems*. CEEPR working paper, 2014. <http://ceep.mit.edu/?wpdmdl=625%22%20%3E%3Ci%20class=>

The hyperlinks in this document were active as of April 2015.

Chapter 8 – Integration of Solar Generation in Wholesale Electricity Markets

This chapter explores the economic impact of large amounts of solar generation competing in free wholesale electricity markets with conventional thermal technologies. We do not seek to prescribe suitable regulatory and policy responses to the scenarios considered in this chapter, nor do we attempt to predict future prices and generation mixes. Furthermore, many detailed technical considerations — such as impacts on voltage stability, reserve capacity requirements, and the value of precise forecasting — are not included in this analysis.^{1,2,3} Rather, the chapter aims to develop general insights concerning the primary effects of large-scale solar production on different generation mixes in the wholesale electricity market over a medium-to-long-term time frame.

Our discussion of market integration issues is divided into seven sections. Section 8.1 introduces the main questions considered in this chapter and the general approach followed. Section 8.2 summarizes the general characteristics of solar photovoltaic (PV) generation and its interaction with electricity demand. Though the focus is on PV generation, the conclusions reached in this section also generally hold for concentrated solar power (CSP) without storage. In Section 8.3, we analyze the major short-to-medium-term impacts of increased PV production, focusing on a time scale that is sufficiently short that the high rate of solar PV deployment does not allow the generation technology mix to adapt. In Section 8.4, we consider a longer time scale, allowing changes in the generation mix (i.e., new investments

better adapted to a market with high levels of solar penetration). Additionally, we consider the impact of two key factors: (1) per-kilowatt-hour (kWh) support mechanisms for solar technologies and (2) the original composition of the technology mix (e.g., amount of hydro-power generation). In Sections 8.5 and 8.6, we briefly analyze the potential role of energy storage, including both energy storage that is external to PV facilities and energy storage incorporated in CSP power plants. Section 8.7 highlights major conclusions. Throughout this chapter we take final demand as given to highlight the wholesale-level challenges posed by substantial PV generation. Thus we do not model the use of dynamic pricing or other demand response techniques to reduce those challenges, even though demand response techniques have considerable potential to aid the penetration of solar generation.

8.1 INTRODUCTION

This chapter attempts to shed light on a question of increasing concern to stakeholders and policymakers: what will electric power generation systems — and, more specifically, wholesale electricity markets — look like if solar generation eventually becomes a significant or even dominant player? In broad terms, we examine how a significant penetration of solar generation could affect operations, planning, and market prices in electric power systems at the wholesale market level.

A major concern is the impact of solar PV on wholesale electricity prices. For instance, it is often said that a marginal-cost-based market mechanism will not make sense in the context of very high solar penetration, since prices will frequently be zero (or even negative if solar output is subsidized on a per-kWh basis) and new investments in necessary conventional generation will not be financially viable.

A major concern is the impact of solar PV on wholesale electricity prices.

We approach this subject in four steps:

1. We begin by reviewing the main characteristics of typical solar PV production profiles over time and explore their interactions with different electricity demand profiles.
2. Next, we investigate how solar generation can affect the market when PV systems deploy so rapidly that the rest of the technology mix does not have time to adapt. Specifically, we examine potential changes in the daily dispatch of various existing conventional power plants and the implications of these changes for the determination of market prices. To analyze these impacts, we simulate different levels of solar PV penetration in a power system with an already installed generation mix (see Appendix F for details).

3. We then examine how a massive penetration of solar generation could come to condition the future configuration of the generation technology mix, and what could be expected — in terms of impact on wholesale prices — from this new, adapted mix. Again, we simulate different levels of PV penetration over the same system, but we also allow the mix to optimally re-adapt to the new conditions imposed by the amount of solar PV that is present in each case.
4. Finally, we provide some insights into the key role that energy storage could play in facilitating the penetration of solar PV and other intermittent generation technologies.

To estimate how the system operation and generation mix might evolve with greater PV penetration, we analyzed a range of scenarios using the Low Emissions Electricity Market Analysis (LEEMA) model.ⁱ All simulations use 2030 as the reference year.

8.2 INTERACTIONS BETWEEN ELECTRICITY DEMAND AND SOLAR PHOTOVOLTAIC PRODUCTION

Since solar is a zero-variable-cost energy source,ⁱⁱ solar plants that lack energy storage capability will most likely be dispatched whenever they are available. This is also true for wind or run-of-river hydro and, in practice, it is also the case for some existing nuclear power

ⁱLEEMA is an optimization tool that solves for capacity expansion requirements and short-term operational needs in a fully integrated manner. The model was developed by researchers at Comillas University as part of the MITEI-Comillas collaboration (COMITES program) on the future of the electricity and gas sectors. A description of the basic structure of the model can be found in Batlle and Rodilla.⁴

ⁱⁱBecause the fuel to operate solar plants — i.e., sunlight — is free, the marginal cost of producing an additional kWh of electricity at an existing solar facility is zero. This is not generally true for conventional fossil fuel power plants.

plants, given their low variable cost and minimal operational flexibility. For low to medium penetrations of solar PV, the profile of the load that is left to be supplied by other technologies will be the direct result of subtracting solar production from total load (what is usually known as *net load*).ⁱⁱⁱ The ability of solar generators to reduce system operating costs and capacity requirements depends on the correlation between solar electricity production and electricity consumption.

Peak Load Reduction

Figure 8.1 shows an example of net electricity demand, in gigawatts (GW), on a typical summer day in 2030 at different (and increasing) penetration levels of solar PV within the Electric Reliability Council of Texas (ERCOT)^{iv} control area.

When annual peak loads are driven by summer daytime cooling demand (as is the case for ERCOT), higher levels of solar PV penetration reduce the annual net peak load. Specifically, Figure 8.1 shows that, as solar penetration grows, the net peak load progressively

decreases, narrows, and shifts in time (toward a few hours after sunset). At a certain point in the evening, net load stabilizes and is unaffected by any further increase in solar penetration until the next day.

As solar penetration grows, the net load peak progressively decreases, narrows, and shifts in time.

The situation is different when peak demand is dominated by winter loads (primarily for heating). This effect is predominant in the European case, but is not so relevant in the United States. All North American Electric Reliability Corporation (NERC) regions in the contiguous United States peak during the heavy air-conditioning summer months, except for the winter-peaking Northwest NERC region.⁵

Figure 8.2 shows loads for one typical winter day and one typical summer day in the United Kingdom in 2012 at several levels of solar PV penetration. In this case, annual net peak load is not reduced by solar PV generation because the net peak occurs after sunset.

Figure 8.1 ERCOT Net Load for a Typical Summer Day at Different Levels of Solar PV Penetration

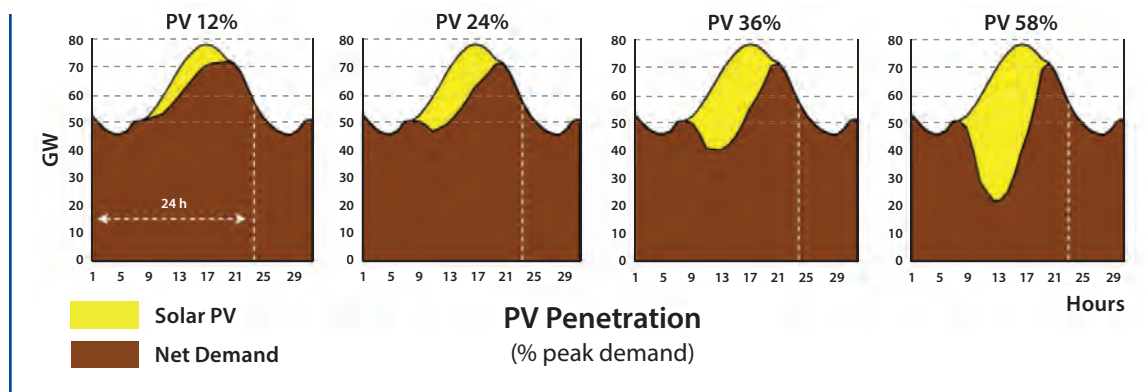

ⁱⁱⁱThis simple subtraction is not strictly the case for large penetrations of solar PV, which frequently require the curtailment of solar production for reasons that are discussed in a later section.

^{iv}ERCOT is one of several regional entities that are responsible for ensuring the reliability of the bulk power system across the United States; its control area covers most of the state of Texas.

Figure 8.2 Net Load for Different Penetration Levels of Solar PV in Winter and Summer in the United Kingdom

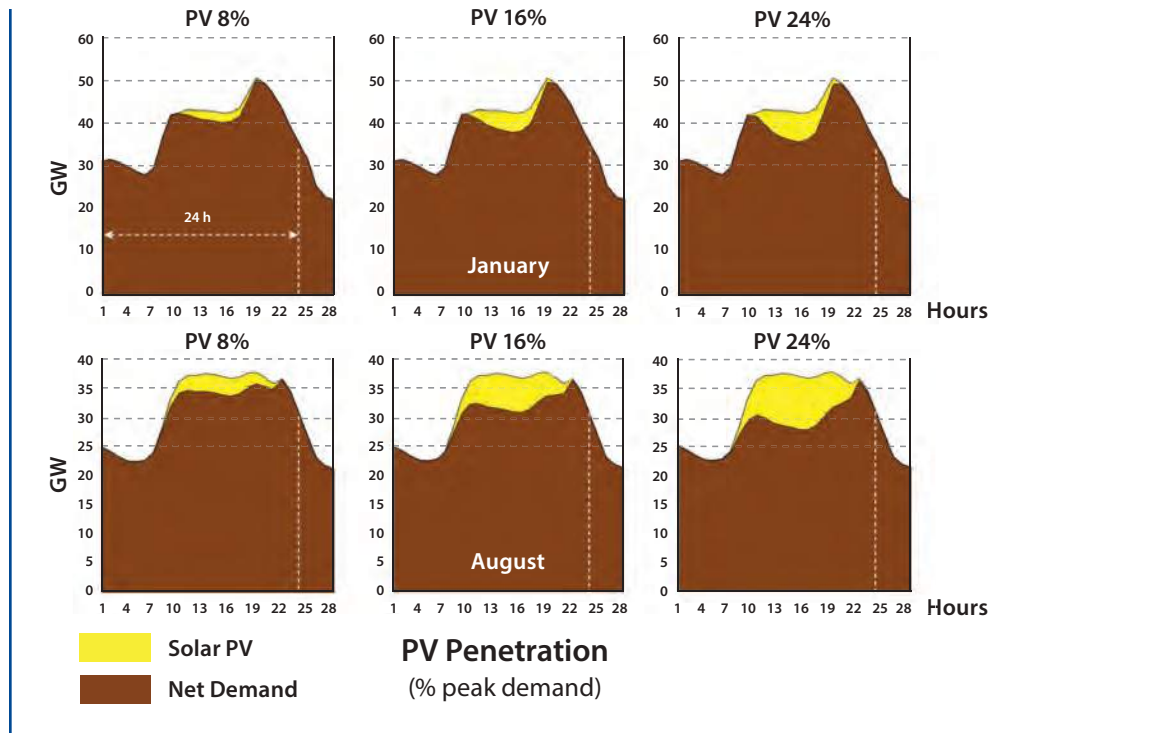

In sum, our analysis — described in more detail below — finds that solar generating facilities without energy storage reduce the power system’s overall capacity requirements only for moderate levels of solar penetration and for systems with summer annual peak loads.

FINDING

With a large penetration of solar PV, incremental PV does not significantly reduce the annual net peak load of the power system. Indeed, in regions where electricity demand peaks after sunset, adding PV generation without storage does not reduce annual peak load at all.

Valley Load Reduction

Figure 8.1 also shows that high levels of solar PV penetration can substantially reduce minimum daily net load. This minimum value, which appears as a load “valley” in the graph of net load, is relevant because it may limit the system operator’s ability to keep thermal plants operating. As is well known, keeping a number of units operating is not only economical, but is also essential to ensure that the system has enough spare capacity to respond in real time to deviations from expected levels of generation and demand.

Impact on Ramping Requirements

Different levels of solar PV penetration also affect the incremental change in net load variation between two consecutive hours (known as the hourly ramping value). Figure 8.3 shows how these hourly incremental changes would evolve in ERCOT's net hourly load for different increments of solar PV generating capacity. At low solar penetration levels, net load ramps are reduced. However, at higher penetration levels, the ramps become steeper and the daily pattern of ramps changes significantly. It is also worth noting that in some hourly periods, solar generation reverses the direction of the required ramp. Where an upward ramp was required, now a downward ramp is needed, and vice versa.^v

In purely thermal systems, increased ramping may increase operation costs for some generating units (e.g., non-flexible coal plants). At very high levels of solar PV penetration, the largest ramping needs usually occur just after net load falls to a minimum. The problem is that when net load is low (as a result of high solar PV production) many thermal units may be forced to shut down. Those units may not be available to immediately ramp up again. These two effects call for thermal flexibility: in other words, thermal generators must be able to start and stop frequently, to withstand large and rapid load variations from nominal value to minimum operating load (and vice versa), and to operate at lower minimum loads.

Figure 8.3 Hourly Net Load Ramps for Different Levels of Solar PV Penetration

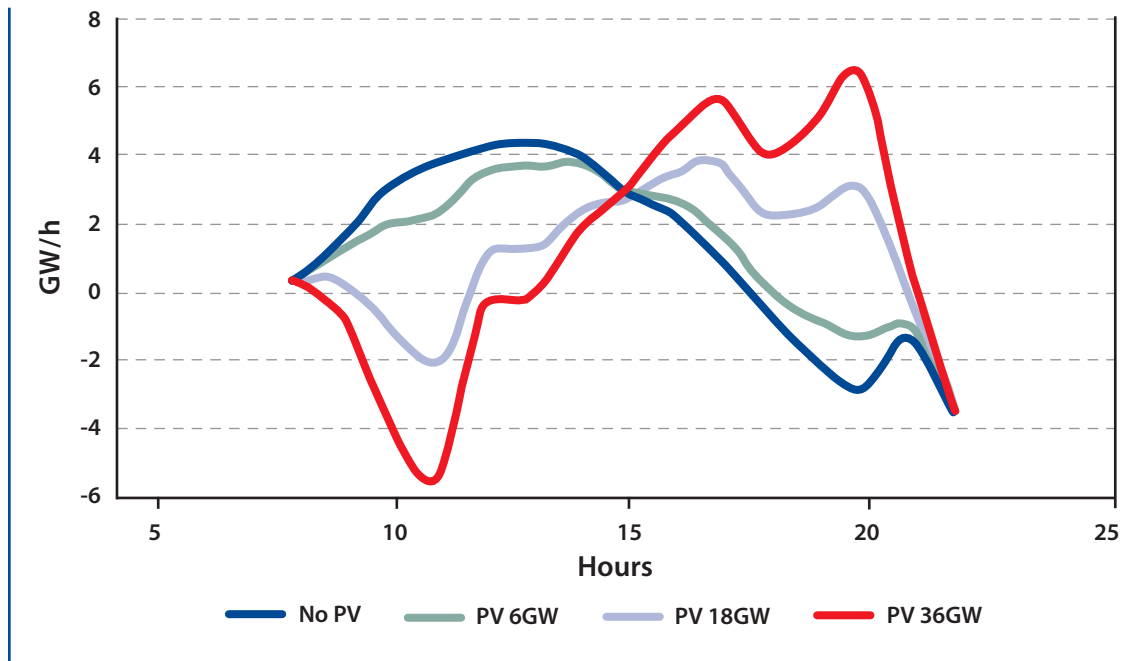

^vSimilar observations about ramping requirements apply regardless of the season of the year. The consequences of short-term variability and the uncertainty of PV production are discussed in Mills et al.⁶

A large and rapid increase in solar PV capacity will initially affect just the operation and profitability of existing thermal generating facilities.

8.3 SHORT-TO-MEDIUM-TERM IMPACTS OF SOLAR PV ON SYSTEM OPERATION, COSTS AND PRICES

Electricity output from plants that utilize variable energy resources (VERs) like wind and solar is more variable, less dispatchable, and less predictable than the output from conventional fossil- and nuclear-powered generation plants. Typically, VER capacity (particularly solar PV) can be deployed much faster than thermal technologies. Therefore, when considering only relatively short timescales, a large and rapid increase in solar PV capacity will initially affect just the operation and profitability of existing thermal generating facilities.^{7,8,9} Operational limits and the costs of cycling these facilities on and off are particularly relevant considerations in a near-term time frame, since some currently installed conventional thermal technologies (mainly coal plants but also some combined cycle gas turbine (CCGT) plants) were not expected to operate at the cycling regimes that are required by a strong presence of VERs in the resource mix generally, and a large PV presence in particular.

Two major short-to-medium-term effects on generation operation can be expected as a consequence of increasing VER penetration (ignoring the impact of potential transmission network constraints):

1. VERs, which have zero variable cost, tend to displace the most expensive variable cost units in the short term (such as fossil-fuel electricity generators).

2. At significant penetration, PV increases the cycling requirements imposed on conventional thermal plants. These plants are forced to change their output more frequently to meet load ramps associated with large changes in net demand. They have to decrease production to the minimum stable load for a higher number of hours, and they also have to start up and shut down more frequently.^{10,11}

FINDING

A large penetration of solar PV displaces the plants with the most expensive variable costs and increases thermal plants' cycling requirements.

Note that the cost impacts of these two operational changes act in opposite directions. While the displacement of high-variable-cost units tends to reduce costs (particularly fuel-related costs), the greater cycling demands on conventional thermal plants generally augments fixed operation costs (particularly costs related to starts, operations, and maintenance).

In a market context, these two operational changes also affect short-term price dynamics:

- Replacing fossil-fuel plants with VER plants at zero variable cost can change the marginal technology and thereby modify marginal prices. This is the so-called *merit order effect*, which tends to reduce wholesale electricity prices.^{vi}

^{vi}The “merit order effect” on prices has been qualitatively and quantitatively analyzed. See for example Sensfuß et al.¹² or Morthorst and Awerbuch.¹³

- On the other hand, as cycling intensifies, the operation of the system becomes more expensive. For example, the individual cost involved with each additional plant start-up usually rises as the total number of starts grows (due to wear and tear on plant equipment). The need to recover these increased costs will tend to result in higher prices.

The importance of these effects depends heavily on the generation mix. For example, if a particular technology dominates the generation mix, merit order effects can be less significant. This is the case for some European and U.S. systems (for example, in Spain and California), where CCGT technology accounts for a very large share of the generation mix.

FINDING

The impact of increased solar PV penetration on market prices and plant revenues depends on the pre-existing generation mix.

Changes in the Operating Regime

This section begins by examining the impact of different levels of solar PV penetration on the operating regime of conventional thermal plants. Specifically, our analysis considers two representative power systems, which are based on the actual systems in place in Texas and California.

This discussion focuses on results obtained by simulating the Texas ERCOT system; we present results from simulations of the California system only insofar as they provide additional insights. It is worth noting that our selection of these two cases is not meant to predict the future behavior of these specific systems, but rather to provide a realistic basis for analyzing two different generation mixes.^{vii} (The detailed data used in the simulations can be found in Appendix F).

In Texas, as in many other U.S. systems,^{viii} electricity demand exhibits a strong seasonal pattern, with far higher peak loads in summer than in winter. Using the forecast demand profile for 2030, Figure 8.4 shows the optimal (lowest cost) generation schedule for different levels of solar PV penetration in two representative summer and winter weeks. Here, solar penetration is measured as the ratio of installed PV capacity to system peak demand.^{ix} Although the figures show the operational implications of solar penetration levels from zero to, typically, around 40%, we do not mean to suggest that the highest levels of PV penetration shown represent an upper limit in any technical sense, particularly in a scenario where the generation mix has time to adapt.

Nuclear plants have the lowest variable cost of all thermal generation technologies and are often assumed to be totally inflexible from an operational standpoint.^x Therefore, they are run as purely base-load plants. In the baseline scenario (i.e., no solar PV), coal plants run at

^{vii}The modeling representation leaves aside many relevant details characterizing these systems (e.g., network, imports/exports, actual definition of ancillary services, etc.).

^{viii}See, for example, Corcoran et al.⁵

^{ix}The penetration level can also be measured as the ratio of solar production to total energy demand. To convert the capacity-based value used in the figures and tables to an energy-based value, a factor of 0.42 (ERCOT) or 0.40 (California) has to be applied. For instance, in ERCOT a penetration of 36% in capacity corresponds to 15% penetration in energy.

^xProperly designed or refurbished nuclear plants can be operated as flexible generators. However, with a few exceptions (e.g., in France and Germany), nuclear plants are usually operated in a pure base-load mode.

full capacity in both summer and winter during peak-load hours, but they follow different production regimes in summer and winter. While coal plants run at full capacity during most summer hours, they have to operate in a moderate load-following mode in winter. On the other hand, most CCGT production occurs in the summer. All CCGT plants operate at full capacity only during the summer peak-load

hours. In winter, when electricity demand is lower, only a small fraction of installed CCGT capacity is producing at peak hours.

In Figure 8.4, production from generators that provide operating reserves (CCGTs in this case) is shown below nuclear production. This reflects the fact that a certain amount of capacity always needs to be operating at partial

Figure 8.4 Impact on System Operation Regimes as Solar PV Penetration Increases (Summer and Winter)

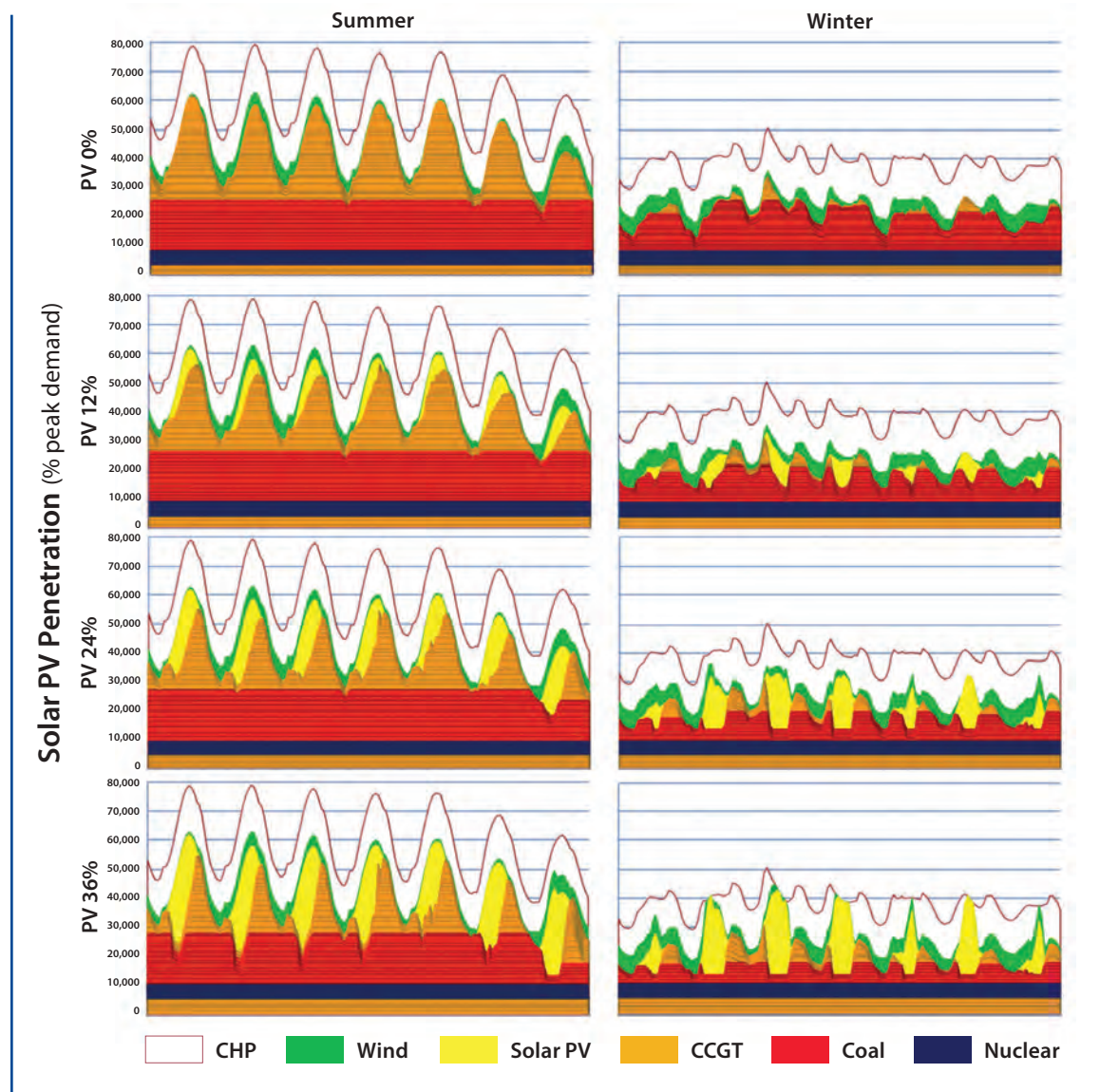

load so as to be able to provide upward and downward capacity reserves as needed to keep supply and demand on the system continuously balanced in real time. The contribution from combined heat and power (CHP) units in Figure 8.4 corresponds to actual CHP production profiles in ERCOT in 2012.

Several significant changes can be observed in Figure 8.4 as solar PV penetration increases:

- Solar PV production affects the already installed thermal generation mix to a different extent in summer and winter. In summer, solar production progressively reduces CCGT production, while in winter it affects coal production more significantly. As a result, coal units have to follow a much more seasonal operating regime, with some units not being dispatched at all during the winter.
- In a purely thermal system (as regards conventional generation), such as the one being analyzed here, the narrowing of demand peaks implies that an increasing number of units will need to produce during a small and decreasing number of hours. This could mean starting up a peak unit to produce for less than one hour. The costs of operating some units in this manner could be very high, resulting in electricity prices that are correspondingly high — e.g., above \$300 per megawatt-hour (MWh), as shown later in this discussion.

FINDING

In general, the higher the penetration of solar, the less production there will be from less flexible generation technologies. This effect is more acute in the season with the lowest levels of net demand.

Solar PV production affects the already installed thermal generation mix to a different extent in summer and winter.

- In general, coal production is more seriously affected than CCGT production at very high solar penetration levels. This is due to the lower cycling capability of coal plants, which generally are not designed to start up once a day. For systems with a large coal contribution (e.g., ERCOT), this effect can be relevant. On the other hand, it would be less of an issue in California or New England, just to mention two systems with only a small amount of coal production. Furthermore, when demand follows a strong seasonal pattern, as in the case of ERCOT, increasing solar penetration leads to a much more active cycling regime for thermal power plants in the low demand season (winter in this case), thus leaving less room for coal production in that part of the year.

In general, coal production is more seriously affected than CCGT production at very high solar penetration levels.

- The larger the solar PV presence, the larger the system's operating reserve requirements, leaving less flexible plants to meet system demand.^{xi} This reduces overall system flexibility.⁹
- At high levels of solar penetration, the system must accommodate a large supply of non-dispatchable, zero-variable-cost production during several hours (with solar production adding to wind and CHP production in the simulation). This can significantly increase cycling needs and costs, thus making it economically efficient to “spill” some portion

^{xi}Operating reserves are calculated as the sum of the capacity of the largest thermal plant in the system, 0.5% of peak load and 0.2% of the installed capacity of intermittent generation. For the sake of simplicity, we assume that a constant amount of upward and downward reserves is required in all hours.

of the zero-variable-cost resource (in the simulation, this situation occurs mainly in winter, though it also occurs, to a lesser extent, in the summer). Roughly speaking, it is more cost efficient to not use all available zero-variable-cost production rather than force a coal plant to stop operating, only to start the coal plant up again a couple of hours later. Figure 8.5 shows the optimal level of curtailment as solar penetration increases for two scenarios: in one scenario VER generators do not receive any per-kWh incentive (so curtailment is exclusively driven by economic considerations);^{xii} in the other scenario, the per-kWh incentive is so high that all VER production is used as long as doing so does not threaten the overall security of supply (threats to supply security could come from low operating reserve margins, for instance,

or from the need to shut down a nuclear power plant). The figure shows the total amount of zero-variable-cost energy to be spilled, without entering into any discussion of the preferred merit order for curtailment (i.e., which types of generators — CHP, wind, or solar — should be curtailed first).

FINDING

At high levels of solar PV penetration, it will be increasingly necessary to curtail production from solar facilities (and/or from other zero-variable-cost generators) to avoid costly cycling of thermal power plants.

Figure 8.5 Economic Curtailment of Zero-Variable-Cost Energy

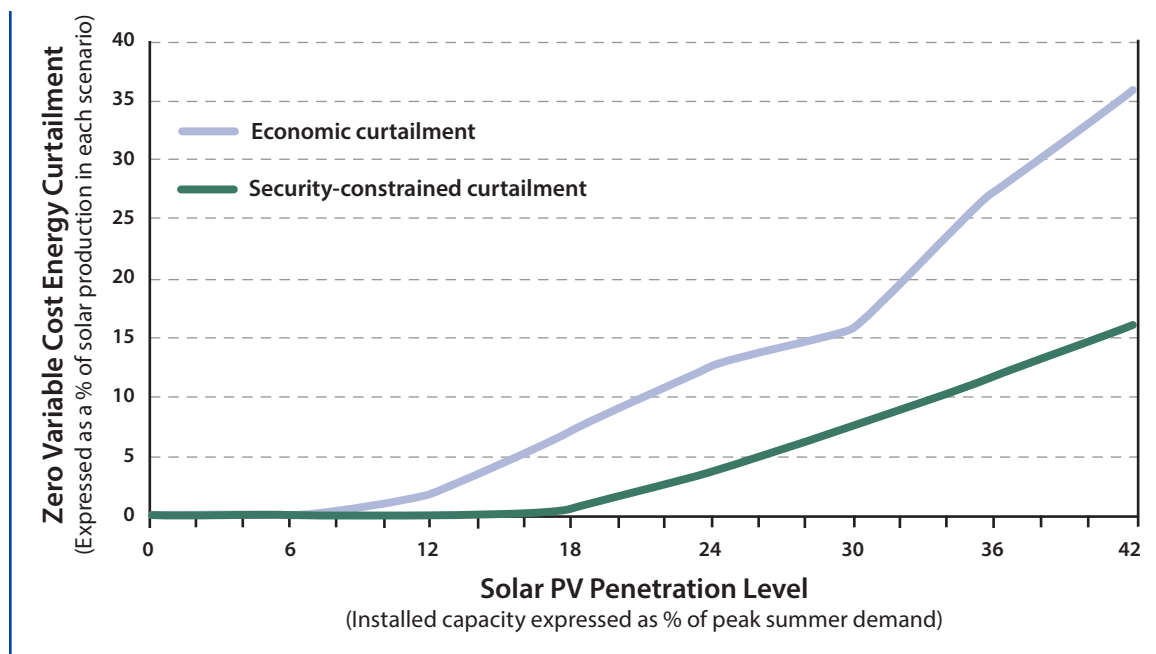

^{xii}In a market context, this sort of curtailment entails prices that are zero or, in the extreme, negative, which would involve spilling all zero-variable-cost energy.

- Figure 8.6 shows total annual electricity production by technology as installed solar PV capacity increases. At low penetration levels, solar production affects both CCGT and coal production. At higher penetration

levels, solar affects coal more seriously. Indeed, for very high penetration levels, we can observe a substitution effect between CCGT and coal.

Figure 8.6 Annual Electricity Production as a Function of Installed Solar PV Capacity

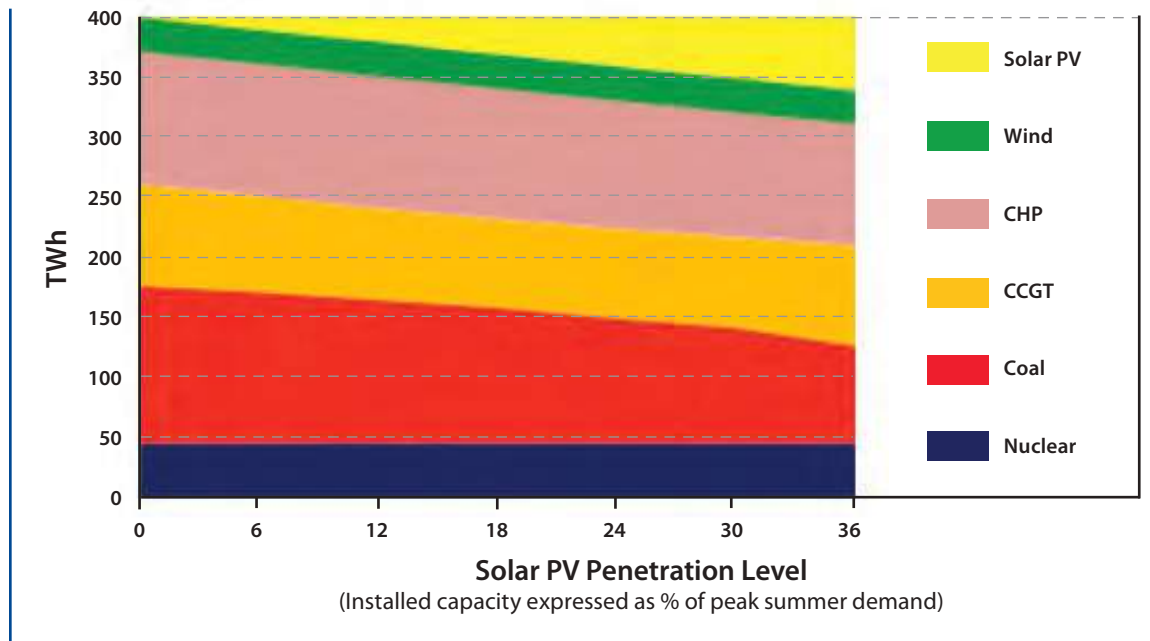

Changes in Production Costs

Absent energy storage capability, high levels of solar penetration result in the curtailment of a growing fraction of zero-variable-cost energy and a significant increase in the average operating costs of the conventional thermal plants that are subject to frequent cycling.^{xiii} The evolution of total short-term thermal production costs (i.e., not including investment costs)

After solar reaches a certain penetration level, the average cost of each MWh produced with conventional technologies increases because of higher cycling costs.

as solar PV penetration increases is shown in Figure 8.7a. Notably, the rate of reduction of production costs with solar PV penetration diminishes smoothly.

Figure 8.7b shows average short-term production costs for thermal generators only (in \$/MWh) as solar penetration increases. At low levels of solar penetration this average cost decreases, as output from solar generators replaces output from the thermal plants with the highest variable costs via the merit order effect. After solar reaches a certain penetration level, however, this trend reverts and the average cost of each MWh produced with conventional technologies increases because of higher cycling costs.

Figure 8.7 Changes in Total Short-Term Thermal Costs as a Consequence of Solar PV Penetration

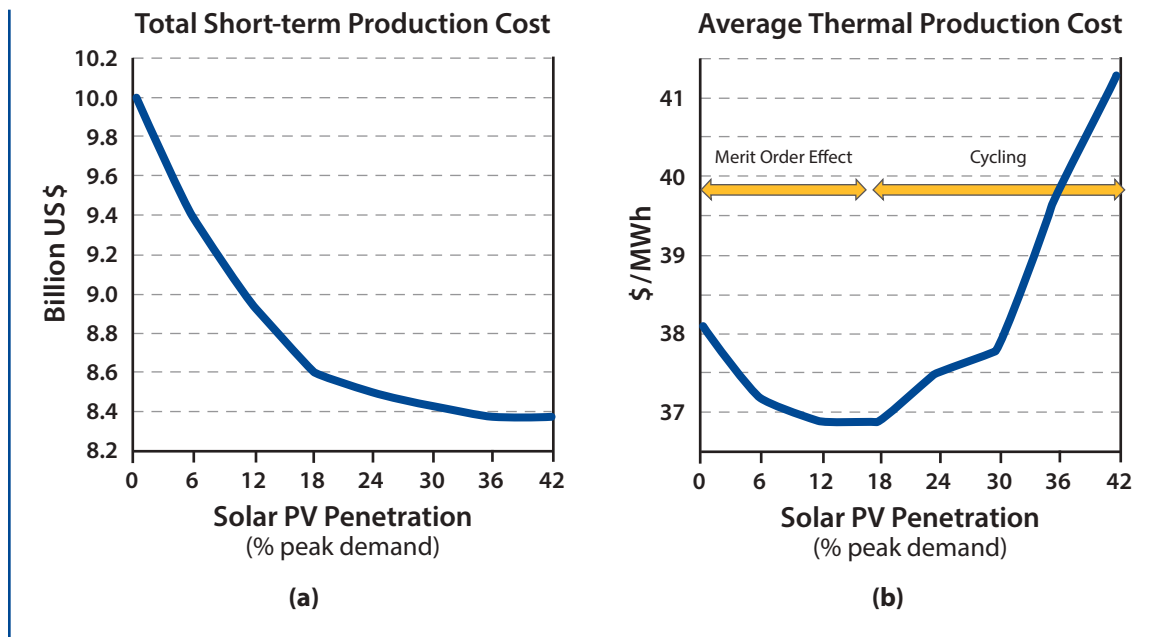

^{xiii}Sections 8.5 and 8.6 show how the addition of energy storage could modify this picture.

Changes in Market Prices

Figure 8.8 shows the evolution of average market prices with increased PV penetration when no new generation capacity is installed. The graph shows a generally declining trend, indicating that the merit order effect prevails. However, this trend starts to revert slightly at very high levels of solar penetration, when there is an increase in the number of hours during which CCGT plants set the market price — to the detriment of coal generators, which start to disappear entirely because of their limited operational flexibility. A secondary effect that pushes prices up at high levels of solar PV penetration is the effect of cycling on production costs (particularly as a result of high costs related to unit start-up).

Note that these changes in market prices will generally affect the profitability of existing generators. This is particularly the case when capacity investments were made based on price expectations that assumed a low or non-existent solar contribution.

Figure 8.9 shows how a strong solar presence in the overall generation mix significantly changes the location and magnitude of peak prices for a particular day (corresponding to a Friday in summer, as demarcated by the dotted-line rectangular shape in the figure). In particular, high prices would be expected to coincide with

Peak price increases with higher levels of solar PV penetration.

net peak demand hours. Since solar shifts the time of net peak demand, it also shifts the timing of peak prices. The figure further shows that peak price increases with higher levels of solar PV penetration. This is because of higher costs for the operation of thermal generating units and narrower peak periods. On the other hand, prices fall in the two hours when the marginal technology changes from CCGT to coal.

Figure 8.10 portrays the annual price-duration curve.^{xiv} While prices tend to decrease with higher levels of solar PV penetration during valley and shoulder demand hours, this is not the case during peak hours when a strong solar presence slightly raises prices. No price limits

Figure 8.8 Evolution of Average Market Prices

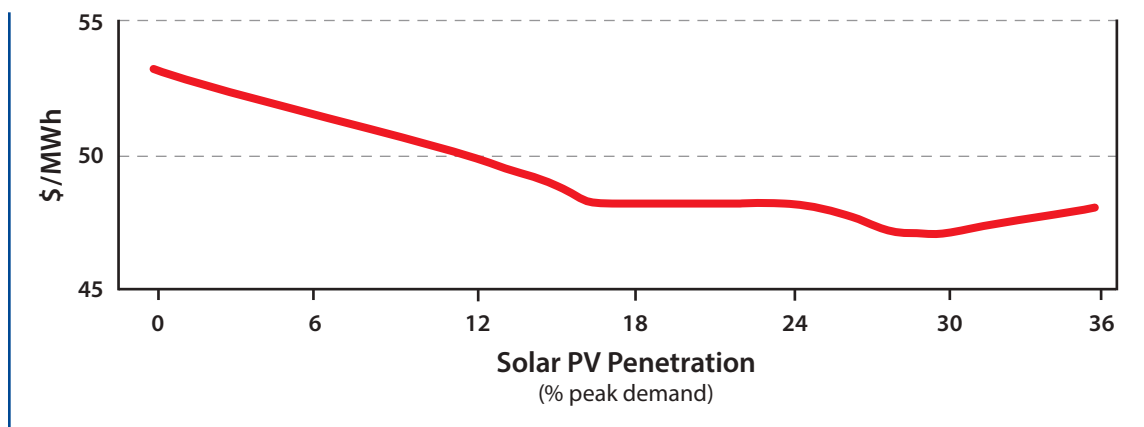

^{xiv}In the price-duration curve, annual hourly prices are sorted in descending order, so that the curve starts from higher values and is monotonically decreasing. The price-duration curve is useful for finding the number of hours that a certain price was exceeded in the simulation.

Figure 8.9 Evolution of Peak Prices Due to Increasing Solar Penetration

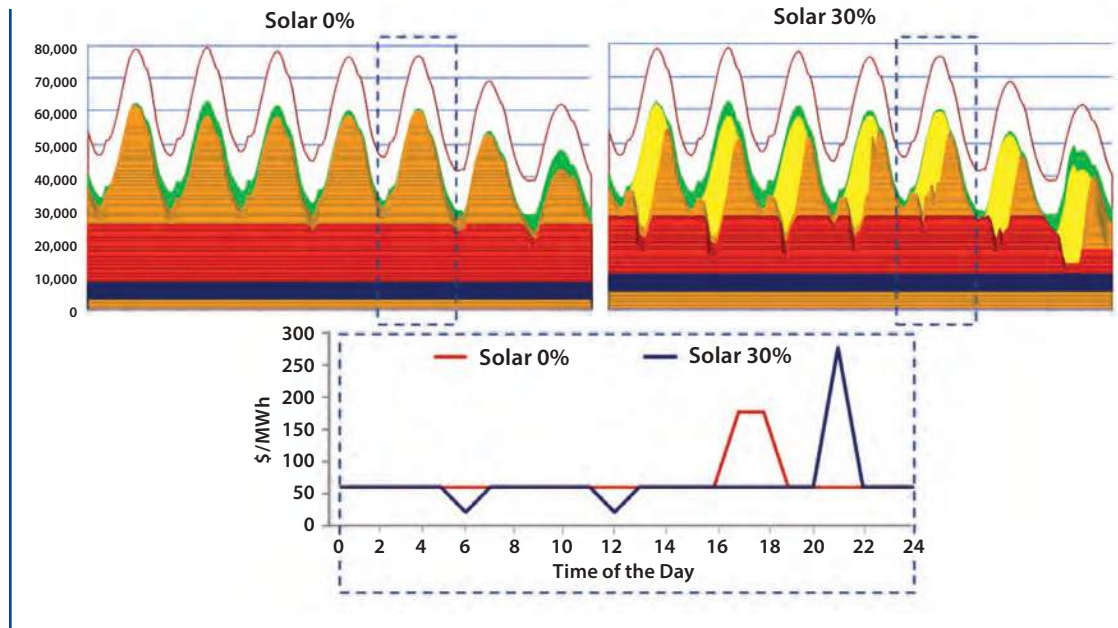
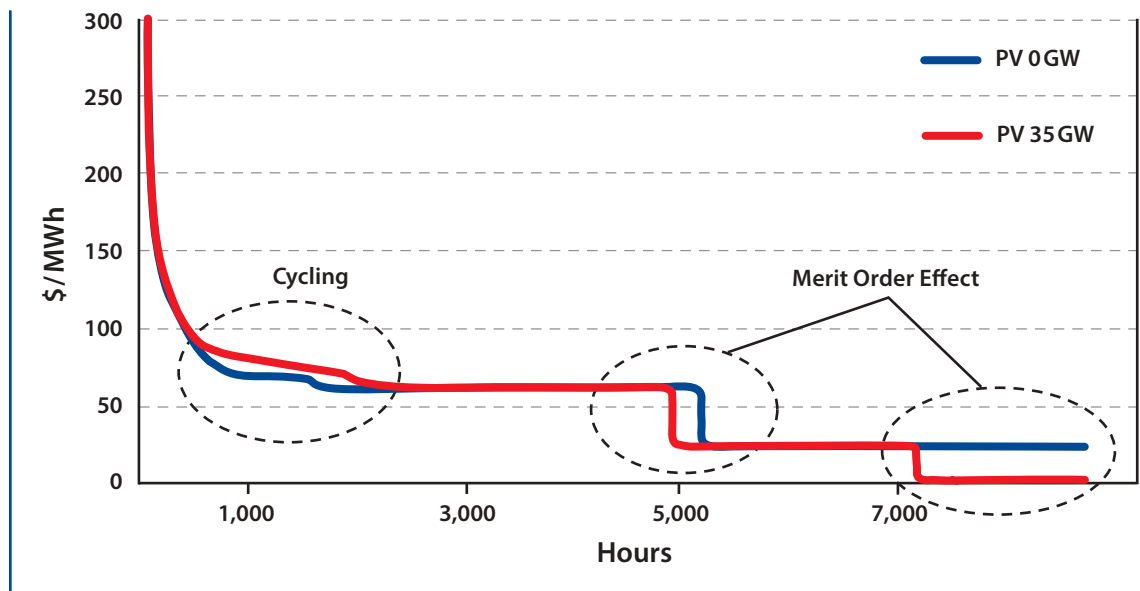

Figure 8.10 Price-Duration Curves for Two Scenarios of Solar Penetration



were imposed in these simulations, but it is worth noting that most actual electricity markets have price caps. In the particular case of ERCOT, the price cap can barely be considered a limit since it was set at \$7,000 per MWh

at the time of this writing (the ERCOT price cap is expected to increase to \$9,000/MWh in 2015). In the European electricity market, there are plans to implement a homogenous EU-wide €3,000/MWh price cap.

Revenues of Solar PV Generators under Competitive Market Conditions

One of the major concerns presently being expressed by stakeholders is whether, in a system with a competitive wholesale electricity market, a cost-competitive solar PV technology would, by itself, either stop further capacity investments at a certain penetration level, or end up completely flooding the electric power system with uncontrolled amounts of zero-variable-cost energy.

Increased solar PV penetration has a variety of impacts on wholesale market prices, as we have just seen. It is noteworthy, however, that as a result of basic supply-and-demand dynamics, solar capacity systematically reduces electricity prices during the very hours when solar generators produce the most electricity.^{xv} Beyond low levels of penetration, an increasing solar

contribution results in lower average revenues per kW of installed solar capacity. For this reason, even if solar generation becomes profitable without subsidies at low levels of penetration, there is a system-dependent threshold of installed PV capacity beyond which adding further solar generators would no longer be profitable.

Beyond low levels of penetration, an increasing solar contribution results in lower average revenues per kW of installed solar capacity.

Figure 8.11 depicts the effect of increasing solar PV penetration on average revenues per unit of solar energy produced. Since solar energy is produced in periods of relatively high demand, the prices perceived by owners of solar generation are initially high in comparison to the average system price. However, as net load

Figure 8.11 Average Market Prices and Average Prices as Perceived by Owners of Solar Generation

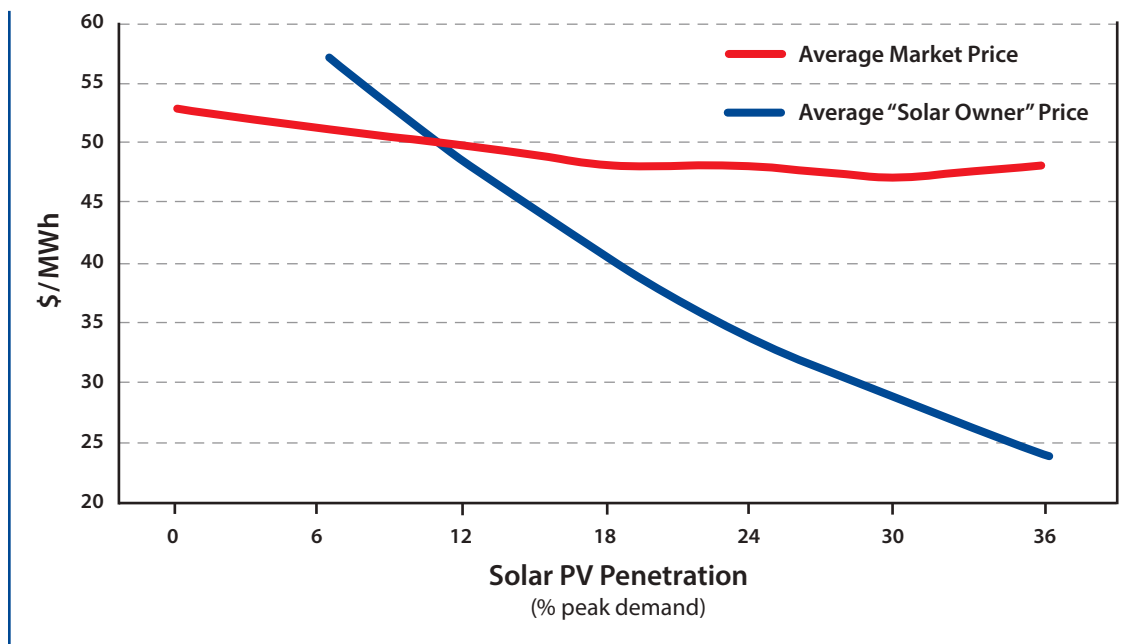

^{xv}We have seen how prices may increase as a consequence of incremental cycling-related costs. Note that these prices occur during hours when solar resources are not available. Therefore, solar PV cannot benefit from this effect on prices.

diminishes with increasing solar production, market prices can fall rapidly during these hours.^{xvi} At high levels of penetration, solar plants will produce during many zero-price hours. The figure can also be seen from a different perspective. By comparing annual average solar production costs (in \$/MWh, where these production costs include investment plus operating costs) to annual per-MWh plant revenues, it is possible to estimate the amount of solar capacity (in GW) that would be naturally installed in an open, competitive market.

At high levels of penetration, solar plants will produce during many zero-price hours.

Role of Hydro Resources in Short-Term Operation

As we show next, there are valuable synergies in the joint availability of dispatchable hydro resources along with the non-dispatchable solar PV resources. For instance, the limited but dispatchable energy from flexible hydro resources (as from any other type of stored energy) generally makes it possible to reduce the net peak load that would otherwise occur around sunset. However, these synergies are obviously conditioned by the maximum output available from hydro generators and by the amount of energy that can be stored in reservoirs.

FINDING

Even if solar PV generation becomes cost competitive at low levels of penetration, revenues per kW of installed capacity will decline as solar penetration increases until a breakeven point is reached, beyond which further investment in solar PV would be unprofitable.

In our simulation of a California-like system, the baseline scenario (with no PV contribution) shown in Figure 8.12 clearly illustrates the characteristic peak shaving dispatch of hydro plants. Net peak loads are not always completely covered by hydro generation because these plants have maximum outputs. Absent these output limits, access to hydro resources would make it possible to completely flatten net peak loads.

Hydro dispatch during the summer and winter weeks in the 25% PV scenario shown in Figure 8.12 helps illustrate what the joint availability of non-dispatchable solar and dispatchable hydro can and cannot achieve. We begin by focusing on the summer week, when the positive synergy between both technologies is easily observed.

^{xvi}See Hirth¹⁴ for further evidence supporting this argument.

Figure 8.12 Operational Impact of Hydro Resources in the California-Like System

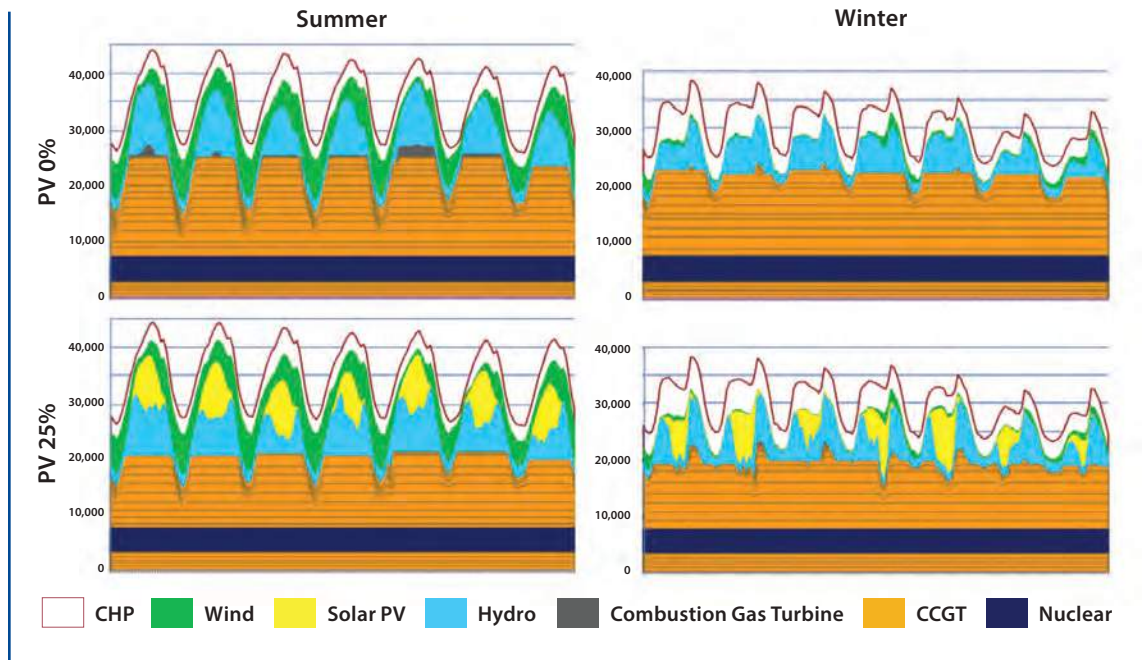

Hydro units can be dispatched in such a way that the resulting net peak load is reduced by the combination of hydro and solar generation. That is, during this week, solar seems to “add” energy and maximum output to the hydro dispatch. This enhanced peak shaving further displaces the most expensive variable cost units (merit order effect) while also reducing cycling requirements for conventional generators.^{xvii}

FINDING

Positive synergies can be achieved by jointly coordinating hydro and solar production in ways that help reduce net peak loads and cycling requirements for thermal generators.

However, optimal peak shaving is only possible when dispatch is not constrained by limits on the maximum output of hydro plants. This constraint can be illustrated using simulation results for some winter weeks. In the baseline scenario, we see that limits on hydro output leave the system with a net demand peak in the daily peak period. In this case, adding production from solar generators outside the peak period cannot be used to reduce net demand peaks. Coordinating solar and hydro resources in the winter, while still possible, is therefore less effective than coordinating these resources in the summer.

Although not shown in the figure, maximum power production from hydro facilities in the scenarios with installed PV capacity above 15 GW no longer allows for complete peak shaving in the summer. This results in a net load situation analogous to that described for winter.

^{xvii}The higher the share of high-variable-cost units, such as diesel generators or gas turbines, the larger the savings that can be derived from this improved peak shaving capability.

8.4 LONG-TERM IMPACTS OF SOLAR PV ON TECHNOLOGY MIX, OPERATION, COSTS, AND PRICES

Analyzing the long-term impacts of a larger solar presence in the electricity generation mix requires adding a further dimension to the previous analysis: potential changes in the technology mix in response to the growing role of intermittent generators. As above, each simulation treats the level of PV capacity as given, regardless of whether revenues to PV generators would cover their costs. However, we do show (in Figure 8.23) the break-even level of solar PV costs per watt installed, given the revenues that PV facilities could expect to generate based on wholesale market energy prices.

A large-scale expansion of VER capacity will condition to a large extent the expansion of other generation technologies because of the effects of a large VER presence on conventional plants' operating regimes and therefore on system-wide production costs and prices.

A large-scale expansion of VER capacity will condition to a large extent the expansion of other generation technologies.

The goal of the simulation discussed in this section is to assess how changes in the generation mix in response to the increased penetration of solar and other VER technologies can affect the economics of electricity systems and the way they function. In contrast to the simulations described in the previous section, we recalculated the optimal non-solar generation mix for each scenario modeled in this

portion of the analysis. Thus, the impacts calculated for different levels of solar penetration are driven not only by changes in system operation, but also — and more importantly — by changes in the generation mix.

Specifically, we find that three different but interrelated effects account for the long-term impact of increased solar PV penetration on electric power systems: (1) the merit order effect, (2) changes in cycling requirements for thermal plants, and (3) changes in the mix of generation technologies.

To examine long-term impacts, we assume that, consistent with current plant retirement plans, a significant portion of today's installed capacity will be decommissioned by 2030. Appendix F identifies the power plants that are assumed to still be operating in 2030 in our analysis.

Plant decommissioning creates a deficit in generating capacity that needs to be covered by new investments. Therefore, we first analyze the technologies that can be expected to cover that gap. Afterwards, we examine the resulting market outcomes.

Impacts on Capacity Expansion and Operation

Figure 8.13a shows how the optimal mix of capacity investments in the ERCOT-like system changes at higher levels of solar penetration. CCGT and combustion gas turbine (CGT) technologies constitute the only new capacity installations.^{xviii} Figure 8.13b charts annual production from these new investments. It is clear that CGT plants have low utilization factors (these units are mainly used to serve peak demand in the summer).

^{xviii}No new coal plants are added in any scenario because the installed capacity of this technology is already higher than optimal.

Figure 8.13 Evolution of Installed Capacity and Annual Production by Technology (ERCOT-Like System)

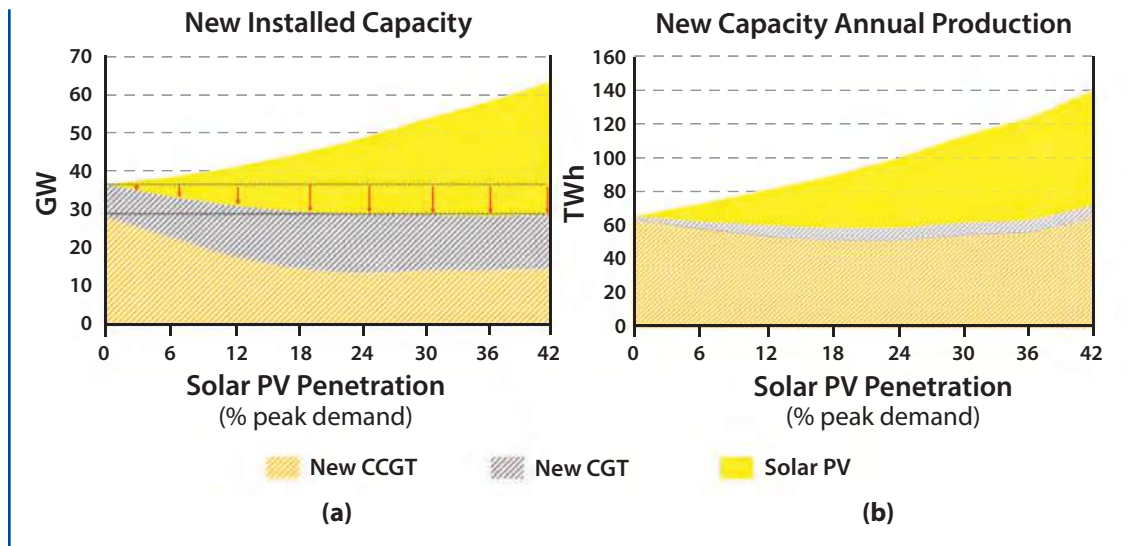

A noteworthy finding from the figure is that total requirements for new thermal generating capacity decline when low levels of solar capacity are introduced. This reduction (marked with red arrows in Figure 8.13a) reflects the capacity value of solar PV; beyond a certain point it clearly reaches a saturation level due to solar PV’s limited ability to reduce the system’s net peak load.

FINDING

Hydro production increases the capacity value of solar generators at low levels of PV penetration.

The Role of Existing Hydro Resources in the Long-Term Expansion Problem (California-like System)

We also examined the evolution of the generation mix assuming a much larger role for solar PV^{xiv} in the more flexible California-like system (Figure 8.14). Several relevant differences from the ERCOT case are worth highlighting:

- In the California context, the capacity value of solar PV is enhanced at low levels of penetration because of the flexible hydro resources available in the system. Figure 8.15 shows the contribution of solar PV in terms of reducing new thermal capacity requirements in both systems in a magnified form for quick comparison.
- The flexibility of hydro plants dramatically reduces the need for CGT peaking units, which have higher operation costs than CCGT plants.

^{xix}Only new thermal investments are evaluated; hydro capacity is assumed to remain constant.

Figure 8.14 Evolution of Installed Capacity and Corresponding Annual Energy Production (California-Like System)

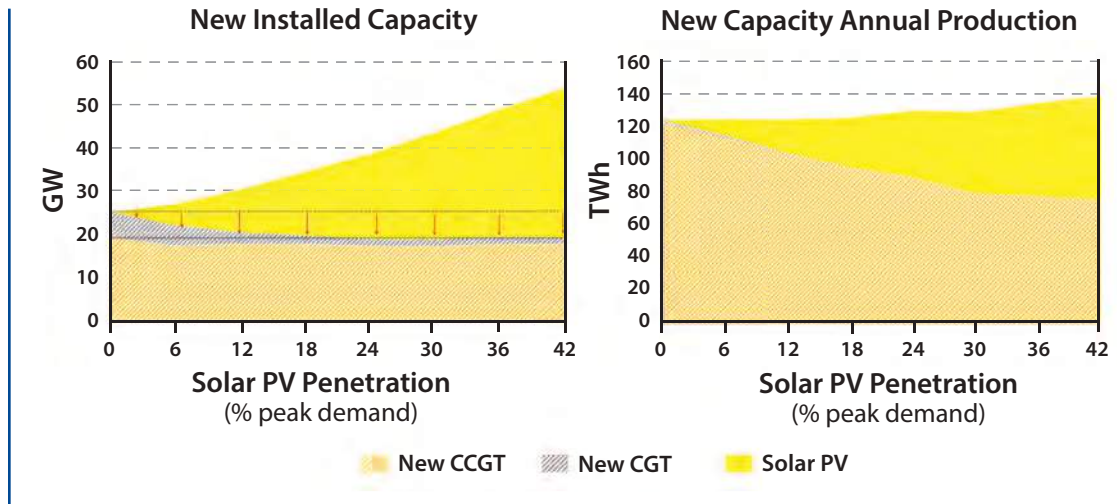
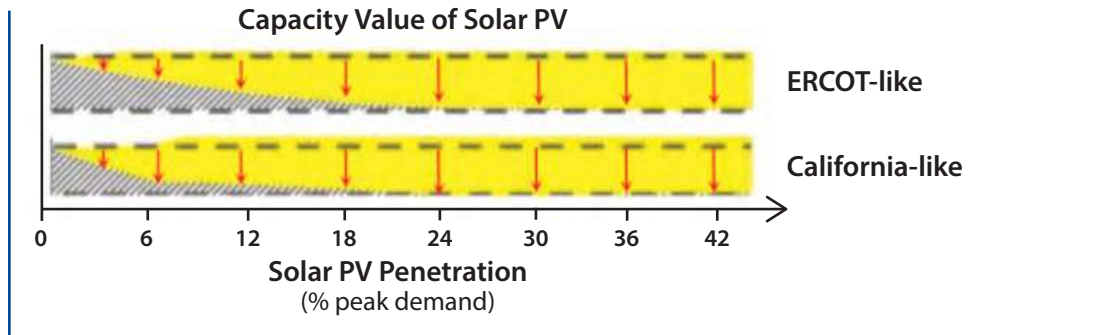

Figure 8.15 Capacity Value of Solar PV in the ERCOT and California Systems



Impacts on Long-Term Production Costs

Figure 8.16 shows the evolution of total long-term production costs (including annualized capital costs) for thermal generators as solar PV penetration increases in the ERCOT-like system. Again, although production costs decrease at higher levels of solar penetration, the rate at which they decrease also slows down.

Impacts on Prices

Figure 8.17 presents average wholesale prices in the ERCOT-like system. It is clear that these results are quite different from those obtained in the previous section, when we did not consider that the generation mix could be adapted in response to increased solar penetration. Solar penetration increases the need for low-capital-cost CGT plants. These CGT plants

Figure 8.16 Changes in Long-Term (Thermal) Production Costs as a Consequence of Solar PV Penetration (ERCOT-Like System)

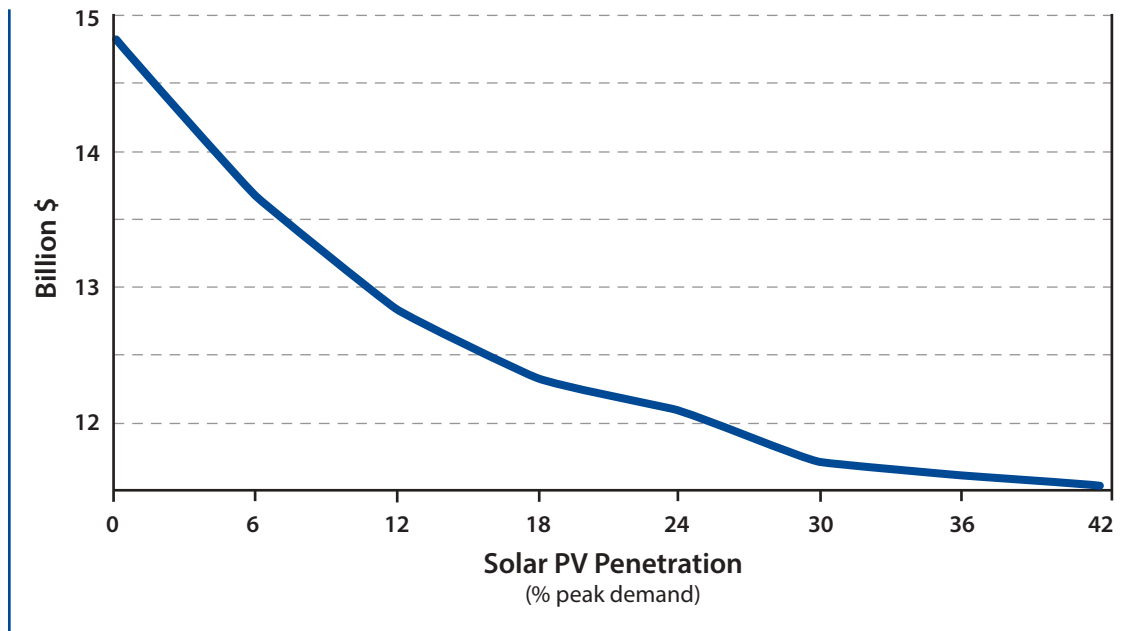
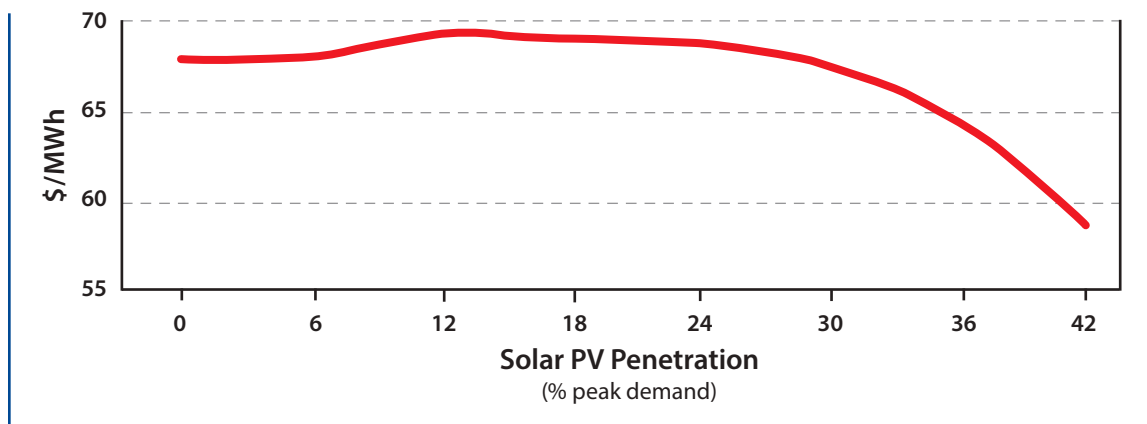

Figure 8.17 Evolution of Average Wholesale Market Prices



produce mainly during peak hours, where they obtain a higher price than that found in the baseline scenario with no PV.^{xx} This effect, coupled with an increase in cycling requirements, tends to compensate for the merit order effect. At very high levels of penetration, the merit order effect weighs more heavily in the final results, and average prices decrease.

Despite a predicted decline in average prices as solar penetration increases, the model calls for some investment in CCGT and CGT plants, meaning that even in the high solar penetration scenarios these technologies are still financially viable. One of the reasons is that these plants, because they operate as peaking units, receive above-average prices for their output.

^{xx}A larger amount of CGT installed capacity (even in the 0% solar scenario) leads to average prices that are significantly above those presented in the short-term analysis, where no CGT was installed.

FINDING

Despite a decline in average wholesale prices due to high solar PV penetration, it remains profitable over the long term to invest in thermal plants (mainly CCGT and CGT).

Impacts on Hourly Spot Market Prices

In the ERCOT-like system, prices are lower during shoulder and valley demand hours as a consequence of the merit order effect (see Figure 8.18). However, in high demand hours, prices tend to increase due to two effects: changes in the generation mix (higher CGT utilization, which has higher variable costs) and increased cycling of thermal plants.

Price-duration curves corresponding to 3,500 hours of higher demand in the California-like system are shown in Figure 8.19. There is no systematic increase in prices during these higher demand periods because, as previously discussed, the presence of hydro capacity in this system prevents the installation of CGT. An increase in prices during the 250 hours of highest net demand reflects the effect of increased thermal plant cycling.

Additionally, although this result is not shown in the figure, it is worth noting that solar PV depresses prices in the lower demand hours. This leads to a total of 2,927 hours with zero prices when installed solar capacity reaches 35 GW (prices are never zero in the case without solar PV).

Figure 8.18 Price-Duration Curves for Two Scenarios of Solar Penetration (ERCOT-Like System)

Figure 8.19 Price-Duration Curves for Two Levels of PV Penetration (California-Like System)



Effect of Production-Based Regulatory Support Schemes for VERs

In the short term, the distorting market effects of a fixed \$/kWh production-based support mechanism for solar generators and other VERs will obviously depend on the level of the incentive itself. If the incentive is large enough, all renewable energy production will be put on the market. This therefore reduces the amount of renewable output that would be otherwise curtailed for economic reasons (i.e., to minimize total operation plus investment costs at a given level of solar PV penetration) and leads to more inefficient (and costly) operation of the system in the short term.^{xxi}

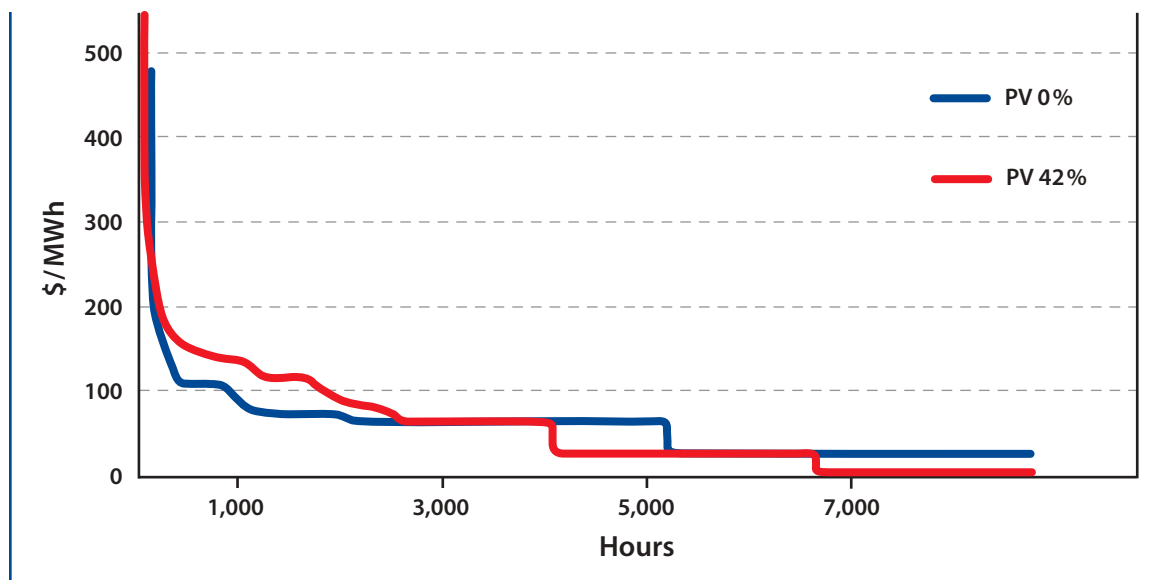
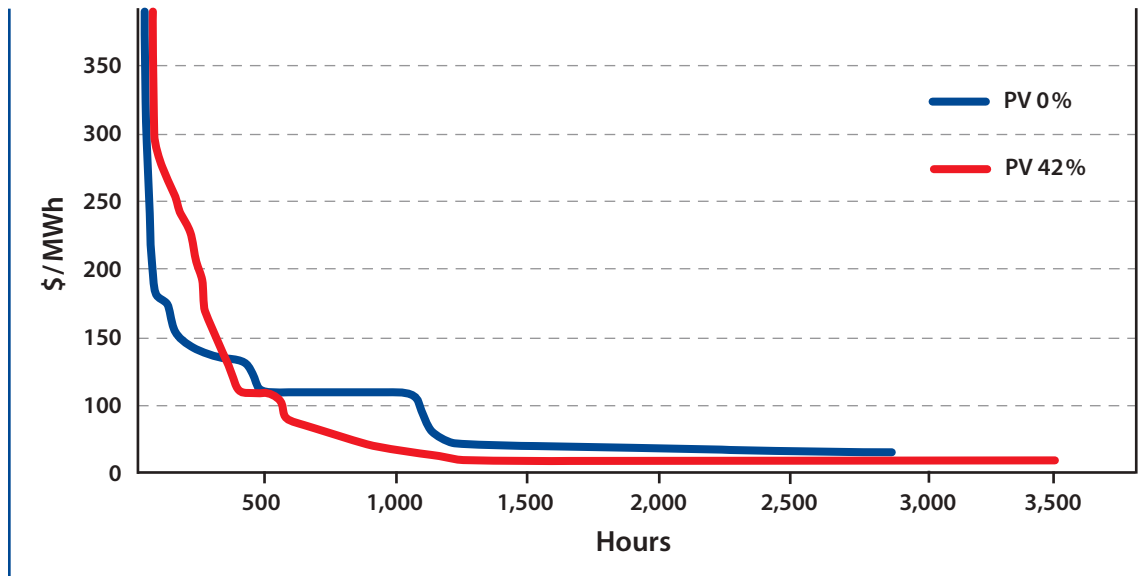
Figure 8.20 shows annual production in the ERCOT-like system for both extreme cases: the case with no support mechanism (Figure 8.20a) and the case with a very high per-kWh production subsidy (Figure 8.20b). The impact of

The impact of subsidies mainly affects inflexible technologies (coal), and also requires new investments (mainly in CCGT capacity) to cover the gap left by coal.

subsidies mainly affects inflexible technologies (coal), and also requires new investments (mainly in CCGT capacity) to cover the gap left by coal. It is noteworthy that forcing a small amount of production that should have been economically curtailed (the area in solid blue), affects a much larger quantity of coal production.

FINDING

At high levels of solar PV penetration, production subsidies lead to short-term inefficiencies in system operation and changes in the generation mix.

^{xxi}As discussed in Chapter 9, a \$/kWh subsidy can be designed in ways that avoid such distortions. One alternative is to give an incentive that is proportional to market price, which would yield zero returns whenever the price is zero. Another approach would be to prohibit solar generators from bidding negative prices.

Figure 8.20 Annual Production by Technology Type with and without Solar Production Subsidies

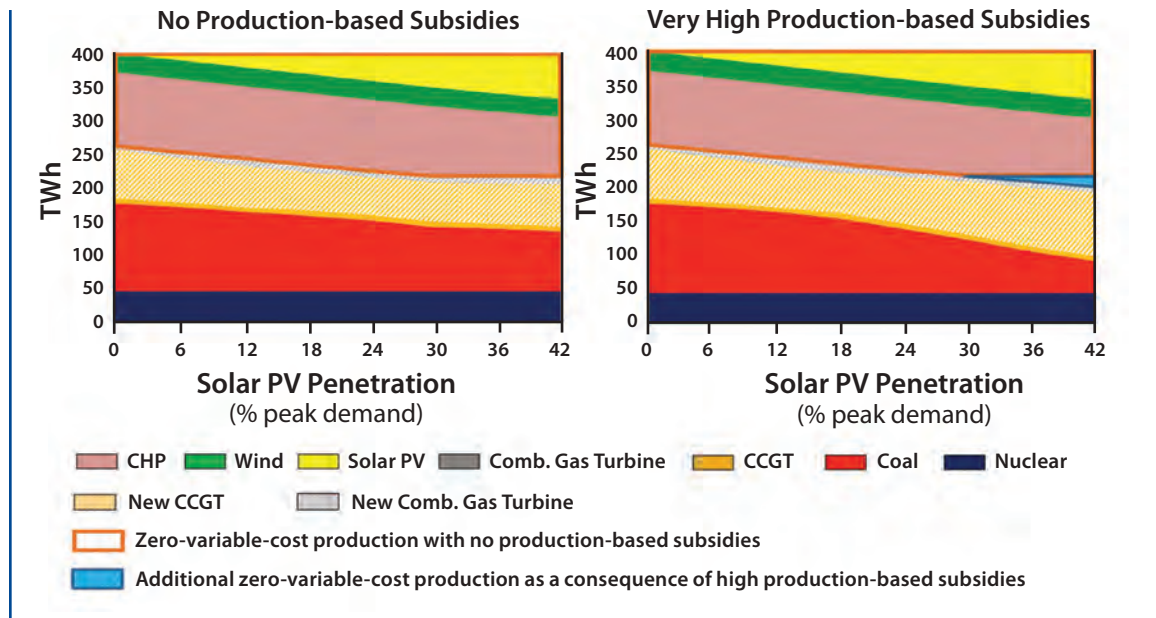

8.5 CONCENTRATED SOLAR POWER WITH STORAGE CAPABILITY

As discussed in Chapters 3 and 5, concentrated solar power (CSP) thermal plants can easily add (thermal) energy storage. Indeed, designing CSP plants to allow for energy storage typically lowers short-term generation costs by permitting more efficient operations and by enabling continued power output after sunset. Adding CSP facilities with thermal storage or other grid-level storage could aid the integration of solar PV. Roughly speaking, the addition of energy storage serves two potential uses:

- Energy storage can be used to increase the solar contribution during net peak load periods. Qualitatively, this use of stored energy is analogous to the use of hydro plants. The only difference is that, because of technical

limitations, it may be more difficult to use thermal energy storage in CSP plants to produce electricity during net peak loads that occur before sunrise (Figure 8.21 shows a net load profile for high and low levels of PV penetration). To use stored energy to supply those peaks, CSP plants would need to be capable of retaining energy for the following day.

- The other alternative is to use stored thermal energy in CSP plants to produce throughout the night and during the early morning. Though prices are not usually high during the night and early morning, this approach has advantages both in terms of preventing the thermal storage fluid from solidifying (in the case of molten salts, for instance) and in terms of avoiding the need to stop and then re-start the turbine a few hours later.

Figure 8.21 Dispatch of CSP with Storage Capability in Two PV Penetration Scenarios

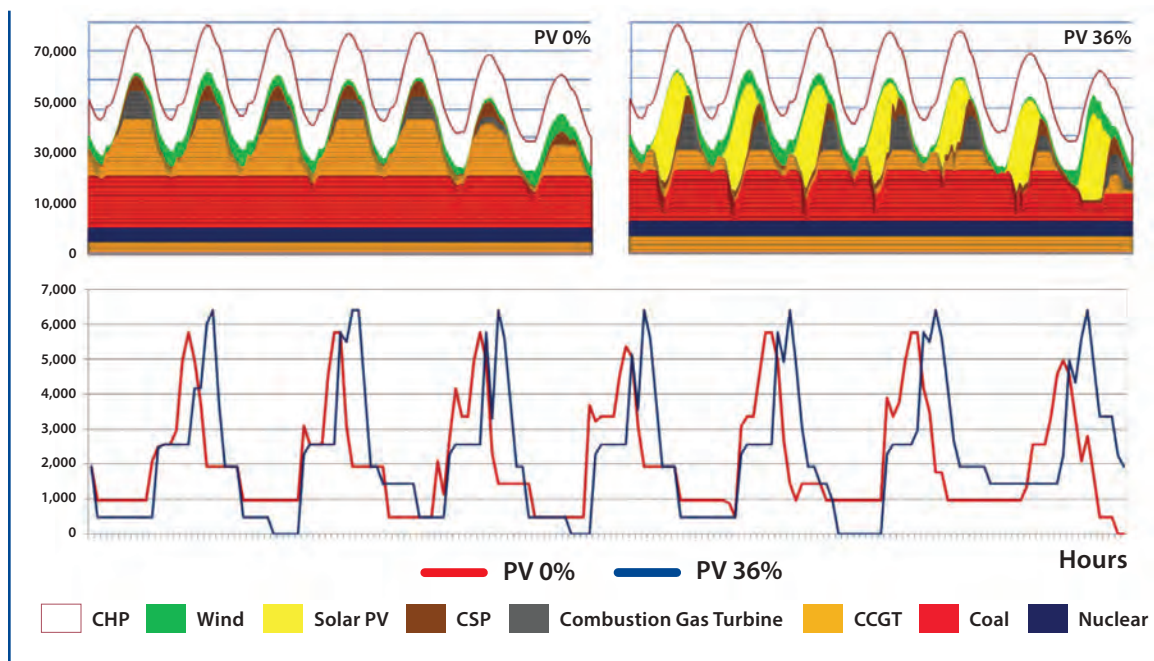

Depending on prices and technical conditions, stored energy from CSP plants could be used either way.

Figure 8.21 shows the simulated dispatch of CSP with thermal energy storage (TES) for two extreme scenarios: a scenario with no solar PV and a scenario with 30 GW of installed solar PV. The lower section of the chart compares the behavior of the CSP plant in both scenarios. In particular, the figure shows how larger amounts of stored CSP energy are available to supply peak loads in the scenario with high levels of PV penetration. Note that these model results are based on a predefined solar profile and on a set of assumptions concerning the most relevant technical characteristics of the CSP plant, including solar field thermal power, TES capacity (4 hours of storage), steam turbine minimum and maximum generation levels (we assume the minimum is one-third of the

maximum), start-up energy requirements, and other start-up related costs. See Denholm¹⁵ for a detailed description of the meaning of these parameters.

8.6 THE ROLE OF ENERGY STORAGE

At a wholesale level, the large-scale deployment of solar PV poses two major challenges: it results in lower net load valleys and produces narrower and steeper peak periods. As discussed in previous sections, these changes in the traditional load profile lead to an increase in cycling requirements for existing thermal plants and also to higher peak capacity requirements (because peak capacity is usually provided by units with high variable operating costs, this results in higher prices during peak periods when these units are producing).

Hydro resources can help deal with new net peak load periods in high PV penetration scenarios, but they do not help solve the problem created by lower load valleys. Technologies that offer energy storage capability can help to deal with both issues. Indeed, storage can aid the integration of larger amounts of solar PV in a free competitive market context by increasing the market remuneration for solar generation in low net load periods (when solar PV production is usually at a maximum).

We do not discuss the economics of different energy storage alternatives. Rather we focus on the benefits that storage provides, first from the perspective of the whole system, and second from the point of view of solar generators. These benefits can be achieved by introducing any technology that is capable of shifting net load from peak periods to valley periods (for example, load shifting can also be accomplished with demand side management).

Storage technologies take advantage of low prices during valley hours to store energy that can later be used to produce electricity during peak load hours. Figure 8.22 shows simulation results for a scenario in which some daily energy storage facilities (e.g. pumped hydro stations) are added to the ERCOT-like model system. The roundtrip efficiency for producing electricity from these storage facilities is assumed to be 0.7.^{xxii} The figure shows results for four cases corresponding to different levels

of maximum daily energy storage; specifically, 20, 40, 60, and 80 GWh.^{xxiii} Figure 8.22 shows the resulting dispatch of different generation resources, including stored energy, during a typical summer week. The figure shows how valley demands increase, helping some units produce at higher output levels and also reducing cycling requirements. At the same time, some CGT production is avoided during peak net load periods.

Energy storage thus has two major effects on prices. It increases prices during demand valleys (because valley demand increases) and it reduces prices during peak demand periods. In light of our earlier observation that as solar penetration increases, solar PV does not produce during peak net load hours, the most significant price effect of energy storage from the point of view of solar PV generators is an increase in prices during valley periods.

FINDING

At high levels of solar PV penetration, the addition of energy storage facilities benefits solar PV owners by increasing wholesale prices during load valleys and thereby increasing the market remuneration PV owners receive for electricity delivered during these periods.

^{xxii}Roundtrip efficiency represents the relationship between the electricity generated divided by the electricity consumed by the storage facility.

^{xxiii}Given that average daily electricity consumption in ERCOT totals 1,100 GWh, 20, 40, 60, and 80 GWh of production using stored energy corresponds to about 1.8% , 3.6% , 5.4%, and 7.2% of overall system requirements.

Figure 8.22 Impact of Energy Storage on the Hourly Dispatch of Different Generation Resources

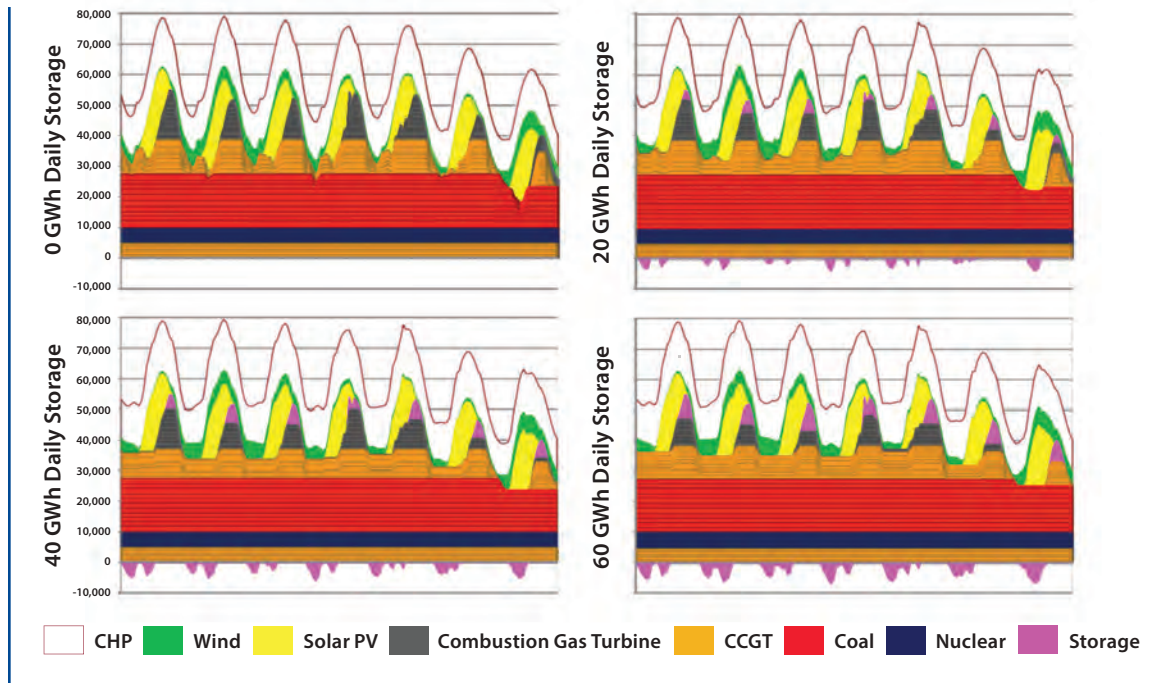
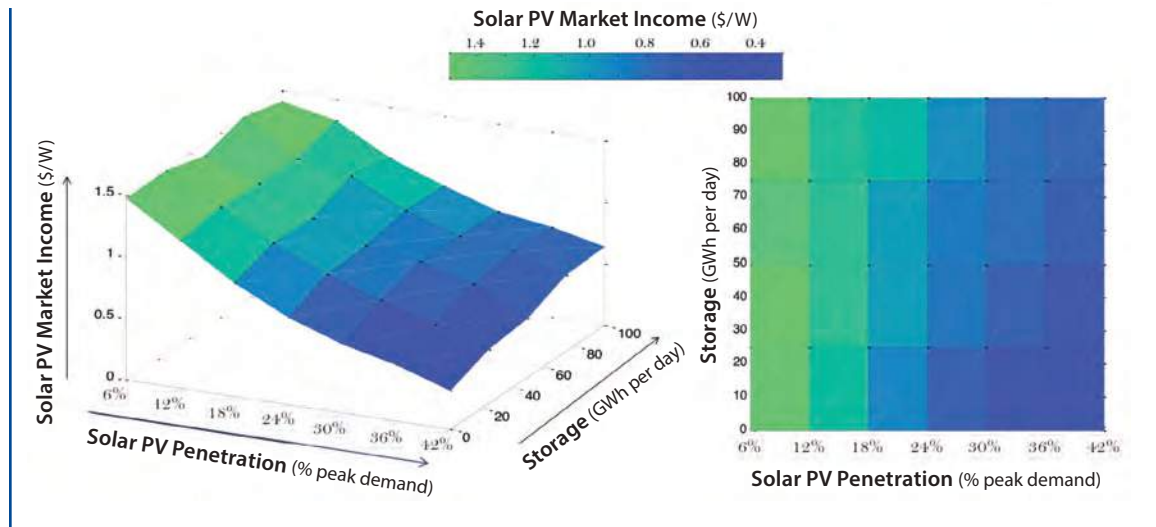

Figure 8.23 shows total revenues from solar PV production (per installed watt) at wholesale energy market prices, for each combination of solar PV penetration level and daily energy storage capability. This result can also be interpreted as the break-even cost of solar PV, at wholesale market prices, for each combination. Except for very low levels of PV penetration, the larger the quantity of added energy storage capability, the higher the revenues generated by PV plants and therefore the higher the profitability of PV investments at any level.

Except for very low levels of PV penetration, the larger the quantity of added energy storage capability, the higher the revenues generated by PV plants and therefore the higher the profitability of PV investments at any level.

Figure 8.23 Market Remuneration for Solar PV Production (in \$/W) as a Function of PV Penetration and Energy Storage Capability



8.7 SUMMARY AND CONCLUSIONS

Our analysis of the expected economic impacts — at the wholesale market level — of having large amounts of solar generation fully integrated and competing in electricity markets points to several major findings. We conclude the chapter by summarizing these findings.

Interactions between Electricity Demand and Solar PV Production

Absent the ability to store energy for later use, solar PV generators — because they have zero variable operating costs — will most likely be dispatched whenever the sun is shining. Therefore, the load profile that is left to be supplied by other technologies can be determined by simply subtracting solar production (assuming this production is not subject to curtailment) from total load to yield a quantity that is usually referred to as *net load*. Analyzing

net load helps to anticipate some of the major system impacts that would be expected to emerge at higher levels of solar PV deployment:

- The absolute net peak load, which is usually taken as a good proxy of the additional capacity needed on top of solar PV to supply system demand, can only be reduced when annual peak loads occur during the day.^{xxiv} Even if this is the case, the reduction in absolute net peak load is very limited and does not continue to grow at higher levels of solar PV penetration.
- The daily minimum net valley load value can decrease for high levels of solar penetration. This can be a problem for thermal plants that try to avoid shutting down by producing at the minimum level of output technically required to maintain stable operation during valley periods.

^{xxiv}This is the usual case in most regions of the United States, where annual peak loads are driven by summer air-conditioning loads. However, in regions where system demand is dominated by winter loads, solar PV will not reduce annual demand peaks because these peaks tend to occur after sunset, when no solar production is available.

- Low levels of solar PV penetration reduce net load ramps (the hourly increment or decrement of net energy demanded). At higher levels of penetration, however, ramping loads usually increase.

Main Short-Term Impacts of Solar PV on System Operation

In the short run, a large increase in solar PV production will reduce generation from plants with the highest variable costs, while also increasing cycling requirements for thermal plants. In terms of cost (and price) impacts, these two changes act in opposite directions: reduced generation from high-variable-cost units tends to reduce costs and prices, while greater cycling requirements tend to increase cost and prices. Which effect is more pronounced depends strongly on the existing generation mix. If the existing mix is relatively flexible, cycling effects will be less relevant. In particular, these effects can be significantly alleviated when the system has access to significant hydro resources or energy storage facilities. Although not analyzed in this chapter, demand response and strong interconnections with neighboring power systems are also known to have similarly mitigating effects on cycling requirements.

It is also worth noting that in purely thermal systems, the narrowing of net demand peaks implies that a number of units will need to start up to produce for a very small number of hours. This will have a material impact on prices, which will increase in these periods. Higher levels of solar PV deployment will generally reduce the profitability of pre-existing generation investments.

Main Long-Term Impacts of Solar PV on System Operation

In the long term, a growing solar PV presence will force the overall generation mix to adapt so as to better cope with increased cycling requirements. As a general rule, and in the absence of highly flexible generation options (e.g., hydro or storage), increased cycling needs coupled with a reduction in the utilization of thermal plants will prompt investment in more flexible peaking units with lower capital costs. The availability of flexible hydro resources can soften these short-term impacts, reducing the need for peaking units (in favor of more installed capacity of CCGTs rather than CGTs, for example).

Higher levels of solar PV deployment will generally reduce the profitability of pre-existing generation investments.

Solar PV's contribution to reducing system-wide capacity needs (as reflected in so-called capacity value or capacity credit) is strongly related to its ability to reduce annual net peak load. Our analysis finds that solar PV does not significantly reduce annual net peak load in otherwise purely thermal systems. In addition, we find that once PV is deployed on a large scale, further additions of installed PV capacity have very little effect on thermal capacity requirements. In this respect, the presence of hydro resources can slightly enhance the capacity value of solar resources.

Main Impacts of Solar PV on Market Prices

In purely thermal systems, the presence of large-scale solar PV — besides increasing short-term price volatility — tends first and foremost to reduce average market prices in general. At the same time, solar PV tends to increase peak prices in peak net load periods, which tend to occur around sunset in systems with a high penetration of PV resources. In systems with substantial hydro capacity, impacts on price volatility and the latter effect on peak net load prices are less relevant.

In purely thermal systems, the presence of large-scale solar PV — besides increasing short-term price volatility — tends first and foremost to reduce average market prices in general.

It is worth noting that price reductions from solar PV production are systematically most significant during the same hours when solar generators deliver maximum output. As a consequence, higher levels of solar penetration lead to lower revenues per kW of installed solar capacity. For this reason, at any given per kW installation cost of solar PV, there is a system-dependent threshold or limit beyond which adding further increments of PV capacity will not break even from a cost perspective.

At any given per kW installation cost of solar PV, there is a system-dependent threshold or limit beyond which adding further increments of PV capacity will not break even from a cost perspective.

If, in the long term, the generation mix adapts to higher levels of solar PV by installing more peaking capacity (this would be the expected trend in thermal systems), prices could increase

Production-based incentives lead to more inefficient (and costly) operation decisions in the short term and to a more inefficient generation mix in the long term.

during peak load periods as a consequence of higher variable costs to operate the new marginal technology. In any case, assuming the market is not affected by distorting regulatory intervention (e.g., price caps), our modeling exercise shows that no matter the level of PV penetration: (a) new capacity will be added to the system as needed to readjust the overall generation mix and (b) investors in new units will fully recover their investment costs.^{xxv}

Potential Inefficiencies Stemming from Production-Based Support Mechanisms

Production-based support mechanisms — such as per-kWh incentives — can reduce the (economic) curtailment of output from solar and other renewable generators and lead to inefficiently high levels of solar energy production in systems with large amounts of PV capacity. The distorting effect of such production-based support mechanisms on the short-term market obviously depends on the size of the incentive. If the incentive is large enough, all renewable energy production will be matched and scheduled in the market. Production-based incentives lead to more inefficient (and costly) operation decisions in the short term and to a more inefficient generation mix in the long term.

^{xxv}In a properly functioning market, any unit that is needed to minimize long-term system costs should ideally represent a profitable investment — in other words, marginal prices should provide adequate incentives for needed capacity investments.

REFERENCES

- ¹Milligan, M., P. Donohoo, D. Lew, et al., “Operating Reserves and Wind Power Integration: An International Comparison.” National Renewable Energy Laboratory. Conference Paper NREL/CP-5500-49019, Oct 2010. In *Proceedings 9th International Workshop on Large-scale Integration of Wind Power into Power Systems*. <http://www.nrel.gov/docs/fy11osti/49019.pdf>
- ²Lew, D., M. Milligan, G. Jordan, and R. Piwko, “The Value of Wind Power Forecasting.” Conference Paper NREL/CP-5500-50814, April 2011. In *91st AMS Annual Meeting, 2nd Conference on Weather, Climate, and the New Energy Economy Proceedings, Washington, DC*. (2011). <http://www.nrel.gov/docs/fy11osti/50814.pdf>
- ³Gautam, D., V. Vittal, and T. Harbour, “Impact of Increased Penetration of DFIG-based Wind Turbine Generators on Transient and Small Signal Stability of Power Systems,” *IEEE Transactions on Power Systems*, 24, 3 (2009): 1426-1434. <http://dx.doi.org/10.1109/TPWRS.2009.2021234>
- ⁴Battle, C., and P. Rodilla, “An Enhanced Screening Curves Method for Considering Thermal Cycling Operation Costs in Generation Expansion Planning,” *IEEE Transactions on Power Systems*, 28, 4 (Nov 2013): 3683-3691. http://ieeexplore.ieee.org/xpls/abs_all.jsp?arnumber=6527360&tag=1
- ⁵Corcoran, B. A., N. Jenkins, and M. Z. Jacobson, “Effects of Aggregating Electric Load in the United States,” *Energy Policy* 46 (2012): 399-416. <http://dx.doi.org/10.1016/j.enpol.2012.03.079>
- ⁶Mills, A., et al., “Understanding Variability and Uncertainty of Photovoltaics for Integration with the Electric Power System.” Lawrence Berkeley National Laboratory. LBNL Paper LBNL-2855E. (Dec 2009). <http://escholarship.org/uc/item/58z9s527>
- ⁷Holttinen, H., et al., “Impacts of Large Amounts of Wind Power on Design and Operation of Power Systems, Results of IEA Collaboration,” *Wind Energy* 14, 2 (Mar 2011): 179-192. <http://onlinelibrary.wiley.com/doi/10.1002/we.410/full>
- ⁸Cailliau, M., et al., “Integrating Intermittent Renewable Sources into the EU Electricity System by 2020: Challenges and Solutions.” Euroelectric (2010). http://www.euroelectric.org/media/45254/res_integration_paper_final-2010-030-0492-01-e.pdf
- ⁹Pérez-Arriaga, I. J., and C. Battle, “Impacts of Intermittent Renewables on Electricity Generation System Operation,” *Economics of Energy and Environmental Policy* 1, 2 (Mar 2012): 3-17. <http://www.iit.upcomillas.es/docs/IIT-12-013A-Preview.pdf>
- ¹⁰Troy, N. E., Denny, and M. O’Malley, “Base-load Cycling on a System with Significant Wind Penetration,” *IEEE Transactions on Power Systems* 25, 2 (2010): 1088-1097. http://ieeexplore.ieee.org/xpls/abs_all.jsp?arnumber=5373907&tag=1
- ¹¹Rodilla, P., S. Cerisola, and C. Battle, “Modeling the Major Overhaul Cost of Gas-Fired Plants in the Unit Commitment Problem,” *IEEE Transactions on Power Systems* 29, 3 (May 2014): 1001-1011. http://ieeexplore.ieee.org/xpls/abs_all.jsp?arnumber=6681955
- ¹²Sensfuß, F., M. Ragwitz, and M. Genoese, “The Merit-order Effect: A Detailed Analysis of the Price Effect of Renewable Electricity Generation on Spot Market Prices in Germany,” *Energy Policy* 36, 8 (2008): 3086-3094. <http://dx.doi.org/10.1016/j.enpol.2008.03.035>
- ¹³Morthorst, P. E., and S. Awerbuch, “The Economics of Wind Energy.” A Report by the European Wind Energy Association. Søren Krohn Ed. (Mar 2009). <http://citeseerx.ist.psu.edu/viewdoc/download?doi=10.1.1.397.7663&rep=rep1&type=pdf>
- ¹⁴Hirth, L., “The Market Value of Variable Renewables: The Effect of Solar Wind Power Variability on Their Relative Price,” *Energy Economics* 38 (2013): 218-236. <http://www.sciencedirect.com/science/article/pii/S0140988313000285>
- ¹⁵Denholm, P., Y.-H. Wan, M. Hummon, and M. Mehos, *An Analysis of Concentrating Solar Power with Thermal Energy Storage in a California 33% Renewable Scenario*. NREL/TP-6A20-58186. (Mar 2013). http://0101.nccdn.net/1_5/100/308/1c7/NREL-Analysis-of-Concentrating-Solar-Power-with-Thermal-Energy-Storage-in-a.pdf

The hyperlinks in this document were active as of April 2015.

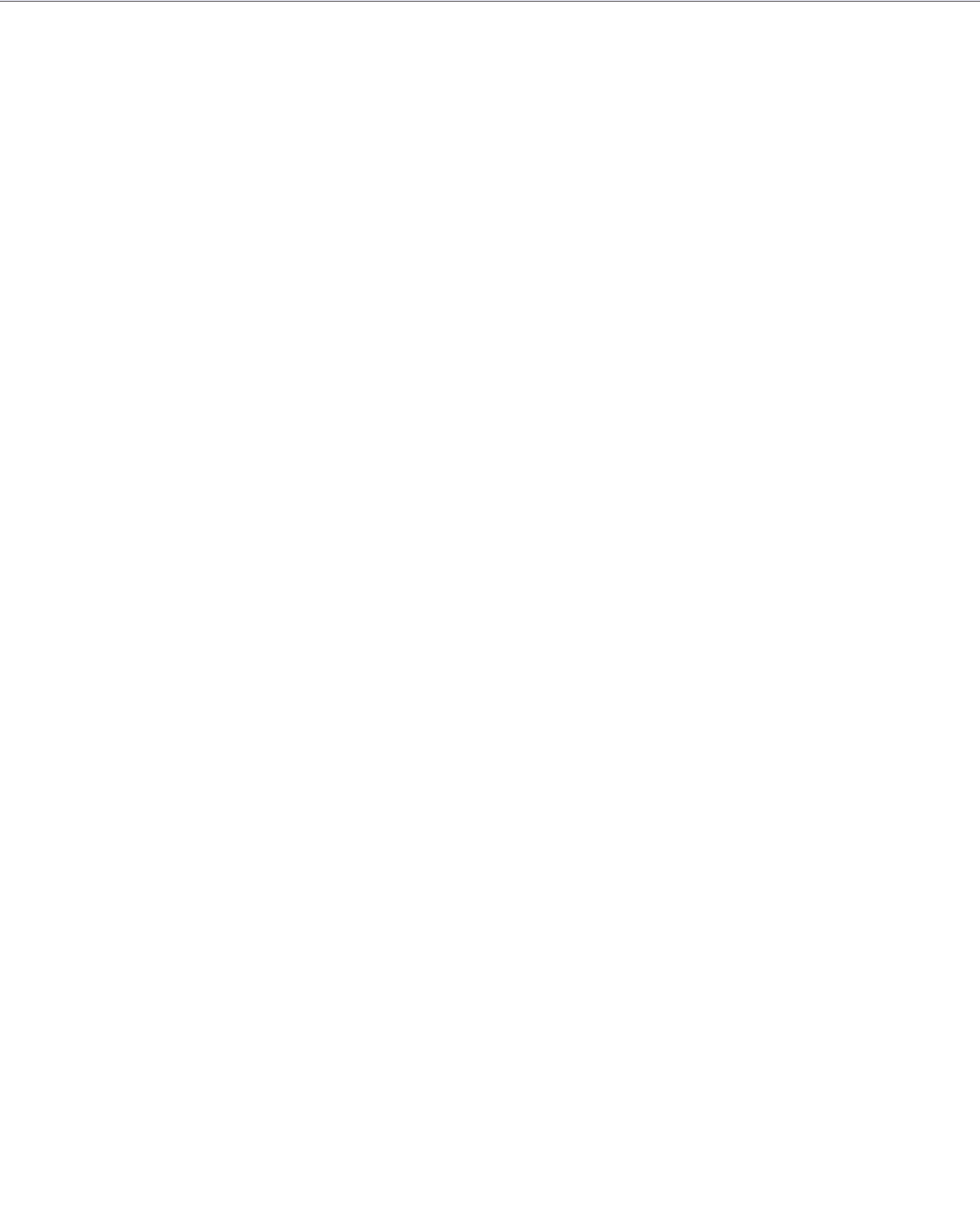

Section V – Public Policy

INTRODUCTION

Despite its relatively tiny scale at present, the solar industry has attracted a great deal of attention from all levels of government in the United States as well as from many foreign governments. Various policies to support the deployment of solar and other renewable electricity generation technologies have been adopted in the European Union; at the federal, state, and municipal levels in the United States; and in at least 138 nations around the world. The U.S. government has provided federal funding for solar research, development, and demonstration (RD&D) since the 1970s. In the last two chapters of this report, we explore the role of public policy in advancing solar energy technology. Specifically, Chapter 9 analyzes policies that create demand for solar technologies, so-called market pull approaches such as renewable portfolio standards. Chapter 10 considers policies that aim to improve solar generating options, so-called technology push approaches — it focuses on federal investment in solar RD&D. Both chapters are shaped by our broader view, articulated in Chapter 1, that human-caused climate change is a profoundly important problem, that it is accordingly vital that global carbon dioxide (CO₂) emissions be substantially reduced, and that greatly increased reliance on solar energy for electricity generation can play a critical role in reducing global emissions if (and most likely only if) the costs of solar electricity can be substantially reduced relative to the costs of other electricity generation technologies. In other words, what is required is that solar generation become competitive with other generation technologies when deployed at large scale with much lower per-kilowatt-hour subsidies than are currently in force in the United States.

It follows from this view that the division of any given level of spending between “market pull” and “technology push” efforts should reflect expectations about the determinants of future costs. If, for instance, one expects that RD&D is unlikely to deliver significant technology breakthroughs and that future cost reductions will come primarily from efforts by manufacturers and installers, policies that focus on deployment become relatively more attractive. Alternatively, if one believes that RD&D on solar generation and complementary technologies could achieve dramatic reductions in the overall future cost of solar electricity, investment in RD&D becomes more attractive on the margin, relative to subsidizing deployment of currently available technologies. While most members of the MIT study team favor shifting some spending from deployment to RD&D, our analysis in Chapters 9 and 10 concentrates on how any given level of spending on deployment and on RD&D can be more efficient and effective.

Public policies to support solar energy, whether they focus on market pull or technology push, respond to two significant market failures. The first market failure has to do with the damages caused by CO₂ emissions. To reduce current as well as future emissions, we favor putting an explicit or implicit price on CO₂ emissions through a comprehensive cap-and-trade system, a tax on emissions, or (less desirably) regulatory mandates. But the United States has not yet adopted such a comprehensive policy, and under these circumstances subsidizing the deployment of solar and other generation technologies with negligible CO₂ emissions might be part of a desirable

second-best emissions reduction policy. In addition, having some assurance that there will be a market for solar electricity will encourage private firms to engage in profit-seeking R&D aimed at reducing its cost and will contribute to the resolution of the institutional problems discussed in Chapter 4 and the integration problems discussed in Chapter 8.

Chapter 9 demonstrates, however, that the multitude of deployment subsidies that currently exists at the federal, state, and local levels in the United States adds up to an extremely inefficient policy regime: alternative regimes could substantially increase the value of solar electricity per dollar of subsidy. Chapter 9 argues that the fact that residential rooftop photovoltaics (PV) are subsidized at a far higher rate per kilowatt-hour of generation than utility-scale PV is particularly problematic.

The second market failure commonly cited to justify public investment in technology RD&D arises because private firms cannot capture all the benefits of these efforts (instead some of these benefits “spill over” to competing firms and society as a whole). As a consequence, the private sector does not invest enough in advancing technology. The case for government RD&D support is strongest when technologies are at the basic, pre-commercial level, since this is the stage at which private firms are least able to capture the benefits of success. Governments do not have a good track record of carrying out the development activities necessary to translate advances in basic science and technology into commercially viable products, and private firms can capture a larger share of the total returns to society of investments in developing better products or manufacturing processes once a technology has passed beyond the early R&D stages.

While these arguments apply broadly, advances in solar technology are particularly attractive to society because, as discussed in Chapter 1, solar energy has the potential to meet a large fraction of global electricity demand with virtually no CO₂ emissions. We argue in Chapter 10 that U.S. policy with respect to public RD&D investment should take a longer view than at present and aim to produce substantial advances in the performance of concentrated solar power (CSP) technologies as well as new, lower-cost PV technologies. Incremental reductions in the cost of today’s technologies may not make it politically possible to increase solar deployment enough to enable a substantial reduction in global CO₂ emissions.

Chapter 9 – Subsidizing Solar Technology Deployment

As noted at several points, we strongly favor a comprehensive policy to put a significant price on carbon dioxide (CO₂) emissions, either directly through a tax or indirectly through a cap-and-trade system. Such a regime provides an incentive to reduce CO₂ emissions from electricity generation and all other activities in the most cost-effective manner. Importantly, it provides across-the-board incentives for improving energy efficiency. In the presence of a cap on emissions, subsidies for the deployment of solar generation technologies would increase the cost of meeting the cap. In the presence of a carbon tax, such subsidies would reduce emissions but, by favoring one method of emissions reductions over others, would raise the cost per ton of emissions reductions. Deployment subsidies may nonetheless be justified even in the presence of a comprehensive carbon policy, however, if they contribute to advancing solar technology by producing knowledge that is widely shared. In contrast, subsidies to mature technologies, renewable and non-renewable, should be phased out once a comprehensive policy is in place.

In the absence of a comprehensive policy, subsidizing solar deployment may be justified as part of a second-best CO₂ reduction policy. In addition, ongoing deployment, even at

modest scale, is likely to help reduce institutional and other barriers to a rapid scale-up of solar generation in the future while also stimulating industrial efforts to reduce costs and improve performance.

In any case, neither the United States nor most other nations have put a significant price on CO₂ emissions. Instead, governments in many countries have adopted a variety of “market pull” policies to promote the deployment and use of solar generation technologies.¹ It is important to recognize, though, that solar technologies are not unique in this regard. The energy sectors in most nations are shaped by subsidies to multiple energy sources. In the United States, for instance, the U.S. Energy Information Administration (EIA) found that direct federal subsidies to solar energy in fiscal year 2010 were less than those to coal, natural gas and petroleum liquids, nuclear, and wind, and comparable to subsidies for biomass.³

In the absence of a comprehensive policy, subsidizing solar deployment may be justified as part of a second-best CO₂ reduction policy.

¹A detailed discussion and evaluation of alternative technology-specific policy approaches is available in Batlle, Pérez-Arriaga, and Zambrano-Barragán.¹ For an analysis that considers the impacts of alternative policies on choices among renewable technologies, with implications for CO₂ emissions, see Fell, Linn, and Munnings.²

While they differ in many respects, most of these policies to promote solar deployment can be usefully grouped into four main types: *price-based*, *output-based*, *investment-based*, and *indirect*.ⁱⁱ In almost all cases, solar generation of electricity is either treated the same as other renewable generation technologies or, more commonly, is given more favorable treatment. Such policies may be part of a second-best strategy to reduce CO₂ emissions (except in the European Union, where CO₂ emissions are capped) and perhaps to reduce the costs of solar electricity,⁹ but they are often described as advancing other objectives as well. Section 9.1 discusses some of these additional objectives.

Our main concern here is with the efficiency of solar deployment subsidies, i.e., with the value of electricity produced per dollar of subsidy spending.

Our main concern here is with the efficiency of solar deployment subsidies, i.e., with the value of electricity produced per dollar of subsidy spending. Sections 9.2–9.5 discuss each of the four main types of renewables policies listed above. Section 9.6 then describes what is known and (mostly) not known about the effectiveness of these policies in the United States, and Section 9.7 provides our recommendations for making U.S. solar deployment subsidies more efficient. We believe there is significant room for improvement.

9.1 OBJECTIVES OF DEPLOYMENT SUPPORT

Some have argued that deployment of solar generating facilities should be subsidized in order to build a competitive solar manufacturing industry in the United States, thus

positioning domestic suppliers to take advantage of high expected growth in global demand. The main problem with this argument is that subsidizing purchases of some product in the United States or any other nation does not guarantee that local suppliers will meet that demand, since nations' World Trade Organization obligations greatly restrict their ability to protect domestic suppliers with tariffs or quotas.¹⁰ For example, as a consequence of generous subsidies, particularly in Germany, the European Union (EU) accounted for over 53% of new photovoltaic (PV) module installations in 2012, but European firms accounted for only 11% of global module production.¹¹ In the complex global PV supply chain, technological knowledge readily travels across national borders, and the design and manufacture of these tradable products tend to be performed in the most cost-effective locations.¹²

Moreover, this argument rests on the assumption that even though the U.S. solar industry would be competitive in global markets with adequate investment, capital markets will not provide the necessary funding. But it has proven possible to raise large amounts of money for risky, long-lived investments in a wide variety of sectors — including projects that produce and use fossil fuels as well as others involving new technologies. We are aware of no evidence indicating that solar or other renewable technologies suffer any *special* handicaps that relate to the capital markets. If the global solar market has great growth prospects, it will attract capital — though not necessarily from the United States or for investment in the United States.

ⁱⁱUnless otherwise stated, information about U.S. policies in this chapter has been drawn from the Database of State Incentives for Renewables & Efficiency (DSIRE), the standard reference for current U.S. federal, state, and local policies to support energy efficiency and renewable energy.⁴ Detailed information on all energy-related federal subsidies in fiscal year 2010 is from the U.S. Department of Energy's Energy Information Administration (EIA).⁵ Information on support policies in the 28 EU nations and five affiliated nations is from LEGAL.⁶ The standard reference for support policies globally is from the Renewable Energy Policy Network for the 21st Century (REN21), updated annually.⁷ While we focus on support of solar energy here, it is worth noting that other energy technologies are also subsidized. In fiscal 2010, for instance, solar energy received only 8.2% of U.S. federal subsidies and support for electricity production.⁸

To be clear, it may be desirable to subsidize some domestic manufacturing to aid the process of advancing solar technology. Manufacturing cost is a critical attribute of any new solar technology, and it is often hard to judge manufacturing cost without actually doing manufacturing. But, as we discuss further in Chapter 10, this argument calls for selective support of firms working with promising new technologies rather than broad support of solar manufacturing.

Finally, since global greenhouse gas emissions drive climate change, widespread international adoption of new non-emitting technologies has global benefits and generally benefits the United States as well. Like all trade barriers, impediments to the flow of intellectual property or restrictions on the trade of products in the solar value chain reduce global economic efficiency. In this case, such barriers can only raise the cost to the world as a whole of reducing CO₂ emissions via increased use of solar energy.

FINDING

Barriers to the diffusion of solar technology or to international trade in products in the solar value chain will make it more expensive to slow climate change by reducing global CO₂ emissions.

It is sometimes argued that solar and other renewable energy technologies should be supported by government subsidies because they create more desirable jobs in the domestic economy than alternative energy technologies. There are at least three problems with this position. First, we are unaware of any rigorous studies showing that renewable technologies — particularly solar and wind — in fact have higher labor content, properly measured, per unit of output than relevant alternatives. Second, the notion that labor-intensive technologies deserve special support ignores

the fact that labor-saving innovations have been major drivers of economic progress. The mechanization of agriculture destroyed many jobs, for instance, but it helped make large-scale industrialization possible. The main long-term effect of subsidizing labor-intensive technologies is to raise the cost of goods and services provided by the private sector. Finally, if the government were to seek to create jobs in the short term by subsidizing particular industries, it is not evident that choosing renewable energy, rather than, say, infrastructure construction or public education, would be the most cost-effective choice.

Some also believe that the strong public support expressed for solar energy justifies the use of public funds to promote its use even absent a market failure rationale. But it is easy for citizens to be in favor of government spending on renewably-generated programs when this spending is not linked to personal costs or to reductions in other programs they also support. Similarly, while people often respond positively to surveys asking if they are willing to pay non-trivial amounts for renewably-generated electricity, it is well known that the answers to hypothetical questions of this sort overstate real willingness to pay.¹³ Thus, even though “green power” was available to about half of U.S. electricity customers in 2012, voluntary purchases of green power accounted for only 1.3% of total U.S. electricity sales in that year, with green power sales to residential customers accounting for only 0.3%.¹⁴

Finally, adding more solar generation would certainly increase supply diversity in the U.S. electric power system, which is becoming increasingly dependent on natural gas. But adding almost any grid-scale, non-gas technology would also serve this objective, and adding wind, biomass, or nuclear capacity might do so at a lower cost.

9.2 PRICE-BASED POLICIES

Though the United States has not made much use of this policy instrument, many nations have supported solar generation via *feed-in tariffs*, which entitle favored generators to be compensated for electricity delivered to the grid at predetermined, above-market rates for a fixed period of time.ⁱⁱⁱ The cost of this subsidy is generally added to the retail cost of electricity. Within nations that employ such policies, differences in the regional penetration of renewable generation — reflecting, for example, differences in insolation — would lead to

facilities defined as “qualified” at prices equal to the utilities’ “long-run avoided costs.” Avoided costs were to be determined by state regulators who were sometimes overgenerous, notably in California.^{iv} This system was largely dismantled by the early 1990s, as generous feed-in tariffs became increasingly unworkable in the face of declining electricity prices.¹⁸

In 1991, Germany became the first country to adopt feed-in tariffs explicitly aimed at promoting solar and other renewable technologies; Denmark followed suit the next year. Feed-in tariffs have proven a very popular policy abroad, and in 2008, the EU concluded that “*well-adapted* feed-in tariff regimes are generally the most efficient and effective support schemes for promoting renewable energy.”^v Feed-in tariffs played a major role in boosting solar energy in Germany, Spain, and Italy — EU countries that have led recent growth in the global solar energy market. As of early 2013, 71 countries and 28 states or provinces employed feed-in tariffs, including 17 EU member states.²⁰ In contrast, this policy mechanism is not widely used in the United States.^{vi}

Since solar power is at present one of the more expensive renewable generation options in most regions, feed-in tariffs that apply equally to solar and other renewable technologies could be expected to do very little to encourage solar generation relative to other renewables. Most feed-in tariffs in Europe provide higher rates for more expensive renewable technologies, with an eye to equalizing expected profitability — in these cases, solar generation typically receives the highest rate.¹⁶ The

Though the United States has not made much use of this policy instrument, many nations have supported solar generation via feed-in tariffs.

differences in the cost of electricity. European feed-in tariff schemes generally include systems for equalizing their impacts on electricity prices among sub-national regions.¹⁶ Since the costs of renewable generation are uncertain, change over time, and vary from project to project, the quantitative response to any particular tariff level is uncertain. In recent years, several of these schemes have limited the risk of excessive response by either limiting total spending in any year or by reducing the tariff automatically when quantity milestones are passed.

The first generally recognized use of feed-in tariffs was in the United States, under the Public Utility Regulatory Policy Act of 1978 (PURPA). PURPA required vertically integrated electric utilities to purchase power from

ⁱⁱⁱFor a general discussion of feed-in tariffs and their interaction with output quotas see Cory, Couture, and Kreyzik.¹⁵

^{iv}For a useful general discussion of feed-in tariffs, see Lesser and Su.¹⁷

^vEmphasis in original source — Commission of the European Communities.¹⁹

^{vi}Rhode Island, California, and Washington have feed-in tariffs for certain small generators. See also Couture and Cory.²¹

German feed-in tariff has been both generous and tilted toward solar, with the result that Germany, not a particularly sunny nation, had 45% of EU solar capacity and 26% of world capacity in 2013.²²

One very important and desirable property of feed-in tariffs is that they preserve strong incentives for both investment efficiency and operating efficiency. With the price of output fixed, every dollar of investment cost reduction translates into a dollar of profit, and every additional kilowatt-hour (kWh) produced adds to profit.

From the investors' point of view, fixing the output price removes all risk associated with the supply and demand for electricity. This may be a large part of the reason for the popularity of feed-in tariffs and their potency per dollar of subsidy spending.^{vii} But the level of spending understates the true subsidy involved, since shifting risk from renewable generators to other parties in the market for electricity is also a subsidy, albeit one that is essentially invisible.^{viii}

An important risk associated with feed-in tariffs is that the quantity of electricity supplied in response to any given level of subsidy is uncertain. With some technologies this would not be a significant problem because it often takes years to build a new generating facility, a long time relative to the time required to change support policies or to adapt the grid to handle new power flows. But PV, particularly residential PV, can be deployed much more rapidly. In 2013, for instance, PV capacity in China nearly tripled, in Japan it more than doubled, and in the United Kingdom it increased by 83%.²⁴ Between 2011 and the end

of 2013, PV capacity in Hawaii increased by 283%, mainly through the installation of distributed PV. By the end of 2013 more than one in nine Hawaiian homes had rooftop solar installed.^{25,26} Under the German feed-in tariff regime, deployment targets have sometimes been substantially exceeded despite reductions in support over time. The sensible approach eventually adopted in Germany was to reduce the level of subsidy automatically when deployment targets were met.^{ix}

Feed-in tariff schemes generally guarantee the same revenue per kWh regardless of when that power is generated.

Finally, feed-in tariff schemes generally guarantee the same revenue per kWh regardless of when that power is generated. The wholesale spot price of electricity (or system marginal cost in a vertically integrated system in which a single firm controls generation, distribution, and retail sales) often varies dramatically depending on weather, time of day, and other factors. Feed-in tariffs that do not vary with the wholesale price therefore reduce the subsidy (the difference between the feed-in tariff and the market price) when electricity is most valuable, thus distorting incentives regarding the timing of production. Since solar generators that are in operation today have little or no control over the time-shape of their output, this may be a small effect for these technologies, though the timing of planned maintenance

An important risk associated with feed-in tariffs is that the quantity of electricity supplied in response to any given level of subsidy is uncertain.

^{vii}Of course, investors still bear the risks related to the performance of the facility involved.²¹

^{viii}For a simple model of such risk-shifting, see Schmalensee.²³

^{ix}On the German experience, see Weiss.²⁷

outages is generally under the control of the unit's operators.^x For new systems, however, subsidies that vary with the wholesale price will provide incentives to face PV panels west instead of south.^{xi} West-facing panels produce less total electric energy over time compared to south-facing panels, but they tend to produce more during the late afternoon, when demand and prices are higher. And such subsidies would affect both the amount of storage built into new concentrated solar power (CSP) plants and the operation of those plants.

The use of tax credits instead of direct payments reduces the impact of the subsidy per dollar of cost to the government.

Output subsidy mechanisms (also known as premium tariffs or feed-in premiums) differ from feed-in tariffs in that they provide renewable electricity generators a predetermined per-kWh subsidy in addition to whatever revenues they earn from the sale of electricity, rather than a predetermined total price (amount of revenue) per kWh. The subsidy may vary (positively or negatively) with the wholesale price. As with feed-in-tariffs, the cost of the subsidy is generally added to retail electric bills. As with feed-in tariffs generally, this approach does not guarantee a certain level of renewable energy production. It has been notably less popular in Europe than the feed-in tariff.²⁹

Beginning in 1993, with lapses and modifications in the intervening years, the U.S. government has provided corporate income tax credits for each kWh produced by certain renewable technologies. Solar-powered generating units were only eligible if placed in service during 2005. Some states, including Arizona and Florida, offer state tax credits for renewable generation.^{xii} As we note in Chapters 4 and 5, the use of tax credits instead of direct payments reduces the impact of the subsidy per dollar of cost to the government. The problem is that to take advantage of the tax credit, a firm must have income at least equal to the credit, or must find a partner that does, and incur the significant cost of tax equity financing to obtain some of the benefits. The need to ensure that the tax credit can be used adds a constraint to the project finance problem that reduces the per-dollar impact of this form of subsidy by half, according to one source.³⁰ That is, spending a certain number of dollars on cash subsidies for renewable generation would induce more renewable generation than a program of tax credits that costs the government the same number of dollars in lost revenue.

The main advantage of an output subsidy as compared to a flat feed-in tariff is that it provides better incentives for producing electricity when the electricity is most valuable.^{xiii} In addition, under an output

^xIt is worth noting that in the absence of a feed-in tariff, if a firm owns conventional dispatchable generation, the more solar generation it also owns, the greater the potential profit it can obtain (via higher revenues for solar generation) by restricting conventional generation to raise market prices. If solar generators receive a (fixed) feed-in tariff, this potential profit is eliminated, and thus so is the incentive to exercise market power by restricting output from conventional plants. On the other hand, this potential problem can also be mitigated, at least in principle, by limiting the market shares of conventional generators or by restricting large conventional generators' ownership of solar facilities.

^{xi}California recently adopted an explicit incentive for west-facing solar systems.²⁸

^{xii}All information in this paragraph is from the DSIRE website.⁴ As we note below, the federal subsidy for solar did not disappear in 2006: it became an investment tax credit.

^{xiii}The system in the Netherlands, in which the subsidy is proportional to the market price, is particularly effective in this regard.¹⁶ In contrast, the system in Spain reduces the premium when the market price is high, presumably on the grounds that a high market price provides sufficient incentive.³¹

subsidy, electricity-market risk is borne by subsidized generators as well as by other market participants, and spreading risk generally increases economic efficiency. While prospective investors in favored technologies would rather not bear risk, it is socially efficient to compensate them for doing so by increasing the subsidy.^{xiv}

FINDING:

Among price-based subsidies, direct payments to renewable generators are more efficient than tax credits, and output subsidies provide better incentives for producing power when it is most valuable than flat feed-in tariffs. Because PV can be deployed very rapidly, the deployment response to price-based subsidies may depart rapidly and substantially from expectations.

9.3 OUTPUT-BASED POLICIES

Outside the United States, output quotas for renewable energy are not as popular as feed-in tariffs. As of early 2013, such policies were in place in only 22 countries at the national level.²⁰ Output quotas outside the United States are usually implemented via “tradable green certificates.” Solar and other renewable generators sell power at the market price and then are able also to sell, in effect, a 1-megawatt-hour (MWh) green certificate for each MWh of electricity they have sold. Distribution utilities or others obliged to source at least a certain percentage of their electricity consumption from renewables can show that they have done so by purchasing an appropriate number of green certificates (often via long-term contracts that also involve purchasing power) and

surrendering these certificates to the authorities. In recent years, it has become more popular internationally to have a government agency procure renewable generating capacity centrally; by early 2013, 43 countries, not all of which had output quotas, were using some variant of such centralized procurement.^{xv}

Outside the United States, output quotas for renewable energy are not as popular as feed-in tariffs.

The trading feature assures that costs are minimized within the jurisdiction involved, as the cheapest allowable renewable technologies are used to produce green certificates. Since solar is generally one of the most expensive renewable technologies, output quota policies without an explicit tilt toward solar are unlikely to do much to encourage solar generation. It is also important to note that, just as the quantity of renewable generation supplied in response to a fixed feed-in tariff is uncertain, the price of tradable green certificates is also uncertain under a fixed output quota.

Since solar is generally one of the most expensive renewable technologies, output quota policies without an explicit tilt toward solar are unlikely to do much to encourage solar generation.

In the United States, output quotas are universally known as *renewable portfolio standards* (RPSs). Iowa enacted the first RPS in 1983, and such programs are now in force in 29 states and the District of Columbia.^{xvi} Many RPS programs treat renewable energy technologies differently. Illinois, for instance, requires that 75% of renewable generation come from wind.

^{xiv}A disadvantage is that at high levels of penetration, the market power issue raised in Footnote x above could be important.¹

^{xv}For a discussion of the use of auctions in South America, where they are the main support method, see Battle and Baroso.^{32,33}

^{xvi}For a general discussion of RPS programs, see Schmalensee.²³

As of September 2013, 17 of the 30 state-level RPS programs in the United States included provisions that explicitly favored solar power or distributed generation (which in recent years has been predominantly PV).³⁴ Several of these programs give extra credit for solar or distributed generation, while Texas gives double credit for non-wind renewable generation. The others have minimum solar requirements of various sorts.

for renewable generation varies widely among states, nationwide trading of RECs could be an important way of reducing the cost to the nation of meeting a given quantity goal for overall renewable electricity production.

At present, however, only 16 of the 30 U.S. RPS programs permit the use of RECs from facilities that do not deliver to in-state customers to satisfy RPS requirements, and only two programs appear to accept RECs from renewable sources anywhere in the United States.^{xviii} Restrictions on trading appear in most cases to be motivated by a desire to promote local economic development. While a national RPS program could, in principle, reduce overall national costs, a national renewable portfolio requirement has never been enacted in the United States, and most proposals for such a policy contemplate leaving the states free to enact more stringent standards.^{xix}

It is not obvious why the output quota or RPS approach is so popular in the United States when experience internationally has made it so unpopular elsewhere.^{xx} One possibly relevant factor is that the costs of RPS programs are generally built into long-term contracts between utilities and generators and thus are much less visible than the explicit subsidies paid under feed-in-tariff or output subsidy schemes. There is certainly no general economic reason to favor a quantity-oriented

It is not obvious why the output quota or RPS approach is so popular in the United States when experience internationally has made it so unpopular elsewhere.

RPS obligations generally fall on entities that sell electricity to end users. In almost all cases, compliance is demonstrated by retiring “renewable energy certificates” (RECs) that function like the “tradable green certificates” discussed just above.^{xvii} Many RECs are sold as a bundle with electricity in long-term deals, so spot markets for RECs are generally thin, with few transactions and large spreads between the price bid and the price asked. In states with explicit requirements for solar generation, the requirement is generally met by retiring solar RECs, which are produced when electricity is generated by qualified solar facilities. Ideally, this trading mechanism would enable renewable electricity to be generated and used where it is relatively most efficient, with utilities elsewhere helping to bear the cost. And, since the potential

^{xvii}See, for instance, Cory and Swezey.³⁵ New York, Iowa, and Hawaii do not use RECs.

^{xviii}See Schmalensee.²³ It is also worth noting that only two RPS programs permit RECs to be banked for an unlimited period; most limit their lives to two or three years. It is not clear what purpose these limits are intended to serve.

^{xix}An additional output-based policy deserves mention. The U.S. military, the world’s largest energy consumer, has programs in place to meet a statutory mandate of 25% of total facility energy consumption from renewable sources by 2025.³⁶ While this is ambitious on several levels, the military plans to install only 1.1 gigawatts (GW) of PV capacity between 2012 and 2017, about one-third as much capacity as was installed in the United States in 2012 alone.³⁷

^{xx}For an examination of the effectiveness of U.S. RPS programs, see Carley.³⁸

approach like RPS over the price-oriented approaches generally used internationally; moreover, the quantity approach does not appear to be administratively simpler. Indeed, it is hard to imagine a more complex regime than the multiplicity of different state programs now in place in the United States.

FINDING:

A nationwide RPS program that permitted unlimited interstate trading would have lower costs for any given level of deployment of solar or other renewable generation than the multiple, diverse state programs now in place.

9.4 INVESTMENT-BASED POLICIES

The promotional mechanisms discussed so far all directly reward the production of electricity using solar energy. Policies that reward production are generally superior in terms of return per dollar spent to policies that subsidize investment in solar generation. They provide stronger incentives to reduce investment cost, to locate in areas with high insolation, and to maintain and operate generating units efficiently. With an investment subsidy, a dollar of investment cost overrun reduces enterprise profit by less than a dollar because it also increases the government's subsidy. Moreover, incentives to produce power are less than when production is subsidized or required. Finally, when a facility is owned by its builder rather than purchased from a third party, the fair

market value must be estimated in order to compute the subsidy. As discussed in Chapter 4, that estimation is subject to all the difficulties that arise in transfer pricing disputes in tax matters.^{xxi}

Policies that reward production are generally superior in terms of return per dollar spent to policies that subsidize investment in solar generation.

Nonetheless, at least 25 of the 30 countries that are part of the Organization for Economic Co-operation and Development (OECD) have used one or more forms of investment subsidy, generally along with other incentives or policies, to promote solar generation.⁴⁰ In some cases, these subsidies take the form of grants or other payments from the government, in which case they may be subject to budgetary pressure. In other cases, these subsidies are delivered as tax reductions, which restrict the investment to those entities that can take advantage of the reduction directly or, more commonly, by means of the tax equity market. In either case, the cost of the subsidy is borne by individuals in their roles as taxpayers rather than as electricity consumers. Electricity consumers generally bear the cost of price-based or output-based subsidies through higher retail electricity prices. Higher retail prices provide incentives to reduce electricity consumption across the board, thus further reducing fossil fuel use and CO₂ emissions. This incentive is absent when taxpayers bear the cost of investment subsidies.^{xxii}

^{xxi}A recent study estimates that prices reported for tax credit purposes for third-party-owned systems are inflated about 10% on average.³⁹

^{xxii}Fell et al., provide a quantitative analysis of this difference.²

Making REITs or MLPs available to solar developers would allow the government to replace the current investment tax credit entirely or in part and lower the cost of the subsidy to taxpayers without reducing its value to developers.

As discussed in Chapter 5, the U.S. federal government provides two significant investment-based subsidies for solar generation: five-year accelerated depreciation (since 1986) and a 30% investment tax credit (since 2006).^{xxiii} A number of observers have pointed to the stability of these policies as encouraging investment in the solar industry. In fiscal year 2010, the investment tax credit alone cost the federal government \$616 million.^{xxiv} Some solar industry stakeholders and supporters have argued that the federal government should increase investment subsidies by making solar generation projects eligible to be owned by real estate investment trusts (REITs) or, as is the case with pipelines and many other fossil energy projects, master limited partnerships (MLPs). These vehicles would essentially enable solar projects to avoid the corporate income tax and would also eliminate the need for most projects to go

through the tax equity market.^{xxv} Because of this latter feature, making REITs or MLPs available to solar developers would allow the government to replace the current investment tax credit entirely or in part and lower the cost of the subsidy to taxpayers without reducing its value to developers.^{xxvi}

In addition, all U.S. states now provide some subsidy for investments in solar electric generation. These incentives involve various mixtures of grants (direct or through local utilities), low-interest loan programs, reductions in state sales or income taxes, reductions in local property taxes, and tax credits of various sorts. In addition to a production tax credit, for instance, Arizona provides an investment tax credit, exempts solar generating equipment from the state sales tax, and exempts residential solar facilities from local property tax. Cities also provide a variety of investment-based subsidies. For instance, San Francisco and Chicago give cash grants for solar installations; Honolulu offers zero-interest loans; and New York City offers property tax reductions proportional to the costs of PV installations.

^{xxiii}Policies were and are in place to provide grants and subsidized financing for entities such as tribes and local governments that do not pay income tax.³⁷ Also, the American Recovery and Reinvestment Act of 2009, as amended, made it possible for business taxpayers to receive a grant instead of the investment tax credit for solar facilities begun before the end of 2012.⁴¹ By the end of October 2013, \$5.2 billion of such grants had been paid.⁴² The investment tax credit for residential facilities is scheduled to phase out at the end of 2016, when the credit for commercial facilities is scheduled to fall to 10%.

^{xxiv}The federal government has also guaranteed loans taken out to finance the construction of selected PV production facilities, thus providing investment subsidies for those facilities.⁴³ The EIA has estimated that in fiscal year 2010, federal loan guarantees for solar production facilities provided a subsidy of \$173 million.⁴⁴ Since the main aim of these loan guarantees seems to have been to advance technology, they are discussed in Chapter 10.

^{xxv}For a useful discussion, see Feldman and Settle.⁴⁵

^{xxvi}A related financing vehicle, the so-called yield co (YC) has recently become popular.⁴⁶ Classically, YCs own operating generating plants — solar and otherwise — that have sold their power under long-term contracts, and they pay most of the resulting cash flow directly to their shareholders. They thus produce bond-like returns for shareholders, but offer somewhat higher returns than can easily be obtained in the bond market. In addition, if most of a YC's plants are relatively new, depreciation will generally exceed revenue so that the YC will have no taxable earnings. In that case, payments to shareholders are treated as returns of capital and are accordingly not taxed at that level either. Thus, YCs can be a vehicle for deferring taxes for some years.

FINDING:

Investment-based subsidies, particularly those that take the form of reductions in profit taxes, are less effective per dollar of government cost at stimulating solar generation and displacing fossil fuels than price-based or output-based subsidies.

9.5 INDIRECT POLICIES

Beginning with Massachusetts and Wisconsin in 1982, 43 U.S. states plus the District of Columbia now subsidize the output from small, distributed renewable (including solar) generators by means of *net metering*; internationally, 43 other countries use this mechanism.^{xxvii} The federal Energy Policy Act of 2005 requires all utilities to make net metering available to those customers who request it. Net metering compensates these generators at the retail price for electricity they supply to the grid, not at the wholesale price received by grid-scale generators. A large fraction of the cost of running a distribution system is fixed, independent of load, but much or all of this fixed cost is generally recovered from retail customers through a per-kWh distribution charge. When a residential customer installs a rooftop PV generator, that customer's distribution charge payments are reduced. But there is no corresponding reduction in the distribution utility's distribution system costs. As noted in Chapter 7, the subsidy is the corresponding reduction in the utility's revenues, which may be made up by increasing the retail price paid by all customers.

For instance, in Boston in August 2014, the local distribution company, NSTAR, generally charged 9.8 ¢/kWh for electricity, reflecting average wholesale market prices, and 8.9 ¢/kWh to deliver that electricity. But electricity supplied by a rooftop PV array in Boston mainly saves NSTAR only its wholesale electricity cost; the delivery charge serves to cover NSTAR's costs to own and operate the distribution system.^{xxviii} Therefore, net metering in Massachusetts involves a substantial subsidy to distributed generation — as it does elsewhere.^{xxix} For at least some California retail customers, for instance, the value of the net metering subsidy apparently exceeds the value of the federal investment tax credit.⁴⁹

Moreover, because the distribution utility pays this subsidy, it has strong incentives to make it hard to install distributed generation. So-called decoupling arrangements in some states deal with this problem by automatically increasing per-kWh distribution charges so as to maintain utility profits. But this shifts the burden of covering distribution costs from utility shareholders to those customers who do not or cannot install distributed generation, a group that is likely to be less affluent than those who benefit from net metering.⁴⁹ Even at the current relatively low penetration of residential solar, this cost shifting has become controversial in many states. It seems unlikely that the much larger cost shifts that would be induced by substantial penetration of residential solar with net metering would generally be politically acceptable.

^{xxvii}Source is REN21, pp. 79, 80.⁷

^{xxviii}The installation of significant solar rooftop capacity will likely also require the utility to make incremental investments, as discussed in Chapter 7.

^{xxix}For a positive discussion of net metering, see Duke, et al.⁴⁷ For a recent quantitative analysis of its impact, see Satchwell, Mills, and Barbose.⁴⁸

In broad terms, the economically obvious solution is to move away from the prevalent design of distribution network charges that recovers fixed distribution costs via volumetric (per-kWh) charges.^{xxx}

Over the years, governments at all levels have employed policies that attempt to expand the use of renewable energy sources by means other than incentives or regulations.

As discussed in Chapter 7, the ideal approach would be to recover utilities' distribution costs through a system of charges that reflect each individual customer's contribution to those costs, not their kWh consumption. It is not yet clear how this ideal can best be approximated in practice, however.

FINDING:

By enabling those utility customers who install distributed solar generation to reduce their contribution to covering distribution costs, net metering provides an extra incentive to install distributed solar generation. Costs avoided by households that install distributed solar generation are shifted to utility shareholders and/or other customers. Recovering distribution costs through a system of network charges that is more reflective of cost causation and that avoids the current direct dependence on electricity consumption would remove the extra subsidy and prevent this cost shifting.

Over the years, governments at all levels have employed policies that attempt to expand the use of renewable energy sources by means other than incentives or regulations. These policies, which have been termed “enabling” or “catalyzing,” often involve education and information campaigns aimed more generally at building awareness and stimulating demand, as well as training programs designed to enhance supply.^{xxx} Efforts by municipalities in various regions to reduce balance-of-system costs for residential PV by, for example, simplifying and coordinating permitting, installation, and inspection; providing residential consumers with better price information; or adopting widely used standards would also fall in this category.^{xxxii} Policies that require grid operators to connect to renewable generators are also present in one form or another in 43 states and the District of Columbia and have likewise been characterized as catalyzing renewables deployment, though it may be more appropriate to consider them as simply offsetting distribution utilities' incentives to resist distributed generators for the reasons discussed above.

Since July 2009, grid operators in the EU have been required to “... give priority to generating installations using renewable energy sources insofar as the secure operation of the national electricity system permits...”⁵⁴ This policy aims to provide a less uncertain revenue stream to renewable installations and, perhaps more important, to force system operators and owners of conventional generators to develop operating rules that are compatible with large amounts of renewable generation. Since electricity generated from solar energy has zero

^{xxx}For a general discussion, see Kassakian and Schmalensee.⁵⁰ An alternative approach that has been discussed in some jurisdictions is to deploy two meters to value solar generation at the utility's avoided cost (which should correspond to the wholesale price) and to charge the consumer at the retail rate for all electricity consumed.⁴⁹

^{xxx}ⁱFor examples and a general discussion, see Lund.⁵¹ See also Taylor.⁵²

^{xxx}ⁱⁱFor a discussion of statewide efforts of this sort in Vermont, see North Carolina Solar Center.⁵³

marginal cost, this might seem consistent with economic (i.e., variable-cost-minimizing) dispatch of generating units. But in fact the EU policy constitutes an invisible, but potentially substantial, subsidy to solar (and other renewable) generation sources, and it increases system operating costs.

As discussed in Chapter 8, in areas with a large penetration of renewable generation, it is possible that at times of low electricity demand, some conventional thermal plants may be forced to shut down to allow renewable sources to be run at capacity. If that happens, energy must be expended (and thus costs incurred) to start the conventional plants up again, and these startup costs could well outweigh the variable cost savings from making greater use of renewable generators.^{xxxiii} There are also limits on the rate at which the output from thermal plants can be increased. In contrast, output from some renewable technologies, particularly PV and wind, can be varied without incurring additional costs. A requirement that renewable energy sources always have priority thus implies that costs associated with changing the output levels of conventional generating plants must be ignored in dispatch decisions.

It is unclear at the time of this writing how disruptive the EU's policy has been to European electric power systems or how large a subsidy it has provided to solar and other renewable generation technologies. Even after it resulted in a weeklong shutdown of a nuclear plant in Spain, fossil plant operators have not complained about the policy, probably because the extra costs of units that must stop and restart are generally reflected in wholesale prices. The

resulting higher prices are passed on to ultimate consumers and benefit all generators. To the best of our knowledge, no similar requirement exists anywhere outside the EU, although distributed PV generators are effectively given priority since they are not subject to control by grid operators.

9.6 POLICY EFFECTIVENESS IN THE UNITED STATES

As noted above, a wide variety of policies to support solar generation has been employed at the federal, state, and local levels in the United States. The costs of federal support policies, which operate through the federal tax system, are borne by all taxpayers, wherever they live. In contrast, the cost of net metering, RPS programs, and other state and local support policies are borne either by state or local taxpayers or by customers of affected electric distribution companies.

A requirement that renewable energy sources always have priority thus implies that costs associated with changing the output levels of conventional generating plants must be ignored in dispatch decisions.

Our discussion of these policies in the foregoing sections has been largely theoretical, and it would be extremely useful to supplement it with analysis of the actual effectiveness of these policies along several dimensions. At the very least, it would be useful to be able to compare generation per dollar of spending on various programs to support solar and other renewable energy technologies. It would be even better to compare the cost per ton of CO₂ emissions

^{xxxiii}Thermal generating units fueled by biomass may have marginal costs significantly above those of other thermal units. Giving priority to biomass units would then clearly increase system costs.

avoided via subsidies of various sorts to solar technologies with the per-ton costs of emissions reductions via subsidies to other renewable technologies, as well as the per-ton costs of other programs aimed at reducing greenhouse gas emissions.^{xxxiv}

Even if good estimates of emissions avoided were available, however, neither comparison would be possible. In the first place, there is no authoritative compilation of total spending to support the deployment of solar technologies — at the national level or for any particular state — let alone a breakdown of total spending across subsidy programs.^{xxxv} Even if these data were available, it would be essentially impossible to apportion credit for increasing renewable generation or reducing CO₂ emissions among the multiple support policies that are currently in place in the United States.

It would be essentially impossible to apportion credit for increasing renewable generation or reducing CO₂ emissions among the multiple support policies that are currently in place in the United States.

And, of course, states' deployment of solar or other renewable technologies depends on more than the support policies in force. California is the clear leader in U.S. PV deployment with 35% of the nation's capacity in 2012.^{xxxvi} Is that mainly because of California's aggressive RPS regime and many other renewable support policies or does it mainly reflect the fact that California is a large state with lots of sunshine in many places and very high marginal electricity rates? Arizona comes second with 20% of national capacity. It has an RPS policy that is

much less aggressive than California's, but it has a number of other support policies in place, and it also has a lot of sunshine. Finally, New Jersey is third with 7.4% of the nation's PV capacity. New Jersey is a small state without abundant sunshine that offers neither production nor investment tax credits, but it has had an RPS with a very strong solar requirement.

FINDING:

It is not known how much has been spent in the United States or in any individual state to support the deployment of solar generation. There is no empirical support for assessments of the cost effectiveness of individual support policies or of overall U.S. support for expanding solar generation or reducing CO₂ emissions.

In common with the policies of many other countries, **deployment support policies in the United States generally favor distributed, residential-scale PV generation over utility-scale PV generation.** As we noted above, net metering policies have this effect. Because the per-watt investment costs for residential PV are much higher than for utility-scale PV, the federal investment tax credit and accelerated depreciation contribute more per watt at the residential scale than at the utility scale. Both policies have the effect of lowering investment costs by a fraction, and because residential investment costs are larger per watt, so is the per-watt dollar subsidy implied by that fraction. Finally, some state RPS programs have a requirement for distributed generation and distributed generation is mainly solar PV.

^{xxxiv}For a recent attempt to measure the cost effectiveness of subsidies to wind power in Texas, see Cullen.⁵⁵

^{xxxv}It would thus be impossible to compare solar subsidies in the United States with those in China, even if we knew the level of subsidies in China, which, of course, we do not.

^{xxxvi}The state-specific numbers in this paragraph are from EIA.⁵⁶

If the objective of deployment support policies is to increase solar generation at least cost, favoring residential PV makes no sense. The results in Chapter 5 indicate that the per-kWh subsidy necessary to make residential PV competitive in central Massachusetts is 2.2 times the subsidy necessary to make utility-scale PV competitive.^{xxxvii} In California, this ratio is 2.9. With a \$40/tonne tax on CO₂ emissions, these ratios become 2.4 and 4.1, respectively. That is, any given total subsidy outlay borne by taxpayers and/or electricity consumers — if it is devoted to subsidizing residential-scale PV — will produce only a fraction of the solar electricity that would be produced if the same amount of subsidy were devoted to supporting utility-scale PV generation.^{xxxviii} Moreover, as Chapter 7 demonstrates, adding material amounts of distributed PV generation to existing distribution systems will require incremental investments to handle reverse power flows.

FINDING:

Subsidizing residential-scale solar generation more heavily than utility-scale solar generation, as the United States now does, will yield less solar generation (and thus less emissions reductions) per dollar of subsidy than if all forms of solar generation were equally subsidized.

If the objective of deployment support policies is to increase solar generation at least cost, favoring residential PV makes no sense.

9.7 CONCLUSIONS AND RECOMMENDATIONS

At least until the United States introduces a nationwide cap or tax on CO₂ emissions from fossil fuels, there is a case for promoting the use of solar and other renewable technologies that serve to displace fossil fuels. Such deployment is likely to provide additional benefits by reducing local air pollution, contributing to the advancement of solar technologies, and reducing institutional barriers to large-scale future solar deployment. The nature of the climate problem argues for minimizing the total cost of using solar and other generation technologies with negligible CO₂ emissions by any nation, which in turn argues against trying to restrict the flow of technological knowledge or the location of any of the operations in the solar value chain. Policies that aim to restrict the flow of knowledge are unlikely to succeed in any case.

At least until the United States introduces a nationwide cap or tax on CO₂ emissions from fossil fuels, there is a case for promoting the use of solar and other renewable technologies that serve to displace fossil fuels.

^{xxxvii}Table 5.1 shows base-case costs for central Massachusetts of 27.6 ¢/kWh for residential PV and 16.1 ¢/kWh for utility-scale PV. Comparing these figures with the 6.69 ¢/kWh cost for a natural gas combined cycle plant yields subsidy requirements of 20.91 ¢/kWh and 9.41 ¢/kWh, respectively. The ratio of the first of these to the second is 2.2. The other numbers in this paragraph are derived similarly, using the southern California base-case costs and then using 8.19 ¢/kWh as the natural gas combined cycle cost with a \$40/tonne carbon tax.

^{xxxviii}It is worth noting that, despite the high cost of subsidies necessary for residential PV to be competitive, the actual subsidies in force are sufficient to fuel continued rapid growth. Between the first half of 2012 and the first half of 2014, the installed capacity of residential PV in the United States more than doubled. However, even though the existing subsidy regime favors residential PV, the capacity of utility-sale PV quadrupled over the same period.⁵⁷

RECOMMENDATION:

Policies that attempt to restrict trade, investment, or knowledge transfers in solar technologies are generally undesirable since they make it harder to reduce global carbon dioxide emissions and advance solar technologies, and they are unlikely to yield sustainable national competitive advantage.

There is no obvious short-run environmental case for singling out solar energy for more aggressive deployment support than other renewable technologies; moreover, since solar tends to be more expensive than other renewable technologies (particularly onshore wind), there is a clear short-run economic cost. On the other hand, as we have noted at several points, the potential of solar power to be scaled up dramatically to meet global energy needs in a low-carbon future means that the long-run benefits of advancing solar technology and addressing the problems associated with dramatically increasing its use may exceed those of advancing other renewable technologies. And it seems plausible that ensuring a market for PV and concentrated solar power contributes to the advancement of those technologies. However, subsidizing the deployment of currently available solar technologies is

not likely, by itself, to improve U.S. competitiveness or achieve other goals that have been discussed in this context, particularly in the absence of barriers to the free flow of goods, ideas, and investment capital.

RECOMMENDATION:

Policies to support the deployment of solar technologies should be justified by their impact on global CO₂ emissions, on local air pollution, and, if appropriate, on the advancement of solar technology and the reduction of institutional and other barriers to substantially increasing its penetration.

This chapter's main message is that the current regime of U.S. policies for promoting solar-powered electricity generation is needlessly inefficient and delivers much less generation bang for the subsidy buck than obvious alternatives could produce. That regime, with its vast array of federal, state, and local subsidy and regulatory programs, many of which have hidden costs, stands in stark contrast to the simple and transparent support regimes used in many other nations. The United States can get much more solar generation per dollar of taxpayer and ratepayer expenditure by moving toward well-designed, national policies. In order to increase reliance on solar energy substantially at politically acceptable costs, it will likely be necessary both to reduce the cost of solar electricity through research, development, and demonstration (RD&D), as discussed in the next chapter, and, as discussed in this chapter, to increase the \$/kWh efficiency of solar deployment support policies. Output subsidies, feed-in tariffs, and renewable

The potential of solar power to be scaled up dramatically to meet global energy needs in a low-carbon future means that the long-run benefits of advancing solar technology and addressing the problems associated with dramatically increasing its use may exceed those of advancing other renewable technologies.

portfolio standards are all superior in principle to subsidizing investment via the tax system. Such subsidies are the federal government's main incentive device and are also widely used at the state and local levels. Using tax credits rather than direct expenditures reduces both transparency and generation per dollar of public expenditure. If tax credits must be used, the need for solar project developers to access the tax equity market should be reduced or eliminated, perhaps by making tax credits freely tradable.

RECOMMENDATION:

Subsidies for solar and other renewable technologies should reward generation, not investment, and should reward generation more when it is more valuable.^{xxxix} Tax credits should be replaced by direct grants, which are more transparent and more effective. If this is not possible, steps should be taken to avoid dependence on the tax equity market.

State RPS regimes generally do not reward generation more when it is more valuable. Even putting this serious problem aside, the current system of multiple, incompatible state RPSs with limited interstate trading needlessly inflates nationwide costs for any level of renewable generation attained. If an output quota approach like RPS is employed, it should be employed uniformly across the nation and phased out when a comprehensive carbon policy is in place and the subsidized technology is mature. If a nationwide RPS is not feasible, state programs should permit unlimited interstate trading to avoid forcing renewable generators to be built at undesirable locations.

RECOMMENDATION:

RPS programs should be replaced by subsidy regimes that reward generation more when it is more valuable. If that is not feasible, state RPS programs should be replaced by a uniform nationwide program. If a nationwide RPS is not feasible, state RPS programs should permit interstate trading to reduce costs per kWh generated and should adopt common standards for renewable generation to increase competition.

Finally, as we have discussed at several points, because residential PV generation is much more expensive than utility-scale PV generation, the subsidy cost per kWh of residential PV generation is substantially higher than the per-kWh subsidy cost of utility-scale PV generation. There is no compensating difference in benefits and thus there is simply no good reason to continue to provide more generous subsidies for residential-scale PV generation than for utility-scale PV generation.

RECOMMENDATION:

Residential PV generation should not continue to be more heavily subsidized than utility-scale PV generation. Eliminating this uneconomic disparity will require replacing per-kWh distribution charges with a system for recovering utilities' distribution costs that reflects network users' impacts on those costs.

^{xxxix}This assumes that the market power issue mentioned in Footnote x can be directly addressed by restrictions on the ownership of generation facilities.⁵⁸

Net metering with per-kWh charges to cover distribution cost is an important reason why residential PV generation is more heavily subsidized than utility-scale PV generation. In addition, net metering raises equity issues: it is far from obvious that it is fair for consumers with rooftop PV generators to shift the burden of covering fixed distribution costs to renters and others without such systems. Chapter 7 discusses the use of reference network models to allocate distribution costs among utility customers according to how their network usage profile contributes to those costs.⁵⁸

The discussion in Chapter 7 also notes the existence of a host of implementation issues, however, including the political acceptability of potentially very different charges for apparently similar network users. Because of the problems associated with net metering, research directed at developing a more efficient, practical, and politically acceptable system for covering fixed network costs should be a high priority.

While the current system of policies to support solar deployment in the United States is needlessly wasteful, it does not follow (and we do not believe) that such support should be ended. As noted at several points, we favor continued support of solar deployment in order to encourage industrial research and development and work on institutional and other barriers to greater reliance on solar energy and to produce environmental benefits. As the recommendations above make clear, however, we believe that the system of solar support policies should be reformed to increase its efficiency, so that more solar generation is produced per taxpayer and electricity-consumer dollar spent.

RECOMMENDATION:

Research should be undertaken to develop workable methods for using reference network models to design pricing systems that cover fixed network costs via charges that depart from simplistic proportionality to electricity consumption and that respect the principle of cost causality.

REFERENCES

- ¹Battle, C., I. J. Pérez-Arriaga, and P. Zambrano-Barragán. “Regulatory Design for RES-E Support Mechanisms: Learning Curves, Market Structure, and Burden-Sharing.” *Energy Policy* 41 (2012): 212-220. <http://www.sciencedirect.com/science/article/pii/S0301421511008238>
- ²Fell, H., J. Linn, and C. Munnings. *Designing Renewable Electricity Policies to Reduce Emissions*. Resources for the Future: Discussion Paper 12-54. (Dec. 2012). <http://www.rff.org/RFF/Documents/RFF-DP-12-54.pdf>
- ³*Direct Federal Financial Incentives and Subsidies in Energy in Fiscal 2010*. U.S. Energy Information Administration. (Aug 1, 2011). <http://www.eia.gov/analysis/requests/subsidy/>
- ⁴*DSIRE: Database of State Incentives for Renewables & Efficiency*. North Carolina State University. <http://www.dsireusa.org/>
- ⁵*Direct Federal Financial Interventions and Subsidies in Energy in Fiscal Year 2010*. U.S. Energy Information Administration. (Jul 2011). <http://www.eia.gov/analysis/requests/subsidy/pdf/subsidy.pdf>
- ⁶LEGAL Sources on Renewable Energy. <http://www.res-legal.eu/home>
- ⁷REN 21 Steering Committee. *Renewables 2014: Global Status Report*. (2014). <http://www.ren21.net/REN21Activities/GlobalStatusReport.aspx>
- ⁸*Direct Federal Financial Interventions and Subsidies in Energy in Fiscal Year 2010*. U.S. Energy Information Administration. (Jul 2011): Table ES4. <http://www.eia.gov/analysis/requests/subsidy/pdf/subsidy.pdf>
- ⁹Ellerman, A.D., F.J. Convery, and C. de Perthuis, *Pricing Carbon*. Cambridge University Press. (2010).
- ¹⁰http://tcc.export.gov/Trade_Agreements/Exporters_Guides/List_All_Guides/WTO_subsidies_AG_guide.asp
- ¹¹REN 21 Steering Committee. *Renewables 2013: Global Status Report*. (2013). 40,43 http://www.ren21.net/Portals/0/documents/Resources/GSR/2013/GSR2013_lowres.pdf
- ¹²Deutch, J. and E. Steinfeld. *A Duel in the Sun: The Solar Photovoltaics Technology Conflict between China and the United States*. A Report of the MIT Future of Solar Energy Study. (May 15, 2013). <http://mitei.mit.edu/system/files/201305-futureofsolar-SunDuel.pdf>
- ¹³Whitehead, J. C., and T. L. Cherry. “Willingness to Pay for a Green Energy Program: A Comparison of Ex-ante and Ex-post Hypothetical Bias Mitigation Approaches.” *Resource and Energy Economics* 29, no. 4 (2007): 247-261. <http://dx.doi.org/10.1016/j.reseneeco.2006.10.001>
- ¹⁴Heeter, J. and T. Nicholas, *Status and Trends in the U.S. Voluntary Green Power Market* (2012 Data). National Renewable Energy Laboratory. Technical Report NREL/TP-6A20-60210. (2013). <http://www.nrel.gov/docs/fy14osti/60210.pdf>
- ¹⁵Cory, K., T. Couture, and C. Kreycik. *Feed-in Tariff Policy: Design, Implementation, and RPS Policy Interactions*. National Renewable Energy Laboratory. Technical Report NREL/TP-6A2-45549 (Mar 2009). <http://www.nrel.gov/docs/fy09osti/45549.pdf>
- ¹⁶Klein, A., A. Held, M. Ragwitz, G. Resch, and T. Faber. “Evaluation of Different Feed-in Tariff Design Options.” Best Practice Paper for the International Feed-In Cooperation. 2nd edition, update by October. (2008). http://www.renewwisconsin.org/policy/ARTS/MISC%20Docs/best_practice_paper_2nd_edition_final.pdf
- ¹⁷Lesser, J. A., and X. Su. “Design of an Economically Efficient Feed-in Tariff Structure for Renewable Energy Development.” *Energy Policy* 36, no. 3 (2008): 981-990. <http://www.sciencedirect.com/science/article/pii/S0301421507004983>
- ¹⁸Ölz, S. “Annex 1: Renewable Energy Country Profiles”, in *Deploying Renewables: Principles for Effective Policies*, International Energy Agency (IEA) (2008). 330 <http://dx.doi.org/10.1787/9789264042216-2-en>
- ¹⁹Commission Staff Working Document. *The Support of Electricity from Renewable Sources*, Commission of the European Communities, SEC (2008) 57. (Jan 23, 2008): 3. http://ec.europa.eu/energy/climate_actions/doc/2008_res_working_document_en.pdf
- ²⁰REN 21 Steering Committee. *Renewables 2013: Global Status Report*. (2013): 68 http://www.ren21.net/Portals/0/documents/Resources/GSR/2013/GSR2013_lowres.pdf
- ²¹Couture, T., and K. S. Cory. *State Clean Energy Policies Analysis (SCEPA) Project: An Analysis of Renewable Energy Feed-in Tariffs in the United States*. Golden, CO: National Renewable Energy Laboratory, Technical Report NREL/TP-6A2-45551 (Jun 2009). <http://www.nrel.gov/docs/fy09osti/45551.pdf>

- ²²REN 21 Steering Committee. *Renewables 2014: Global Status Report*. (2014): 106. <http://www.ren21.net/REN21Activities/GlobalStatusReport.aspx>
- ²³Schmalensee, R. "Evaluating Policies to Increase Electricity Generation from Renewable Energy." *Review of Environmental Economics and Policy* 6, no. 1 (2012): 45-64. <http://reep.oxfordjournals.org/content/6/1/45.full.pdf+html>
- ²⁴REN 21 Steering Committee. *Renewables 2014: Global Status Report*. (2014): 111. <http://www.ren21.net/REN21Activities/GlobalStatusReport.aspx>
- ²⁵Hawaiian Electric Company, *Hawaiian Electric Power Supply Improvement Plan*. (Aug 2014): 3-3. http://files.hawaii.gov/puc/3_Dkt%202011-0206%202014-08-26%20HECO%20PSIP%20Report.pdf
- ²⁶Solar Energy Industries Association, *Hawaii Solar*. <http://www.seia.org/state-solar-policy/hawaii>
- ²⁷Weiss, J. *Solar Energy Support in Germany: A Closer Look*. The Brattle Group. (Jul 2014). <http://www.seia.org/sites/default/files/resources/1053germany-closer-look.pdf>
- ²⁸California Energy Commission, *California Moves to Improve Solar Incentive Program for New Homes*. Press Release. (Sep 3, 2014). http://www.energy.ca.gov/releases/2014_releases/2014-09-03_nshp_incentive_nr.html
- ²⁹<http://www.res-legal.eu/compare-support-schemes/>
- ³⁰*Issue Brief: Reassessing Renewable Energy Subsidies*. Bipartisan Policy Center. (Mar 25, 2011). http://bipartisanpolicy.org/sites/default/files/BPC_RE%20Issue%20Brief_3-22.pdf
- ³¹Agosti, L. and J. Padilla, "Chapter 15. Renewable Electricity Support: The Spanish Experience," in *Harnessing Renewable Energy in Electric Power Systems: Theory, Practice, Policy*. B. Moselle, et al, eds Washington: RFF Press. (Sep 8, 2010). <http://www.amazon.com/Harnessing-Renewable-Energy-Electric-Systems/dp/1933115904>
- ³²REN 21 Steering Committee. *Renewables 2013: Global Status Report*. (2013): 69 http://www.ren21.net/Portals/0/documents/Resources/GSR/2013/GSR2013_lowres.pdf
- ³³Battle, C. and L.A. Baroso. *Review of Support Schemes for Renewable Energy Sources in South America*, MIT Center for Energy and Environmental Policy Research, Working Paper 11-001 (2011). <http://web.mit.edu/ceepr/www/publications/workingpapers/2011-001.pdf>
- ³⁴*Modeling Distributed Generation in the Buildings Sectors*. U.S. Energy Information Agency. (Aug 29, 2013). <http://www.eia.gov/forecasts/aeo/nems/2013/buildings/>
- ³⁵Cory, K. S., and B. G. Swezey. *Renewable Portfolio Standards in the States: Balancing Goals and Implementation Strategies*. National Renewable Energy Laboratory, Technical Report NREL/TP-670-41409 (Dec 2007). <http://imap.statesadvancingwind.org/assets/Uploads/Resources-pre-8-16/NREL-RPS-goals-implementation-Dec07.pdf>
- ³⁶*Enlisting the Sun: Powering the U.S. Military with Solar Energy 2013*. Solar Energy Industries Association. (May 17, 2013). <http://www.seia.org/research-resources/enlisting-sun-powering-us-military-solar-energy-2013>
- ³⁷Sherwood, I. *U.S. Solar Market Trends 2012*. Interstate Renewable Energy Council. (Jul 2013). <http://www.irecusa.org/wp-content/uploads/2013/07/Solar-Report-Final-July-2013-1.pdf>
- ³⁸Carley, S. "State Renewable Energy Electricity Policies: An Empirical Evaluation of Effectiveness." *Energy Policy* 37, no. 8 (2009): 3071-3081. <http://www.sciencedirect.com/science/article/pii/S0301421509002250>
- ³⁹Pololefsky, M. *Tax Evasion and Subsidy Pass-Through under the Solar Investment Tax Credit*. Working Paper 13-05, Department of Economics, University of Colorado at Boulder. (Nov 2013). http://rintintin.colorado.edu/~sandt/ThirdpartyPV_paper_14.pdf
- ⁴⁰Brown A. and S. Müller, et al. *Deploying Renewables 2011*. *International Energy Agency*, 147, table 5.5. http://www.iea.org/publications/freepublications/publication/Deploying_Renewables2011.pdf
- ⁴¹*DSIRE: Database of State Incentives for Renewables & Efficiency*. Federal Incentives/Policies for Solar. <http://www.dsireusa.org/solar/incentives/index.cfm?state=us&re=1&EE=1&spv=1&st=1>
- ⁴²*Overview and Status Update of the §1603 Program*. U.S. Department of Treasury. (Dec 1, 2013). <http://www.treasury.gov/initiatives/recovery/Documents/STATUS%20OVERVIEW.pdf>
- ⁴³Energy.Gov Loan Program Office. <http://www.energy.gov/lpo/projects>
- ⁴⁴U.S. Energy Information Administration. *Direct Federal Financial Interventions and Subsidies in Energy in Fiscal Year 2010*. (July 2011). <http://www.eia.gov/analysis/requests/subsidy/pdf/subsidy.pdf>

- ⁴⁵Feldman, D. and E. Settle, *Master Limited Partnerships and Real Estate Investment Trusts: Opportunities and Potential Complications for Renewable Energy*, National Renewable Energy Laboratory, Technical Report NREL/TP-6A20-60413. (2013). <http://www.nrel.gov/docs/fy14osti/60413.pdf>
- ⁴⁶Martin, K. *Yield Cos Compared: Strategies, Benefits, And Drawbacks Of Yield Co Share Offerings*, Chadbourne & Parke LLP, (Dec 2013.) http://www.chadbourne.com/yield_cos_compared_12_13_projectfinance/
- ⁴⁷Duke, R., R. Williams and A. Payne. “Accelerating Residential PV Expansion: Demand Analysis for Competitive Electricity Markets.” *Energy Policy* 33, no. 15 (2005): 1912-1929. <http://dx.doi.org/10.1016/j.enpol.2004.03.005>
- ⁴⁸Stachwell, A., A. Mills, and G. Barbose, *Financial Impacts of Net-Metered PV on Utilities and Ratepayers: A Scoping Study of Two Prototypical U.S. Utilities*. Lawrence Berkeley National Laboratory. (Sep 2014). <http://eetd.lbl.gov/sites/all/files/lbnl-6913e.pdf>
- ⁴⁹*Net Energy Metering: Subsidy Issues and Regulatory Solutions*. The Edison Foundation, Institute for Electric Innovation. (Sep 2014). http://www.edisonfoundation.net/iei/Documents/IEI_NEM_Subsidy_Issues_FINAL.pdf
- ⁵⁰Kassakian, J. G., and R. Schmalensee. *The Future of the Electric Grid: An Interdisciplinary MIT Study*. Massachusetts Institute of Technology, (2011): 191-194. http://mitei.mit.edu/system/files/Electric_Grid_Full_Report.pdf
- ⁵¹Lund, P. D. “Effectiveness of Policy Measures in Transforming the Energy System.” *Energy Policy* 35, no. 1 (2007): 627-639. <http://dx.doi.org/10.1016/j.enpol.2006.01.008>
- ⁵²Taylor, M. “Beyond Technology-push and Demand-pull: Lessons from California’s Solar Policy.” *Energy Economics* 30, no. 6 (2008): 2829-2854. <http://dx.doi.org/10.1016/j.eneco.2008.06.004>
- ⁵³North Carolina Solar Center. *Vermont Public Service Board: Harmonizing Permitting and Interconnection Processes*. <http://solaroutreach.org/wp-content/uploads/2013/07/Harmonizing-Interconnection-and-Permitting-Processes.pdf>
- ⁵⁴EC European Commission. “Directive 2009/28/EC of the European Parliament and of the Council of 23 April 2009.” *Official Journal of the European Union* (2009). Article 16, Paragraph 2(c). <http://eur-lex.europa.eu/LexUriServ/LexUriServ.do?uri=Oj:L:2009:140:0016:0062:en:PDF>
- ⁵⁵Cullen, J. “Measuring the Environmental Benefits of Wind-generated Electricity.” *American Economic Journal: Economic Policy* 5, no. 4 (2013): 107-133. <http://pubs.aeaweb.org/doi/pdfplus/10.1257/pol.5.4.107>
- ⁵⁶U.S. Energy Information Agency, *State Electricity Profiles*. <http://www.eia.gov/electricity/state/>
- ⁵⁷Solar Energy Industry Association (SEIA). *New Report Shows U.S. Solar Industry Nearing 16 GW of Installed Capacity*, (Sep 4, 2014). <http://www.seia.org/news/new-report-shows-us-solar-industry-nearing-16-gw-installed-capacity>
- ⁵⁸Pérez-Arriaga, I., A. Bharatkumar. *A Framework for Efficient Distribution Network Charges: New Principles for New Problems*. MIT, Cambridge. Working paper (Forthcoming).

The hyperlinks in this document were active as of April 2015.

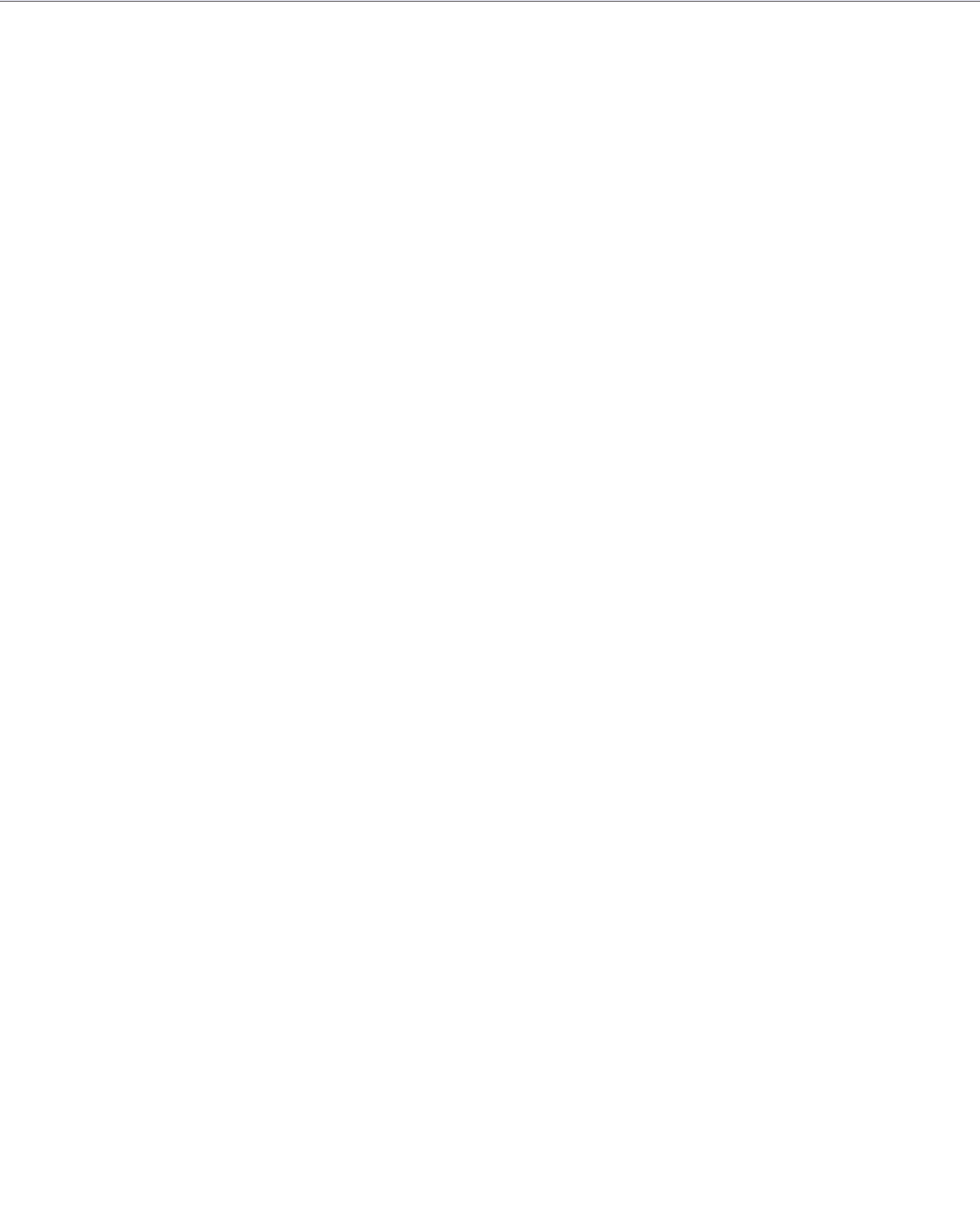

Chapter 10 – Advancing Solar Technologies: Research, Development, and Demonstration

10.1 INTRODUCTION

Preceding chapters of this report show that solar energy has the potential to play a significant role in meeting global electricity needs in a low-carbon future. However, beyond modest levels of penetration and absent substantial government support or a carbon policy that favors renewables, contemporary solar technologies remain too expensive for large-scale deployment. Therefore, to realize solar energy's sizable potential, large cost reductions are still needed. Several pathways to such reductions exist. In the case of solar photovoltaics (PV), progress in the short term will likely come from improving today's incumbent technologies — notably, solar cells based on crystalline silicon and a number of thin-film materials (see Chapter 2). Gains will flow from incremental increases in cell and module efficiencies, further scaling and streamlining of manufacturing processes, and innovations in installation hardware and practices. Over the longer term, much larger cost reductions may be achieved through the development of novel, inherently less costly PV technologies, some of which are now only in the research stage. Progress toward reducing the cost of concentrated solar power (CSP) technologies will likely follow a similar trajectory. In the near term, accumulating experience should enable today's designs to be built and operated at lower cost. Ultimately, however, more significant cost reductions will require the development of new materials and system designs that can meaningfully shift CSP's fundamental efficiency frontier.

The challenges that confront government efforts to stimulate technology change — whether on the supply side or on the demand side — are different and arguably greater in

To realize solar energy's sizable potential, large cost reductions are still needed.

commercial sectors such as energy, health, transportation, and agriculture than they are in sectors such as defense, space, homeland security, or intelligence where cost is not a central objective. These challenges include balancing competing objectives (e.g., low carbon emissions, environmental sustainability, energy independence, and job creation); dealing with a fickle legislature that does not always, or even usually, provide the stable funding that is so necessary for efficient technology development; and attracting and retaining public officials who understand private markets and for-profit investment decision-making. Finding an appropriate and effective balance in government efforts to support solar technologies is a difficult but crucially important task.

This chapter focuses on the broad issue of investment in solar energy research, development, and demonstration (RD&D) with a particular emphasis on identifying needs and promising approaches, and on the role of the U.S. federal government as a partner to industry and academia in pursuing them. After briefly reviewing the history of U.S. government support for solar RD&D, we discuss current

U.S. Department of Energy (DOE) solar RD&D funding objectives, and identify areas where we believe DOE should focus future PV and CSP RD&D activity. Concluding sections discuss DOE efforts to support solar demonstration projects and future opportunities for the Department to leverage its infrastructure to amplify the impact of its solar programs.

Finding an appropriate and effective balance in government efforts to support solar technologies is a difficult but crucially important task.

10.2 HISTORY OF U.S. GOVERNMENT SUPPORT FOR SOLAR RD&D

The federal government has a long history of supporting solar RD&D activity. Today, most

of this support is managed through the Solar Energy Technology Office (SETO) within DOE's Office of Energy Efficiency and Renewable Energy (EERE). Since the early 1970s, DOE has invested more than \$7.9 billion in solar energy, most recently through SETO/EERE-supported programs. Figure 10.1 shows the breakdown of this investment between PV and CSP technologies. Cumulatively, the PV and CSP programs have received approximately \$5.0 billion and \$2.9 billion respectively since the early 1970s.^{1,2} DOE also supports research relevant to PV and CSP technology development outside of EERE, with funding through its Office of Science and the Advanced Research Projects Agency–Energy (ARPA–E). Data on these expenditures, which are often targeted to individual projects rather than at the program level, are not included in Figure 10.1.

Figure 10.1 U.S. Department of Energy Support for Solar Technology Research (1974–2016)

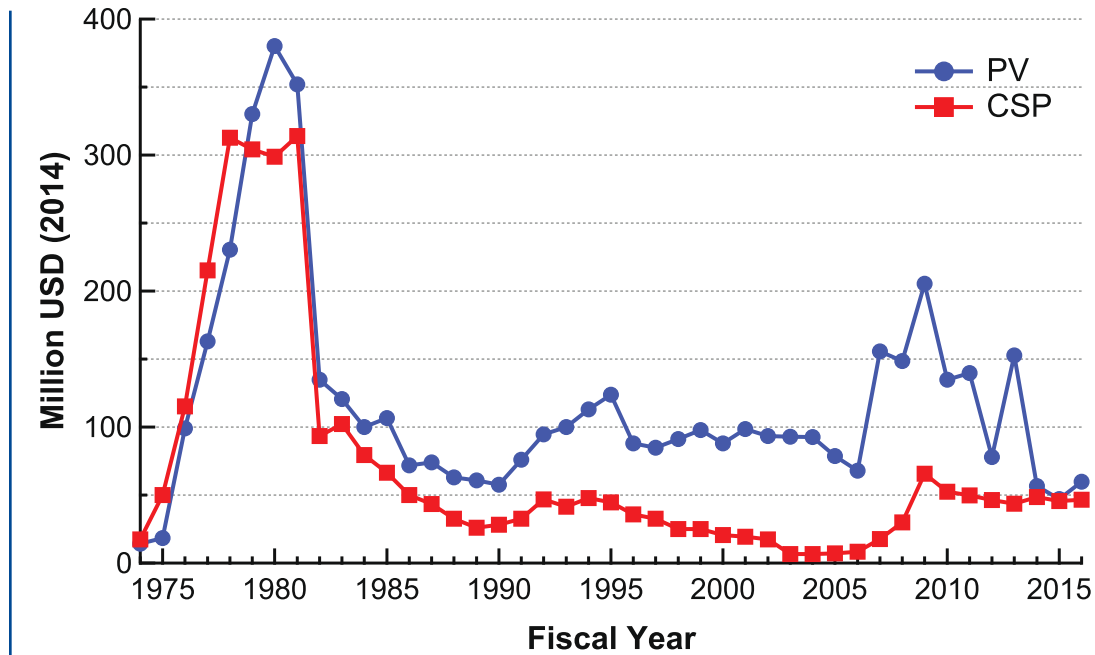

Note: Data do not include Office of Science funding for basic research relevant to PV and CSP.³

¹Figures include DOE's budget request for 2016 and 2009 appropriations under the American Recovery and Reinvestment Act of 2009.

As Figure 10.1 shows, DOE began providing significant funding for PV and CSP technology research during the late 1970s in response to the first oil crisis. Funding declined along with oil prices during the early 1980s and rose modestly throughout the early 1990s. Funding increased more substantially in 2007 and reached a peak in 2009, when additional spending on energy R&D was authorized as part of a broader effort to stimulate the U.S. economy under the American Recovery and Reinvestment Act of 2009.

Total DOE funding for solar energy research has fluctuated from year to year, often significantly. A number of factors are responsible for this variation, including changes in global energy prices, the state of the economy, changes in renewable energy policy, and decisions regarding overall federal research priorities.

Nevertheless, it is important to appreciate that large year-to-year budget swings have made it very difficult for research institutions to assemble and retain the talent necessary to execute the long-term basic research programs needed to develop breakthrough solar technologies.

Total DOE funding for solar energy research has fluctuated from year to year, often significantly.

RECOMMENDATION

DOE should avoid significant short-term fluctuations in solar RD&D funding to allow universities and national laboratories to recruit and retain the talent needed to support long-term research programs.

BOX 10.1 THE TENSION BETWEEN PROTECTING INTELLECTUAL PROPERTY AND DISTRIBUTING KNOW-HOW

Government support for RD&D compensates for the private sector's tendency to under-invest in promising technologies whose commercial value is viewed as too uncertain to warrant development by private firms. The guiding principle is that public support is justified because the public will benefit in the long term from investing in a portfolio of such technologies.

The universities and not-for-profit laboratories that generally perform government-funded early-stage research have long been allowed to claim patents, including some patents of great value, that spring from their work.⁴ This policy is justified by the notion that it provides an economic incentive for researchers or, more commonly, for their licensees to make the substantial investments necessary to commercialize results from early-stage research.

For later-stage RD&D activities, which inherently carry much lower technology risk and have

explicit commercial objectives, the situation is more complicated. When government supports late-stage RD&D, it frequently expects significant industry cost sharing. Understandably, the private firms that participate in such cost-sharing arrangements expect — and typically receive — intellectual property rights in return. These firms may therefore gain the opportunity to benefit commercially from early-stage public R&D investments at little or no cost, while non-participating firms — and by extension the general public — lose that opportunity. Public concerns about such arrangements are justified, especially when foreign firms are among the beneficiaries.

This tension, between granting intellectual property rights as a way to provide incentives for private firms' participation and disseminating the benefits of public technology investments as broadly as possible, affects all government "technology push" programs that seek to encourage late-stage RD&D. DOE's solar programs are not exceptions.

Since 2010, important changes have occurred in DOE's budget for solar RD&D. Figure 10.2 shows that the proportion of SETO's budget dedicated to solar system integration, balance-of-system (BOS) cost reductions, and solar manufacturing innovation and competitiveness

solar technologies cost-competitive with other forms of electricity generation by 2020.ⁱⁱ

Recent changes in SETO's funding priorities have been prompted by significant reductions in PV module costs over the past several years. As discussed in Chapter 4 of this report, today's modules cost between \$0.60 and \$0.70 per peak watt (W_p), meaning that current PV technology is already approaching the Sunshot Initiative's \$0.50–\$0.55 per- W_p cost target for 2020.⁵ Given this progress, SETO has progressively refocused investment away from PV technology programs and toward reducing BOS “soft costs” (i.e., non-hardware BOS costs associated with installing and connecting PV systems), while also fostering innovation in manufacturing competitiveness. The remaining SETO budget for PV R&D is spread across a variety of established cell

Since 2010, important changes have occurred in DOE's budget for solar RD&D.

has been increasing. From a comparison of SETO budgets for 2015 and 2010, it is apparent that the proportion of the overall budget that is dedicated to core PV and CSP technology programs has fallen from 80% to 33%. This shift in funding priorities has coincided with the launch of DOE's SunShot Initiative, a collaborative, national-level effort to make

Figure 10.2 Budget Breakdown for DOE's Solar Energy Technologies Office

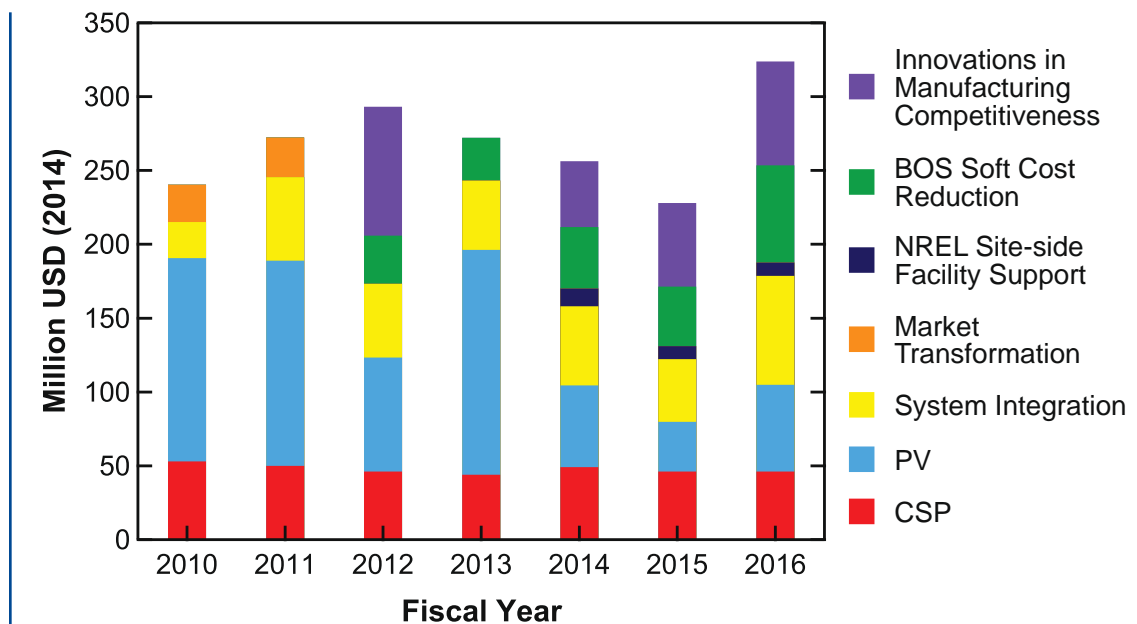

Note: Budget figures are in constant 2014 dollars.⁶ Figures are as enacted in each year except 2016, for which only requested budget data exist. Large year-to-year changes in the allocation of funding within SETO may be a response to the fast-paced development and commercialization of solar technologies. The chart does not include approximately \$24 million in annual funding for the Fuels From Sunlight Energy Innovation Hub.

ⁱⁱ <http://energy.gov/eere/sunshot/sunshot-initiative>

technologies based on crystalline silicon (c-Si), thin-film amorphous silicon, and cadmium telluride (CdTe), as well as several others that have been under development for some time using copper indium gallium diselenide (CIGS) and copper tin zinc sulfur selenide (CZTSSe) in addition to multi-junction, dye-sensitized, and organic devices.

The small size of SETO’s PV Energy Systems budget, and the relative conventionality of the technologies it supports gives the impression that SETO has determined that the contemporary PV technology paradigm, based on a rigid glass-covered PV panel (probably made using c-Si technology) surrounded by a metal frame, provides a sufficient long-term basis for scaling up PV deployment. While our study group agrees strongly with the need to reduce BOS costs, we consider the SETO SunShot-focused

strategy of achieving a reduction on the necessary scale within the contemporary paradigm to be too conservative and unduly short term. New technologies that can provide

New technologies that can provide the foundation for a new paradigm and enable a step-change in PV system costs are needed.

the foundation for a new paradigm and enable a step-change in PV system costs are needed. A much larger part of the SETO budget should be directed to developing the promising ideas already at hand, and discovering others.

Figure 10.3 shows the distribution of SETO funding to different types of RD&D entities in 2013. In that year, about one-quarter of the total SETO budget supported university-based

Figure 10.3 Breakdown of SETO Funding by Type of Recipient for FY2013⁷

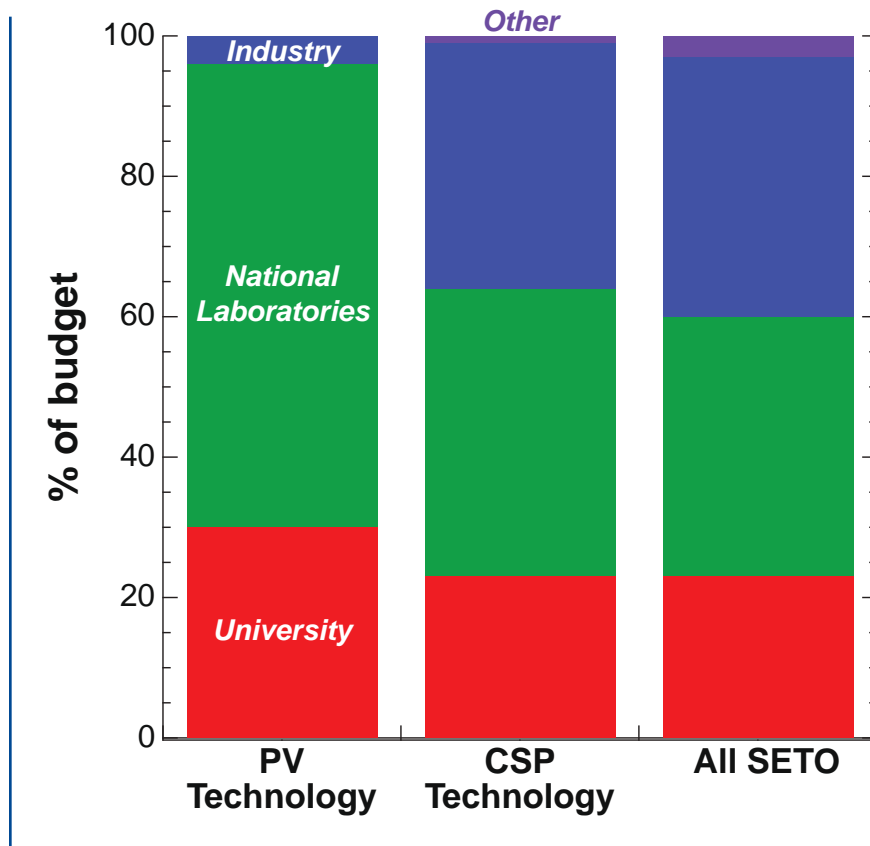

research, approximately 40% was directed to the national labs, and the rest was used to support industry-led RD&D. This funding distribution, with its heavy emphasis on applied research of nearer-term commercial relevance,

impact beyond what industry can deliver on its own, we suggest that scarce public resources should be largely redirected to support work on emerging high-potential, high-risk technologies that could fundamentally improve solar energy's competitiveness.

SETO, and by extension the federal government, is assuming a funding burden with respect to relatively mature technologies that firms should reasonably be expected to bear themselves.

reinforces the impression that SETO is underestimating the need for investment in fundamental technology. In its place, SETO — and by extension the federal government — is assuming a funding burden with respect to relatively mature technologies that firms should reasonably be expected to bear themselves so as to gain competitive advantage (see Box 10.1).

FINDING

In recent years, DOE has rebalanced the distribution of federal funding for solar RD&D, providing increased resources for areas where the industry should be motivated and well positioned to innovate, even absent public support.

Moreover, we note that advances in reducing BOS and integration costs, if they are closely tied to the contemporary technology paradigm, could quickly become irrelevant when a new paradigm emerges. Industry may have no option but to invest in such advances for near-term competitive reasons, but the case for government to do so is harder to make. DOE should therefore carefully assess and quantify the effectiveness of its support for RD&D efforts that target commercially relevant, nearer-term issues. Unless federal support has the potential to deliver a distinctive

RECOMMENDATION

DOE should focus its solar RD&D investments on supporting fundamental research to advance high-potential, high-risk technologies that industry is unlikely to pursue.

Without question, the success of increased RD&D investment cannot be guaranteed. Promising technology pathways based on novel thin-film materials, for example, are currently limited by relatively low conversion efficiencies and poor stability. Few have been demonstrated at the module scale. Nonetheless, if these or other as-yet-undiscovered pathways can be successfully pursued, they have the potential to dramatically improve PV competitiveness and thus to reduce the cost of moving to a low-carbon future.

Before going on to discuss future RD&D opportunities for PV and CSP, we note that DOE's 2016 budget request includes an increase in funding for SETO generally and a large increase in funding for PV research specifically. If Congress funds the DOE 2016 budget request, it would represent an appropriate and welcome reversal of the long-term trend toward less emphasis on transformative research.

10.4 DIRECTIONS FOR FUTURE RD&D

This section describes important areas for future government-supported RD&D for PV and CSP. In both cases, the motivation and objective must be to achieve dramatic reductions in overall system costs per unit of energy produced. For PV, we point to the likely need for a break with the contemporary rigid module paradigm. Enabling this will require new device and substrate materials, as well as efficient device and module designs with inherently lower cost, and greater flexibility of deployment. For CSP, we argue for a step-change in system efficiency based on operating at significantly higher temperatures, with a corresponding emphasis on point-focus, rather than conventional trough systems.

RD&D Opportunities in PV Technology

Materials and Cells

Creating improved PV technologies will require the contemporaneous development of new materials and device designs that can deliver optimized solar power conversion efficiency (PCE).

A number of properties and characteristics are desirable for materials used in PV devices (these concepts are described in more detail in Chapter 2 and Appendix B):

- **Optical and electrical properties**, including high theoretical efficiency based on strong optical absorption of the solar spectrum, and low carrier and transport losses.

- **Scalability**; specifically, high crustal abundance with scalable production pathways that are not constrained by the economics of byproduction (see discussion in Chapter 6) and that require few steps for synthesis.
- **Utility**, including stability under typical operating temperatures, illumination conditions, and environmental conditions (air/water exposure) over the more-than-25-year lifetime of a PV installation (concerns related to the toxicity of PV-active materials are elaborated in Box 10.2).

We believe high priority should be given to developing a new PV technology paradigm based on modules that use low-cost substrates and that are also light, mechanically robust, and self-supporting.

In particular, we believe high priority should be given to developing a new PV technology paradigm based on modules that use low-cost substrates and that are also light, mechanically robust, and self-supporting. These attributes would allow for a very different approach to managing BOS requirements, with lower hardware and “soft” costs than can be achieved with existing module technology. To dramatically reduce module costs, however, lightweight modules must be produced using scalable, high-throughput manufacturing methods, possibly involving deposition techniques such as inkjet printing, screen-printing, and spray coating. Continuous (sometimes known as “roll-to-roll”) deposition on thin-film substrates, or large-area batch processing techniques on light, rigid substrates may prove to be important in combination with these techniques.

BOX 10.2 MATERIAL TOXICITY CONSIDERATIONS FOR PV

Reduced use of toxic and environmentally hazardous elements such as cadmium and lead should be an area of focus for improved photovoltaics. Indeed, minimizing the release of such materials to the environment and managing their impact on natural cycles (particularly during mining, refining, manufacturing, and disposal) is an important consideration for any technology. When deployed at large scale, even the small quantities of toxic elements used in most types of PV modules developed to date may pose significant environmental hazards. For example, galena, the mineral from which the lead (Pb) used in lead sulfide (PbS) quantum dot (QD) solar cells is obtained, is stable under most conditions, and not a significant source of environmental Pb. However, when heated, as in a fire, PbS decomposes, forming several toxic and environmentally harmful substances.⁸ During the operational lifetime of a PV array, therefore, the encapsulation layers used to protect solar cells from environmental damage must also seal such hazardous materials inside the PV modules, even in a fire.⁹ In terms of human exposure to toxic materials, the greatest

safety risks are to workers at mining and PV manufacturing facilities who could be exposed to higher concentrations of these toxic elements during material extraction and preparation, cell and module handling, and waste management.

While risks related to the toxicity of PV-active materials could be managed through a combination of well-controlled encapsulation, monitoring, and recycling — as they are for lead-acid and nickel-cadmium batteries — we encourage continued investigation of non-toxic substitutes in early-stage technologies. A particular priority is finding substitutes for lead in perovskite and colloidal QD solar cells. Candidate materials should be evaluated throughout the full life cycle of a module, from mining to disposal and recycling. In addition, risk assessment and prevention procedures should be implemented for cases of module failure and to address the potential for subsequent releases of toxic elements to the environment. Finally, robust reclamation and recycling programs should be established to prevent these materials from being introduced into the environment at the end of the useful life of a PV module.

Crucially, RD&D efforts to develop a new, low-cost PV technology paradigm in a reasonably short span of time must be coordinated to ensure that successful materials and device designs can be rapidly advanced to the point of large-scale manufacturing.

RECOMMENDATION

DOE should coordinate RD&D efforts at all points along the development chain to provide for rapid manufacturing scale-up.

Inefficient PV technologies require a larger area and a greater number of modules to produce a given amount of power; in addition, many BOS

costs, such as those related to land acquisition and site preparation, scale with installation area. Therefore, system costs depend strongly on cell and module efficiency. Figure 10.4 illustrates this effect in the case of a contemporary, grid-connected, utility-scale c-Si PV system. Given typical module and BOS costs for such a system, two important features of Figure 10.4 stand out. First, at power conversion efficiencies below roughly 10%–15%, system cost (in dollars per W_p) falls rapidly with increasing module efficiency. Above this range, the marginal benefit of further efficiency improvements diminishes, as system cost is dominated by BOS components, such as inverters, that are independent of installation area. Increased power conversion efficiency is

Figure 10.4 Effect of Module Efficiency on the Cost of a Crystalline Silicon PV System

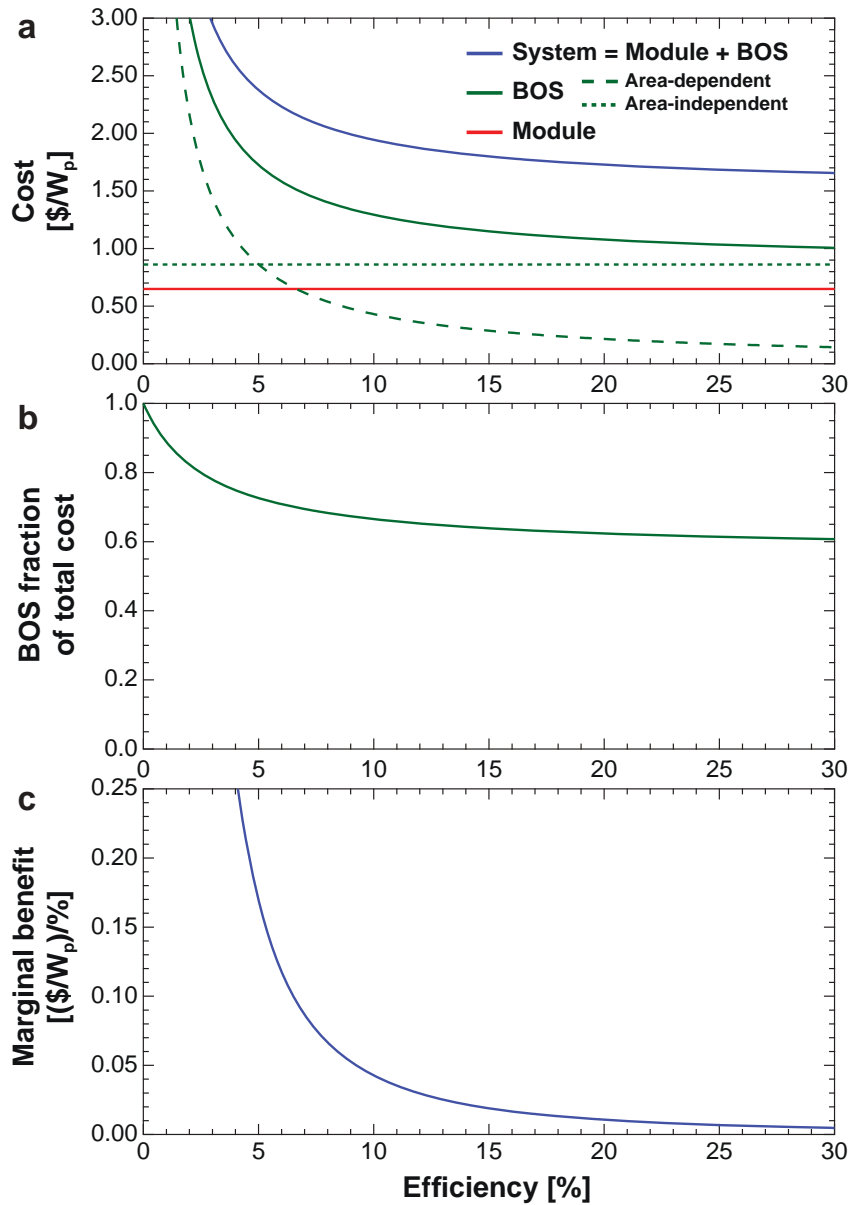

Note: Figure 10.4a shows the contribution of module and BOS costs to total system costs. BOS cost components can be divided into two categories: area-dependent (e.g., land, materials and labor for wiring and mounting) and area-independent (e.g., inverters, permitting, interconnection, and taxes). One-quarter of BOS costs at 15% power conversion efficiency (PCE) are assumed to scale with area, consistent with estimates for a contemporary fixed-tilt, utility-scale system.¹⁰ At 15% PCE, modules constitute 36% of the total system cost of \$1.80/W_p. A constant module price of \$0.65/W_p is assumed.¹¹ Figure 10.4b shows that higher module efficiencies reduce the importance of area-dependent costs and hence total BOS costs. At low efficiencies, the fraction of total system cost attributable to BOS costs approaches unity due to the larger system area required. In Figure 10.4c the marginal cost reduction from increasing PCE by a fixed quantity (e.g., one percentage point) decreases with increasing absolute efficiency.

therefore an important target for emerging, low-efficiency PV technologies, but assuming conditions typical of the southwestern United States (i.e., high insolation and low land costs) it becomes relatively unimportant above approximately 15%. Where land costs are high, efficiency remains important even at higher efficiencies, but the general conclusion still holds: efficiency gains above a certain level provide a low marginal cost reduction for a large PV installation. For a given BOS cost, what matters most is module cost per peak watt.

With very large manufacturing scale, module costs can be driven very low.

An important lesson from the recent sharp fall in c-Si module prices is that, with very large manufacturing scale, module costs can be driven very low. In a context where global demand for PV modules easily justifies investment in large factories, new technologies will compete with each other — at least in part — based on how rapidly their costs fall with increasing manufacturing scale. Likewise, as the scale of deployment needed to displace fossil generation leads to very large PV installations, module technologies will also compete on the basis of low area-dependent BOS costs. This should prompt efforts to develop substrate and device materials that are low-cost, compatible with large-area deposition techniques, and suited to rapid and inexpensive deployment in large installations.

RECOMMENDATION

DOE should fund RD&D for new PV materials and device architectures if they enable fundamentally lower-cost manufacturing and installation processes.

Modules

Much RD&D work on PV modules focuses on manufacturability. Reliably demonstrating module-level processes, however, often requires relatively large operational scale, which most university labs cannot achieve. National labs are well placed to support research on module integration and to oversee new pilot-scale manufacturing lines for emerging technologies.

Figure 10.5 highlights one key challenge of module integration — achieving module efficiencies that are close to the efficiency of individual cells. Record module efficiencies range from roughly 60% to 90% of cell efficiencies, and tend to be higher for older technologies. This long transition from efficient cell to efficient module accentuates the need for continued investment in module technology development.

RECOMMENDATION

Federal RD&D efforts should support pilot-scale demonstration of high-throughput processing techniques (e.g., roll-to-roll methods) for emerging thin-film PV cells and integrated modules.

BOX 10.3 THE PEROVSKITE STORY

The rapid emergence of hybrid organic-inorganic perovskites¹² as a promising thin-film PV technology is an example of a global RD&D success in the making.

The class of materials known as hybrid perovskites was first studied in the early 1990s. Basic materials characterization and device engineering showed high potential for use in light-emitting diodes (LEDs) and transistors, but PV applications were not explored. In the mid-2000s, perovskites were used for the first time in dye-sensitized solar cells (DSSCs) in place of typical organic dyes.¹² Employing a typical DSSC device structure and piggybacking on insights from that field, solid-state perovskite solar cells soon achieved promising efficiencies on the order of 10%. This development sparked a surge of interest in PV applications for perovskites, as researchers working on other emerging PV technologies applied their characterization techniques and processing methods to the perovskite material system. Record cell efficiencies for perovskite solar cells have increased to more than 20% since 2011 — an unprecedented rate of improvement.¹³

Despite these impressive developments, however, perovskites remain firmly in the early stages of RD&D. Key issues still remain in perovskite material and device development. For example, the use of toxic lead is a concern: further research is needed on the bioavailability and toxicity of lead specifically in perovskite materials, possible options for risk mitigation by encapsulation and recycling, and non-toxic substitutes (e.g., tin). Long-term stability and device lifetimes are unproven, and degradation mechanisms remain poorly understood. Improved stability could reduce encapsulation needs, allow more versatile module form factors, and lower module and BOS costs. In addition, more work is needed to demonstrate scalable and reliable processing of perovskite thin-film devices, and the myriad and inevitable challenges of module integration have yet to be resolved. Continued RD&D support may well determine whether perovskites or other emerging PV technologies realize their high potential and achieve cost-effective deployment within the next few decades.

Grid Integration and Energy Storage

As discussed in Chapter 8, integrating the intermittent output of PV installations into a system that reliably responds in real time to unpredictable fluctuations in electricity demand presents a very significant technological hurdle to utilizing solar power on a very large scale. For this reason, technologies that can help smooth the output of intermittent PV generators and make them operate more like dispatchable resources, and otherwise help ensure grid reliability at high levels of PV penetration, are important targets for federal RD&D. Economical bulk energy storage systems represent a key enabling technology for large-scale PV deployment, as they improve

Technologies that can help smooth the output of intermittent PV generators and make them operate more like dispatchable resources, and otherwise help ensure grid reliability at high levels of PV penetration, are important targets for federal RD&D.

the economic competitiveness of PV at high levels of penetration and mitigate the decline in value factors that would otherwise occur with increased penetration (for reasons discussed in Chapter 5) by enabling solar generators to shift their output away from hours of peak sunlight. We describe energy storage systems that are relevant for the electric power sector in Appendix C and solar-to-fuels technologies in an associated working paper.¹⁴

Figure 10.5 Effect of Development Time on Record Efficiencies of Solar Cells and Modules

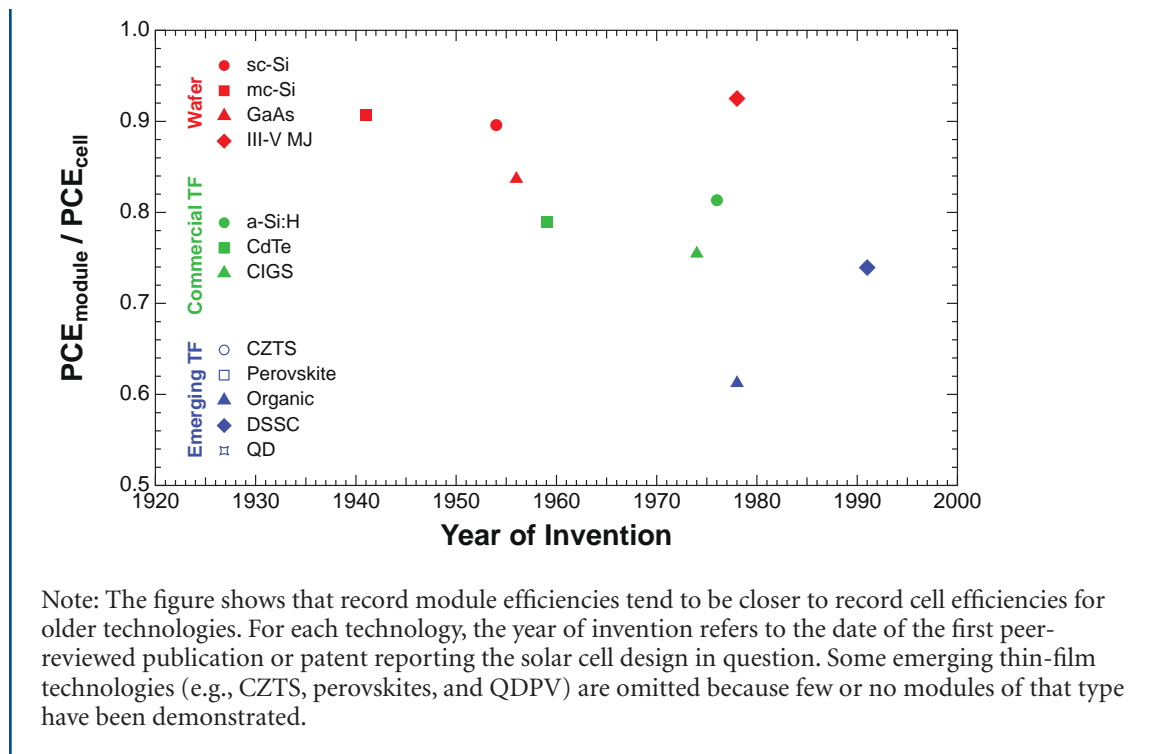

In part due to the availability of combustion turbines, demand management, and geographic averaging, current levels of PV penetration across the United States have not yet reached the point where the absence of large-scale storage capability is constraining further deployment.ⁱⁱⁱ Therefore, the appropriate balance of government support for storage technologies should emphasize fundamental research over deployment at the present time. Given the importance of energy storage for long-term, high-penetration deployment of

solar and other intermittent generation technologies, support for storage technologies within the DOE RD&D research portfolio should be a high priority.

RECOMMENDATION

Research on bulk energy storage should be strongly supported at a level commensurate with its importance as a key enabler of intermittent renewable energy technologies.

The appropriate balance of government support for storage technologies should emphasize fundamental research over deployment at the present time.

ⁱⁱⁱPumped hydro is a mature and efficient energy storage technology, but it is only applicable in specific geographic regions, most of which have already been exploited in developed nations.

Although we argue that SETO should rebalance its RD&D portfolio toward breakthrough cell and module technologies, and away from BOS generally, we recognize the need for federal support to advance BOS improvements in certain areas. In particular, innovative power electronics are needed to facilitate PV integration with the electricity grid at high levels of penetration. Further, efficient and reliable microinverters and techniques such as maximum power point tracking,^{iv} (which is so far widely used only in battery charge controllers and grid-connected inverters), could be introduced at the module level¹⁵ to increase power conversion efficiency for modules and arrays, and thereby improve PV economics at all scales. “Smart” inverters and electronics, particularly at the residential and commercial level, would also enable greater central control over the output of distributed, grid-connected PV generators and help grid operators maintain system stability at high levels of PV penetration while also, perhaps, reducing cycling costs for thermal plants (see discussion in Chapter 8). We note that many innovations in power electronics are not tied to contemporary system designs and may be equally applicable to many types of future PV systems. We are enthusiastic about DOE efforts in this field.

RECOMMENDATION

Government-supported RD&D to advance BOS technologies should continue to pursue innovations in power electronics that can improve system efficiency.

RD&D Opportunities in CSP Technology

Advances in CSP technology can be framed in terms of the interplay between RD&D on materials, system components, and system design. An important part of this interplay is the feedback from system design to the research agendas for CSP materials and components.

Priorities for the CSP RD&D agenda are informed by the costs and efficiencies of the major components of current systems. In Chapter 3 (Figure 3.2), we show the energy flow through a typical CSP plant^v to identify the major system inefficiencies. By far the two largest losses occur in the power block (40% efficiency) and the collector/receiver (42% efficiency). Together, losses at these two points account almost entirely for the overall 16% efficiency of the CSP plant. In a typical installation, the collector/receiver and power block are also the two most expensive components, accounting for 44% and 17% of total plant cost respectively. These cost and efficiency breakdowns suggest an RD&D focus on the collector/receiver and power block components in today’s CSP designs.

Of course, the relative efficiencies and costs of major CSP system components are sensitive to overall system design. For example, point-focus designs (such as solar towers) lend themselves to higher temperatures and thus more efficient and lower cost power blocks and thermal energy storage systems. The higher operating temperatures, in turn, lead to a set of new materials research problems.

^{iv}Maximum power point tracking (MPPT) is a feedback control technique whereby the power transferred from a source having output impedance to the input of a loading device is maximized by dynamically adjusting the voltage and/or current at the input of the loading device.

^vThese are simulation results for a 150-MW solar tower plant with 11 hours of storage located in Dagget, California. See Appendix D for details.

Finally, new materials can open the door to new system components and system designs. For example, the discovery of new thermal energy storage fluids or heat transfer fluids could enable the use of much more efficient power blocks, while also requiring new research on materials for use in other system components (e.g., pumps).

The major advantage of CSP as an electricity-generating technology is that it affords relatively simple and low-cost opportunities to integrate thermal energy storage, and can operate in hybrid configurations with other thermal processes.

As we point out in Chapter 3, the major advantage of CSP as an electricity-generating technology is that it affords relatively simple and low-cost opportunities to integrate thermal energy storage, and can operate in hybrid configurations with other thermal processes. As a result, CSP systems can be designed to provide dispatchable electricity and to

incorporate storage (or effective storage) ranging from minutes to days. RD&D to improve and exploit this unique capability should also be a priority.

Another attribute of CSP systems noted in Chapter 3 is that they are economic only when deployed on a large scale. Pilot-scale demonstrations can play an essential and cost-effective role in moving from laboratory research on materials and components to full systems. The need for pilot-scale demonstration facilities is discussed further in Section 10.5 and illustrated by the history of CSP RD&D (Box 10.4).

The next sections discuss RD&D opportunities and challenges for different aspects of CSP technology — specifically, high-efficiency solar energy collection and receiving systems (including novel CSP system configurations), efficient and cost-effective thermal energy storage systems, advanced high-temperature power cycles, and novel system designs for CSP integration and hybridization.

BOX 10.4 THE HISTORY OF CSP RD&D

DOE supports CSP as a unique technology that can deliver solar-generated electricity on demand through thermal energy storage (Chapter 3). Federal support for CSP in the United States dates back to DOE's formation in 1977. Two significant early projects, Solar One and Solar Two, involved pilot-scale demonstrations of tower technology.¹⁶ In 1981, DOE, Southern California Edison, the Los Angeles Department of Water and Power, and the California Energy Commission worked together to build Solar One, a 10-megawatt (MW), pilot-scale facility located in Barstow, California. Solar One demonstrated a tower configuration for steam generation of electricity using hot oil

circulating through the tower and thermal storage in rocks. It operated from 1982 through 1986. In 1995, DOE and a consortium of utilities led by Southern California Edison built Solar Two, which made use of some of Solar One's remaining infrastructure. This pilot-scale tower was designed to demonstrate the use of molten salts in the thermal energy receiver and for storage. Solar Two ran successfully between 1996 and 1999. Since CSP designs, unlike PV cannot be effectively tested at small scale, this sort of pilot-scale system demonstration is very important as a means to mitigate the risks of constructing a facility at the very large scale typical of utility generation plants being built today (see Chapter 3).

High-Efficiency Solar Energy Collection and Receiving Systems

As discussed previously, the most expensive and second least efficient component of a typical CSP plant is the collector/receiver, which gathers solar energy in the mirror field and converts it to thermal energy. Key RD&D priorities for the mirror field include lower cost manufacturing and installation, less costly and more accurate tracking systems, more efficient mirrors, and engineered surfaces to prevent fouling in desert environments — all improvements that would enable future plants to achieve tighter light focusing and higher temperatures. Basic research at universities on surface modification and thin films may lead to breakthroughs in the latter two areas, and applied research undertaken by universities, national laboratories, and industry researchers can lead to lighter-weight, easier-to-manufacture mirror designs. Most of the applied research to reduce mirror weight and manufacturing costs, however, will appropriately fall to industry as it scales up new CSP technologies.

As described in Chapter 3, a point-focus CSP architecture (e.g., solar tower) can generally achieve higher power conversion efficiencies than the older trough technology, since point-focus designs deliver a higher-temperature heat source to the power block. Based on this inherent efficiency advantage, we recommend that most future CSP research target point-focus technologies or new, novel configurations rather than incremental improvements to trough designs.

Although a higher-temperature heat source increases the heat-to-electricity conversion efficiency of CSP systems, it also creates material-related challenges. One such challenge is to develop suitable receiver materials and heat transfer fluids that are capable of handling high

Key RD&D priorities for the mirror field include lower cost manufacturing and installation, less costly and more accurate tracking systems, more efficient mirrors, and engineered surfaces to prevent fouling in desert environments.

temperatures without degrading and can also get through the night without freezing. Another challenge is to develop construction materials and designs for components such as pumps and pipes that are capable of withstanding exposure to high temperatures. These challenges point to important new directions for basic and applied research in this field.

RECOMMENDATION

Future CSP RD&D should emphasize high-temperature, point-focus technologies that hold promise for improving system efficiency and cost-effectiveness.

Efficient and Cost-Effective Thermal Energy Storage Systems

One of the unique characteristics of CSP technologies is that they offer easy and cost-effective opportunities to incorporate significant thermal energy storage. Many problems in thermal storage must be addressed, however, to exploit this synergy fully. Much recent research has focused on developing molten salt compositions suited to parabolic trough and point-focus applications. This work leverages extensive past research on molten salts for high-temperature nuclear reactors.¹⁷ Progress with molten salts has enabled operation at higher temperatures and provided for greater thermal energy storage density. However, problems with freezing at the low-temperature end of the process and thermal decomposition at the high-temperature end of the process may

require new thermal energy storage materials depending on the overall CSP configuration used. A particular issue here is to keep material costs low, since large quantities of storage material will be needed.

In addition, better understanding is needed of material properties at the high (greater than 500°C) temperatures contemplated in new CSP designs. Specific topics include the radiative heat transfer properties of molten salts, including absorption but also scattering and emission; chemical compatibility (corrosion, dissolution) of structural materials in high-temperature molten salts; and rugged and compact heat exchangers for operation with high-temperature molten salts. Basic research is also needed on other high-energy-density and long-term storage approaches, perhaps in the form of chemical energy and phase change materials.

RECOMMENDATION

New thermal energy storage materials and concepts should be developed and further explored in future CSP RD&D activities.

Advanced, High-Temperature Power Cycles

Power cycles that are both more efficient and cheaper (as well as smaller scale, if possible)^{vi} are needed. Advanced, high-temperature power cycles have the potential to produce electricity at higher efficiencies and lower cost than the traditional cycles used in fossil-fuel plants.

Since high-temperature power cycles are inherently more efficient, they might be economic at smaller scales than current Rankine-cycle systems. If high-temperature power cycles can be implemented cost-effectively at smaller scales, this would both reduce capital cost requirements and alleviate an existing difficulty in point-focus CSP plants with respect to the need to focus mirrors over long distances. Finally, alternative power cycles might reduce or eliminate the need for process (cooling) water, which is often in short supply in the typically arid regions that have the largest solar resource.

In FY2015, SETO's CSP subprogram began collaborating with DOE's Offices of Fossil Energy and Nuclear Energy and with EERE's Geothermal Technologies program on a crosscutting initiative through the Advanced Solar Power Cycles RD&D activity to advance supercritical carbon dioxide (CO₂) electricity production technology. Air and supercritical CO₂ Brayton cycles may offer significant advantages over today's power cycles; they are described in Chapter 3 of this report (Section 3.6).

RECOMMENDATION

DOE should continue to invest in RD&D on high-temperature power cycles that hold promise for significantly boosting the conversion efficiency and reducing the cost of CSP power plants.

^{vi}For a discussion of power cycles, see Box 3.1 and Section 3.6 in Chapter 3.

Novel CSP Design, Integration, and Hybrid Configurations

Research on novel CSP configurations can exploit the inherent advantages of CSP technology — namely, that it allows for the natural integration of energy storage and easy hybridization with fossil power plants — and may enable the efficiency limitations of current systems to be overcome. In particular, novel configurations can provide a platform for integrating innovations in the three research opportunity areas discussed previously (i.e., high-efficiency collection and receiving systems, efficient and cost-effective energy storage systems, and advanced power cycles). An example is the direct solar-to-salt design described in Chapter 3 (Section 3.6 and Figure 3.12), which — by combining the traditional elements of receiver and thermal energy storage container — simultaneously addresses several issues with respect to efficiency losses, materials design challenges, thermal storage, and operational temperature.

Finally, numerous research opportunities exist for exploiting the thermal energy collected in CSP plants to provide energy for thermochemistry and process heat. Because this study is focused on solar electricity generation, we do not discuss these applications in detail other than to note that by stopping short of the electricity production step, they eliminate power block losses altogether. An example is the use of steam produced by concentrated solar thermal plants for enhanced oil recovery. In such applications, the thermal energy collected by the solar plant can either supplement fossil energy sources or replace them. Concentrated solar thermal energy can also be used as a heat source for reforming, cracking, and gasification processes. With potential advances in the future, it might also be used for water splitting¹⁸ to produce hydrogen.^{vii}

There are a variety of ways in which the thermal energy collected by CSP plants might be exploited efficiently in thermochemical and other thermal processes. These processes and designs need to be considered for further development and possible commercialization as part of a broader CSP RD&D portfolio.

10.5 DEMONSTRATION SUPPORT FOR SOLAR TECHNOLOGIES

The federal government has long provided support for energy technology demonstration, including for early light water nuclear reactors, and more recently for efforts to demonstrate

The demonstration of new PV and CSP technologies at appropriate scale is a critical step in the progression to large-scale deployment.

carbon capture and sequestration. The demonstration of new PV and CSP technologies at appropriate scale is a critical step in the progression to large-scale deployment. Exactly what scale of demonstration project is necessary to build confidence in a technology and move it through the development cycle will vary. In the case of PV systems, where technical performance is largely insensitive to scale (*economic* performance, it should be noted, is sensitive to scale, even for PV systems), confidence can be gained even from very small-scale demonstrations. By contrast, the *technical* performance of CSP systems is inherently sensitive to scale and proving out these systems requires demonstration projects that are at least pilot-scale in size.

^{vii}Water splitting could be achieved through solar thermolysis or a solar thermochemical cycle.

Loan Guarantee Programs

Over the past several years, the loan guarantee programs administered by DOE's Loan Programs Office (LPO) have been held up as an important example of demonstration support for solar PV and CSP technology.^{19,20} Fourteen individual solar projects have received LPO support, all as part of the Section 1705 Loan Program. In total DOE has provided \$5.85 billion in loans for CSP projects (including \$5 billion as the sole lender) and \$4.74 billion in loans for PV projects (including \$3.28 billion as the sole lender). All of the CSP and PV loans are currently in good standing. DOE has also provided \$1.085 billion in loans for solar manufacturing; of this total, \$596 million is classified as discontinued (including \$528 million drawn by Solyndra Inc.), which indicates termination of the loan or guarantee, an ongoing bankruptcy proceeding, or (possibly pending) sale of the guaranteed note.²¹

A key objective of any technology demonstration program should be to develop insights regarding, among other things, the cost, technical performance, and reliability of new technologies when deployed at commercial scale. Sharing this information with the private sector should build confidence in the technologies being demonstrated and help reduce perceived technology risks to the point where private capital becomes available to support deployment. While DOE loan guarantees have certainly enabled the development of several very large (i.e., commercial-scale) PV and CSP installations, with combined capacity totaling

1,200 megawatts (MW), it is not clear that the current loan program has been effective in achieving desired technology demonstration objectives, particularly since DOE has not produced any comprehensive public reporting on the costs and performance of the technologies the program has supported.

FINDING

Many of the solar projects supported by DOE's loan guarantee programs to date are of a scale well beyond that needed for effective commercial demonstration; moreover, very high loan repayment rates suggest an overly conservative loan guarantee project portfolio.

The fact that only 2.2% of DOE's PV and CSP generation loan book is now in default indicates that the risk profile of projects supported by the federal loan program has been very conservative. Furthermore, several projects that have received federal loan guarantees, including several PV generation projects, significantly exceed the project size needed for effective technology demonstration.²²

RECOMMENDATION

DOE should assess what has been learned regarding cost, performance, and reliability for solar technologies that have received support in the form of federal loan guarantees and make this information available to the private sector.

Moving forward, DOE has stated that its loan guarantee programs will no longer be available to the types of large-scale PV and CSP facilities they have supported to date.²³ We believe this change is appropriate.

A key objective of any technology demonstration program should be to develop insights regarding, among other things, the cost, technical performance, and reliability of new technologies when deployed at commercial scale.

Pilot-Scale Test Facilities and Simulation Infrastructure

We do not, however, advocate a complete retreat from federal support for solar technology demonstration projects. Instead, DOE should redirect resources toward technology test beds and pilot-scale facilities, while also supporting demonstration projects through cost sharing. This would allow a wider range of solar technologies to move through the demonstration phase of development. Specifically, DOE should support a set of pilot-scale test beds in which new CSP and PV concepts can be evaluated at much lower cost than in a commercial-scale demonstration. For PV, the focus of these pilot facilities should be on new thin-film technologies and novel manufacturing methods; for CSP, the focus should be on system verification and some component manufacturing and testing (e.g., new mirror supports).

DOE has an opportunity to leverage its own facilities such as the National Laboratories to establish test beds and pilot-scale demonstrations. These can be much smaller than the full commercial-scale demonstration plants currently being supported by the Department's loan guarantee programs, but still large enough to provide for the useful and relatively rapid demonstration of new technologies. For CSP, the appropriate scale for such facilities is likely in the range of 5–20 MW_e;^{viii} PV facilities can be smaller, perhaps as small as 1 MW. Such facilities can be utilized for relatively low-cost validation and demonstration or to verify new PV and/or CSP technologies. We expect the risk

DOE should redirect resources toward technology test beds and pilot-scale facilities, while also supporting demonstration projects through cost sharing.

associated with scale-up to full-size commercial units from pilot-scale demonstrations to be larger for CSP systems than for PV systems; we also expect that pilot tests will be needed on a

DOE has a second important opportunity to further leverage its own infrastructure in the area of simulation.

larger scale for CSP than for PV. DOE has previously used this model for the support and demonstration of new technologies in other areas, such as coal gasification. Before adopting this approach, however, the costs to maintain and operate pilot-scale facilities must be considered to ensure that they offer a practical and cost-effective model for validating and demonstrating new solar technologies.

RECOMMENDATION

DOE should direct demonstration support toward a greater number of smaller projects and facilities, such as test beds and pilot plants, that are genuinely demonstration-scale in nature and that involve truly novel PV and CSP technologies.

DOE has a second important opportunity to further leverage its own infrastructure in the area of simulation. The Department has extensive capacity for and experience with simulation, and integrating this infrastructure into current and future solar RD&D work, particularly on advanced materials and device development, would be of appreciable value. Examples of efforts that harness DOE's broad simulation capacity already exist, among them the Consortium for Advanced Simulation of Light Water Reactors, and we believe a similar initiative for solar could be productive.

^{viii}Here the subscript “e” refers to the nameplate electric power generating capacity of the plant in watts.

10.6 CONCLUSIONS

Recent years have seen very significant progress toward reducing the cost of solar electricity, but further cost reductions are needed for solar technologies to be competitive beyond modest levels of penetration. The cost competitiveness of today's primarily crystalline-silicon-based technologies is likely to continue to improve, but only incrementally.^{ix} Furthermore, the solar energy industry is both capable and highly motivated to capture the remaining opportunities. Realizing solar energy's larger long-term potential to become a major source of global electricity supply, however, still demands a step-change in solar costs, and achieving this step-change requires the development of inherently lower-cost new technologies. Here there is a role for government-supported RD&D. To advance PV generation options, we call for new thin-film technologies, based on Earth-abundant materials, that can be manufactured using low-cost processes and in form factors that reduce BOS costs. For CSP, we point to the need for more efficient energy-capture systems, higher-temperature materials, and improved power-cycle efficiencies.

DOE's current budget for solar RD&D places a great deal of emphasis on work aimed at meeting a set of short- and medium-term cost

goals for currently commercial solar technologies. Progress toward these goals will, of course, be welcome. However, this work is unlikely to yield the step-change in costs that will ultimately be needed if solar energy is to play an important role in meeting the challenge of climate change. Therefore, we believe that DOE should redirect its solar RD&D investment toward broad support for fundamental research to advance those nascent high-risk, high-potential technologies that, if successfully developed, could yield the required cost reductions. We also advocate reforms in DOE's support for solar demonstration projects that would enable more rapid assessment of a broader range of new technologies. Such reforms should emphasize cost sharing ahead of loan guarantees and should support the establishment of pilot-scale and test-bed facilities to enable rapid and low-cost technology demonstrations.

Finally, it will be difficult or impossible to achieve the progress needed in solar electricity generation without significant, sustained support for basic research and development. Solar energy has the potential to be the major source of electricity globally. Realizing that potential will require the combined efforts and resources of government, industry, and academia.

We believe that DOE should redirect its solar RD&D investment toward broad support for fundamental research to advance those nascent high-risk, high-potential technologies that, if successfully developed, could yield the required cost reductions.

^{ix}See, for example, the many pathways described in the International Technology Roadmap for Photovoltaic 2014.²⁴

REFERENCES

- ¹DOE budget histories, <http://energy.gov/cfo/reports/budget-justification-supporting-documents>
- ²Congressional Research Service, *DOE FY2011 Congressional Budget Request for EERE*, 2010 http://www.eesi.org/files/sissine_030111.pdf
- ³Data from 1973-2010: DOE budget histories <http://energy.gov/cfo/reports/budget-justification-supporting-documents>. Data from 2011-present: *DOE FY2011 Congressional Budget Request for EERE*, Congressional Research Service, 2010 http://www.eesi.org/files/sissine_030111.pdf
- ⁴Bayh–Dole Act (“Patent and Trademark Law Amendments Act”) Public Law 96-517, December 12, 1980. <http://www.gpo.gov/fdsys/pkg/USCODE-2011-title35/pdf/USCODE-2011-title35-partII-chap18.pdf>
- ⁵U.S. Department of Energy, “SunShot Vision Study,” February 2012. <http://www1.eere.energy.gov/solar/pdfs/47927.pdf>
- ⁶DOE annual budget justifications 2011-2016 obtained from <http://energy.gov/cfo/reports/budget-justification-supporting-documents>
- ⁷U.S. Department of Energy, “SunShot Initiative, Tackling Challenges in Solar – 2014 Portfolio,” The Solar Technologies Office, 2014, http://energy.gov/sites/prod/files/2014/08/f18/2014_SunShot_Initiative_Portfolio8.13.14.pdf
- ⁸Tuffrey, N., G. Richards, and J. Brimacombe, “Two-Wavelength Pyrometry Study of the Combustion of Sulfide Minerals: Part II. Galena and Commercial Lead Concentrates,” *Metallurgical and Materials Transactions B*, 26B, October 1995, 943-958.
- ⁹Fthenakis, V, *CdTe PV: Real and Perceived EHS Risks*, National Center for Photovoltaics and Solar Program Review Meeting, March 2003, <http://www.nrel.gov/docs/fy03osti/33561.pdf>
- ¹⁰Goodrich, A., T. James and M. Woodhouse, *Residential, Commercial, and Utility-Scale Photovoltaic (PV) System Prices in the United States: Current Drivers and Cost-Reduction Opportunities*, 2012, <http://www.nrel.gov/docs/fy12osti/53347.pdf>
- ¹¹*Module Price Index*, pvXchange. (2015) <http://www.pvxchange.com/priceindex/Default.aspx?langTag=en-GB> (accessed 3 February 2015).
- ¹²Green, M., A. Ho-Baillie, and H. Snaith, *Nature Photonics* 8 (2014): 506-514. <http://www.nature.com/nphoton/journal/v8/n7/abs/nphoton.2014.134.html>
- ¹³National Renewable Energy Laboratory, *Best Research-Cell Efficiencies (rev. 12-18-2014)* (2014), http://www.nrel.gov/ncpv/images/efficiency_chart.jpg
- ¹⁴Tuller, H., *Solar to Fuels*. Forthcoming MIT Future of Solar Energy study related publication. (2015) mitei.mit.edu/futureofsolar
- ¹⁵Pilawa-Podgurski, R., and D. Perrault, “Sub Module Integrated Distributed Maximum Power Point Tracking for Solar Photovoltaic Applications,” *IEEE Transactions on Power Electronics* 28:6 (2013) 2957-2967. <http://ieeexplore.ieee.org/stamp/stamp.jsp?arnumber=6339082>
- ¹⁶Gregory J. Kolb, Clifford K. Ho, Thomas R. Mancini, and Jesse A. Gary, *Power Tower Technology Roadmap and Cost Reduction Plan*, Sandia Report SAND2011-2419, Sandia National Laboratories, 2011.
- ¹⁷C. W. Forsberg, “Sustainability by Combining Nuclear, Fossil, and Renewable Energy Sources,” *Progress in Nuclear Energy* 51, 192-200 (2009).
- ¹⁸Walter, M., et al. “Solar Water Splitting Cells.” *Chemical Reviews* 110, 11 (2010): 6446-6473. <http://pubs.acs.org/doi/pdf/10.1021/cr1002326>
- ¹⁹Hales, R.. “The DOE Loan Program Office, A Government Success Story,” *Clean Technica* <http://cleantechnica.com/2014/04/27/doe-loan-program-office-government-success-story/>
- ²⁰Jenkins, J.. “Solyndra’s Failure Is No Reason To Abandon Federal Energy Innovation Policy,” *Forbes*, Accessed March 30, 2015: <http://www.forbes.com/sites/energysource/2011/09/02/solyndras-failure-is-no-reason-to-abandon-federal-energy-innovation-policy/>
- ²¹<http://lpo.energy.gov/our-projects/>
- ²²U.S. Department of Energy, “LPO Financial Performance, November 2014” <http://energy.gov/sites/prod/files/2014/11/f19/DOE-LPO-Financial%20Performance%20November%202014.pdf>

²³Renewable Energy & Energy Efficiency Projects - Loan Guarantee Solicitation Presentation, DOE Loan Program Office, July 2014 http://energy.gov/sites/prod/files/2014/07/f17/REEE%20Solicitation%20Presentation%20July%202014_0.pdf

²⁴Forstner, H. et al., *International Technology Roadmap for Photovoltaic*, Ed. 5 (March 2014) <http://www.itrpv.net/Reports/Downloads/2014/>

The hyperlinks in this document were active as of April 2015.

Appendix A – The Solar Resource

A.1 INTRODUCTION

The solar resource is significantly larger than every other energy source available on earth.^{1,i} Roughly 174,000 terawatts (TW) of power are continually delivered by solar radiation to the upper level of the earth's atmosphere. Given that global average power consumption totals roughly 17 TW,² the solar energy that strikes the earth in one hour is more than enough to supply all of humanity's current energy needs for one year. With the exception of nuclear, geothermal, and tidal energy, solar energy is the root source of all energy resources used by humans — from the heat that drives the wind and the hydrologic cycle to the photosynthetically-derived chemical energy stored in fossil fuels. The solar resource is freely available and — compared to other energy resources — relatively evenly distributed across the globe.

Nevertheless, the solar resource is fundamentally distinguished from other energy resources by its *intermittency*. **At a given location on the earth's surface, the solar resource suffers from stochastic *unpredictability* (fluctuations over time spans of minutes to days resulting from cloud cover and weather systems) and deterministic *variability* (predictable fluctuations over time spans of days to months resulting from the earth's diurnal rotation and seasonal changes).** Despite its large size, the solar resource is also *dispersed*. Tens of thousands of square kilometers of land would need to

be covered by solar energy harvesting systems if solar power is to play a significant role in the transition to low- and zero-carbon energy sources that is necessary to avoid dangerous levels of anthropogenic climate change.^{3,4,5,6}

This appendix provides an introduction to the scope and limitations of the solar resource. Section A.2 describes the physical nature of solar radiation and its interaction with the earth and its atmosphere. Section A.3 describes the intrinsic intermittency of the solar resource, distinguishing between stochastic unpredictability and deterministic variability. Section A.4 discusses variability in the solar resource over different geographic regions. Section A.5 identifies the scale of electricity production that is realistically attainable from the solar resource and estimates the land area required to meet a significant portion of U.S. electricity demand using solar power.

A.2 NATURE OF THE SOLAR RESOURCE

The vast majority of light that strikes the earth originates from the sun, which for the past 4.6 billion years has sustained a thermonuclear fusion reaction that produces the energy equivalent of roughly 1 trillion atomic bombs per second.⁷ This reaction heats the sun's surface to approximately 5,500°C and causes it to emit radiation via the same mechanism by which a heated tungsten filament produces visible light in an incandescent lightbulb.⁸

ⁱEven utilizing every deuterium atom on earth for nuclear fusion would only generate 1/500th of the energy that will be delivered to the earth by sunlight over the sun's remaining 5 billion years of life.

Sunlight takes 8.3 minutes to travel the 150 million kilometers that separate the sun from the earth.⁹ Because of this great propagation distance, rays of light spreading outward from the sun strike the upper level of the earth's atmosphere along mostly parallel paths. The sun can thus be considered a source of collinear light. **Sunlight strikes the top of the earth's atmosphere with an average intensity of 1,366**

watts per square meter (W/m^2); this quantity is known as the solar constant (Figure A.1).¹⁰ This intensity varies by $\pm 3.3\%$ over the course of the year as the earth's slightly elliptical orbit takes it closer to and further away from the sun.¹¹ There are also minor variations (less than $\pm 0.1\%$) over the course of the sun's 11-year sunspot cycle.¹²

Figure A.1 Reduction in Average Solar Power Density from Different Factors^{10,16,18,19}

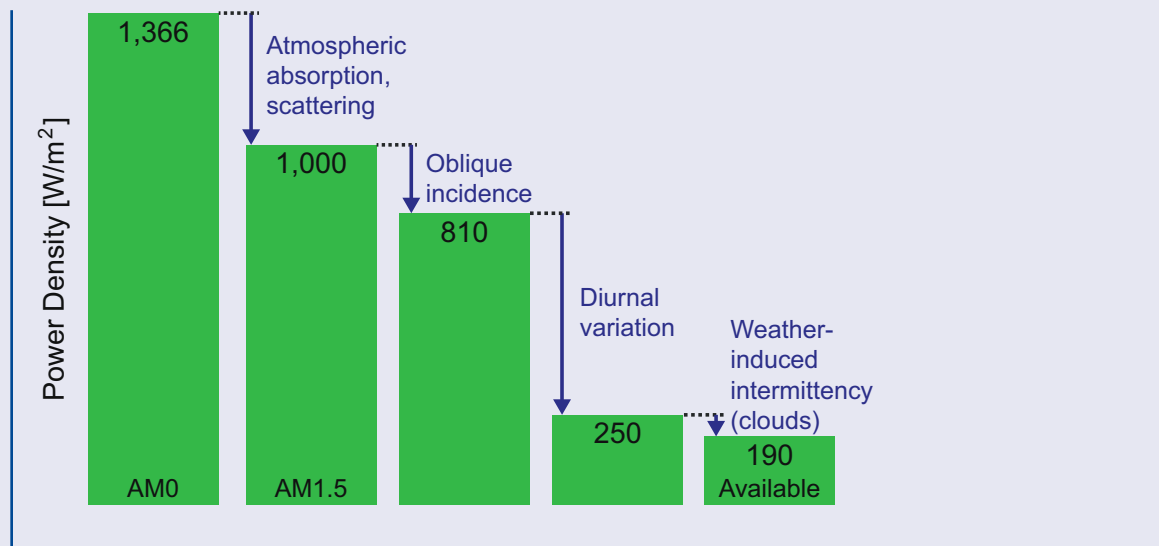

Sunlight traveling from the top of the atmosphere to the earth's surface is both *scattered* and *absorbed* by air molecules, particulate

matter, and clouds (see Box A.1 for a breakdown of atmospheric sources of attenuation and their effect on the solar spectrum).

BOX A.1 THE SOLAR SPECTRUM AND THE EFFECTS OF ATMOSPHERIC LOSSES

While the earth's atmosphere is largely transparent to visible light, interactions with the atmosphere have important effects on the intensity, spectrum, and diffusivity of solar illumination at the earth's surface.

Every surface emits thermal radiation, also known as *blackbody radiation*. The temperature of the surface determines the spectrum of this radiation, which is commonly reported as a function of the wavelength of light in nanometers. The spectrum of solar radiation at the top of the earth's atmosphere closely matches the spectrum for a blackbody emitter at 5,505°C, with a peak spectral irradiance in the visible portion of the spectrum between 400 and 750 nanometers in wavelength and a long tail extending deep into the infrared. During its transit through the atmosphere, sunlight interacts with air molecules (primarily water

vapor, carbon dioxide, methane, nitrous oxide, and ozone) and portions of the light are absorbed or reflected. The absorption of light by air molecules occurs in distinct regions of the spectrum, giving rise to the sharp dips seen in the AM1.5 spectra in Figure A.2a and the greenhouse effect depicted schematically in Figure A.2b. Scattering most strongly affects shorter (bluer) wavelengths; hence, light scattered from the atmosphere to the earth's surface appears blue. The sun at sunrise and sunset appears red as a result of the increased atmospheric distance through which direct sunlight must travel at these times. The AM1.5 global spectrum includes the contribution of diffuse light scattered to the earth's surface from the atmosphere, and is thus more intense at blue wavelengths than the AM1.5 direct spectrum, which excludes scattered light. Clouds are responsible for an additional amount of light absorption and scattering. These contributions are represented schematically in Figure A.2a.

Figure A.2 The Solar Spectrum (a) and the Influence of Atmospheric Effects on the Earth's Radiative Energy Balance (b)

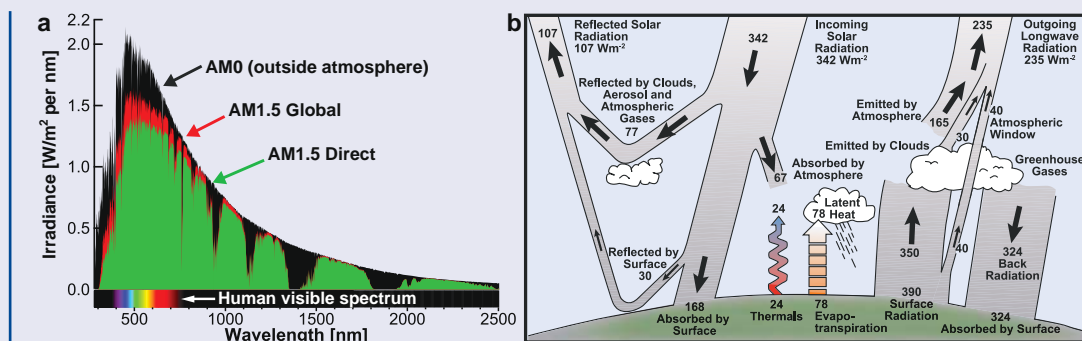

Note: The data in Figure A.2a are from ASTM.¹³ Figure A.2b is reproduced from Kiehl and Trenberth¹⁴ and IPCC.¹⁵

Interaction with the atmosphere thus decreases the intensity of sunlight from the value measured at the outermost edge of the atmosphere. The effects of atmospheric attenuation are described by the *air mass* factor, where an air mass of 1 (“AM1”) corresponds to the intensity of sunlight at the earth’s surface when the sun is directly overhead (in other words, at the *zenith*) and the light has passed through a column of air equal in thickness to the atmosphere (Figure A.3). The solar constant therefore corresponds to “AM0” conditions. An air mass

of 1.5 corresponds to the intensity of sunlight when the sun is 48.2° from the zenith and the sunlight has passed through a column of air 1.5 times longer than the thickness of the atmosphere. Since the sun is rarely directly overhead, **AM1.5 is used as a typical standard intensity in the testing and reporting of solar cell efficiencies. AM1.5 conditions, representative of standard midday illumination across many of the world’s major population centers, correspond to $1,000 \text{ W/m}^2$.**¹⁶

Figure A.3 Incident Solar Radiation, Effect of Seasonal Variation (a), and Effect of Atmospheric Attenuation (b)

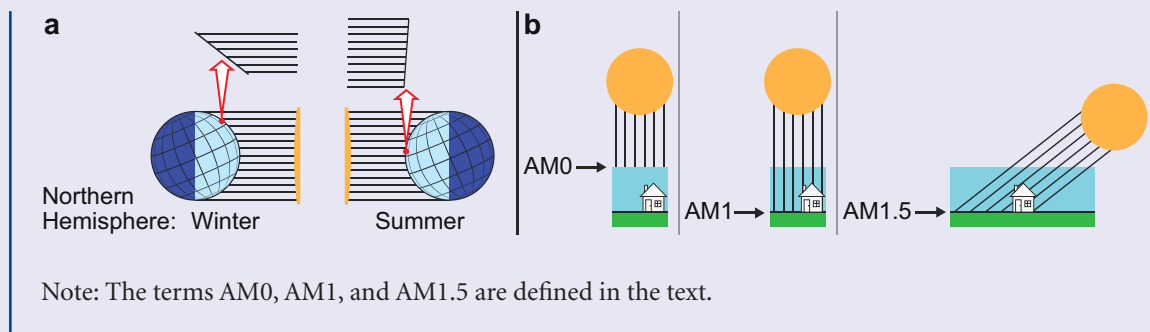

The major sources of variation in solar intensity across time and geographic location arise from the varying obliquity of incoming solar radiation across different latitudes, the earth’s revolution around the sun (*seasonal* variation), the earth’s rotation about its own axis (*diurnal* variation), and changes in weather. In Section A.2, we consider the impact of the temporal variation induced by these phenomena. Here, we are concerned only with their impact on time-averaged illumination.

For a given location in the Northern Hemisphere, the sun’s rays will generally strike the earth’s surface at an oblique angle, as shown in Figure A.3. Sunlight strikes the surface at

a shallower angle in the winter than in the summer as a result of the earth’s 23.4° axial tilt, giving rise to seasonal variations in insolation. In general, the amount of solar energy available to be harvested per unit area of the earth’s surface decreases with increasing latitude, as shown in Figure A.4. At 38° N , the average latitude for the United States, the tilt of the earth decreases the average daytime solar intensity (neglecting the influence of weather) to roughly 810 W/m^2 .

Figure A.4 Effects of Latitude on Daily and Yearly Insolation

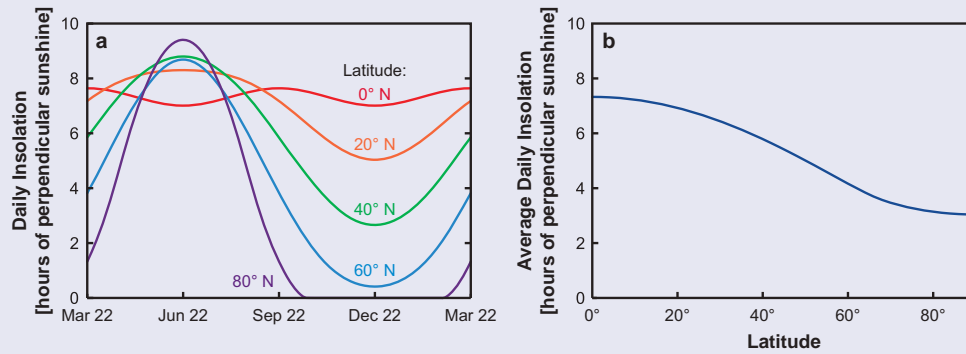

Note: Figure A.4 shows the effect of latitude on daily insolation throughout the year (a) and the effect of latitude averaged over a year (b). Both plots represent conditions at the top of the earth's atmosphere and thus neglect the influence of weather. Adapted with permission from Jaffe and Taylor.¹⁶

The earth's diurnal rotation further reduces the average solar intensity at a given point on the earth's surface. Figure A.5 shows three different metrics for solar intensity in Milford, Utah, over the span of a cloudless day in June.¹⁷ *Global horizontal* intensity reports the total amount of sunlight incident on a flat horizontal panel pointed directly overhead. *Direct normal* intensityⁱⁱ reports the sunlight incident on a panel pointed directly at the sun using a continually adjusted two-axis tracking mount, excluding diffuse illumination scattered from clouds and from the atmosphere. *Diffuse*

intensity reports solely the sunlight scattered from the atmosphere, with the direct normal component excluded. None of these metrics reports measurable solar intensity before dawn or after dusk. Integrating over a complete day at the average latitude of the United States, diurnal variation thus decreases the temporally averaged solar intensity over the course of a year to roughly 250 W/m². Box A.2 explains the relevance of direct and diffuse radiation to solar harvesting systems that employ *tracking* and *concentration*.

Figure A.5 Irradiance Profiles at the Earth's Surface on a Cloudless Day¹⁷

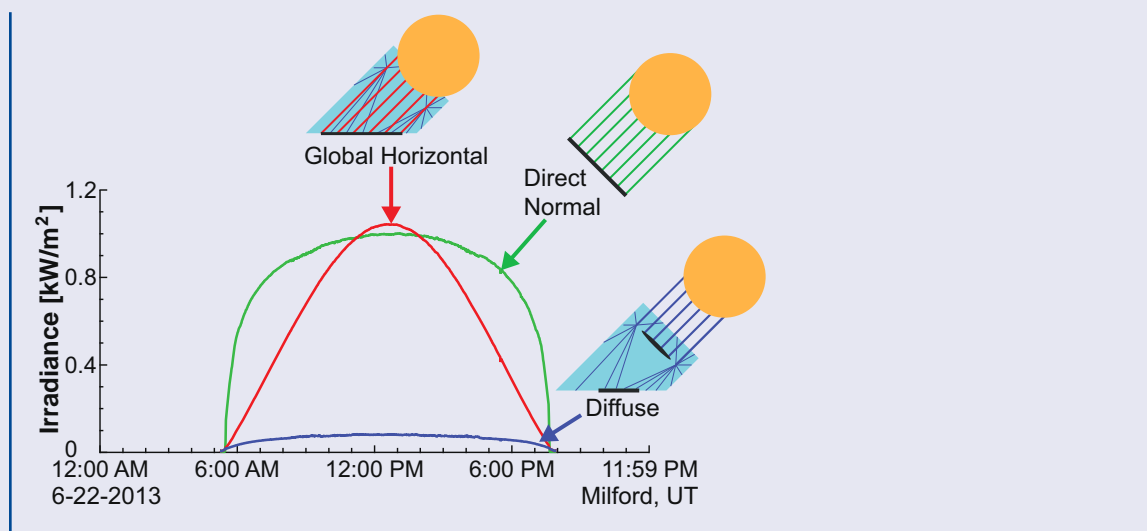

ⁱⁱIn this context, *normal* refers to the direction perpendicular to the surface plane.

When the effects of cloud cover and weather-induced shading are factored in along with the effects noted above, **the available global horizontal solar intensity averaged across the contiguous United States over the course of a year amounts to roughly 190 W/m² or 4.5 kilowatt-hours per square meter (kWh/m²) per day.**^{18,19} It bears emphasizing that this number represents an average over

an entire year across a very large land area (roughly 8 million square kilometers or 3 million square miles) and does not factor in the significant efficiency losses that are inevitably incurred when converting solar illumination to electricity or chemical energy. We address these considerations in the remainder of this appendix, starting with the issue of temporal variability.

BOX A.2 CONCENTRATION AND SOLAR TRACKING

Some solar harvesting systems focus, or *concentrate*, sunlight from a large collector area onto a smaller active area using mirrors or lenses. Concentration is employed in concentrating solar power (CSP) systems to heat a working fluid to much higher temperatures than would be attainable using non-concentrated sunlight. In PV systems, where concentration is used much less frequently, it enables the use of smaller, higher-efficiency solar cells. Simple geometric optics dictate that, as the concentration factor increases, the *acceptance angle* of incoming light decreases. In much the same

way as a telescope must be precisely aligned with its target to achieve a highly magnified image, concentrating solar systems must employ active *solar tracking* to keep the collector aligned with the sun as the sun's position in the sky shifts throughout the day and the year (non-concentrating PV systems may also employ solar tracking to increase each PV panel's power output). As a result of their small acceptance angle, concentrating systems can only access the collinear light rays of direct normal radiation. Diffuse radiation, which demonstrates no angular alignment, cannot be harvested by concentrating systems.

A.3 INTERMITTENCY: TEMPORAL UNPREDICTABILITY AND VARIABILITY

As illustrated by Figure A.6 (reproduced here from Figure 1.2 in Chapter 1 of this study), incident solar radiation at the earth’s surface varies on many temporal scales over the course of a year. **An unavoidable challenge inherent in utilizing solar power to meet a significant portion of humanity’s energy needs lies in converting this highly intermittent resource, which is characterized by dramatic fluctuations in magnitude across wide temporal scales, into a steady and highly reliable source of electricity.**

The most obvious temporal characteristic of the solar resource is its daily fluctuation. Longer variations are also seen over the course of the year: the length of the day as well as the peak and integrated irradiance increase moving into the summer and decrease moving into the

winter. At the shortest timescales, shifting cloud cover can cause rapid variations in solar intensity: solar irradiance can drop by a factor of five or more in the span of minutes as a result of passing clouds. The difference between a completely sunny day and a completely overcast day can amount to a 15-fold difference in integrated irradiance, and weather systems that produce overcast conditions sometimes persist for several days.

Some of these changes in intensity — including short, minute-to-minute changes as well as day-to-day fluctuations due to weather — are random and are labeled here as sources of *unpredictability*. Other fluctuations — including diurnal and seasonal variation — are broadly predictable and labeled here as sources of *variability*. We consider each of these features of the solar resource in turn, starting with unpredictability.

Figure A.6 Complete Solar Irradiance Profile in Golden, Colorado for the Year 2012

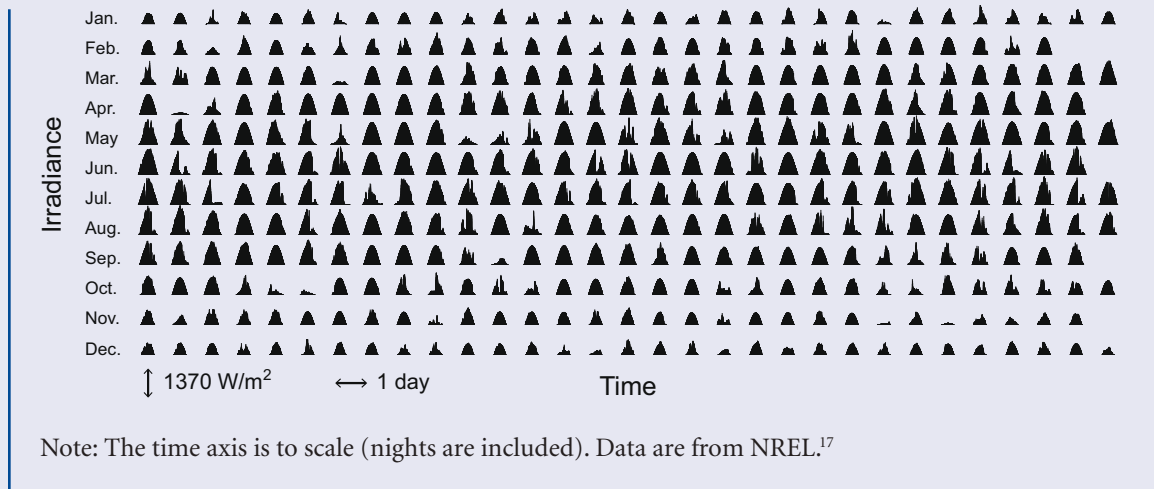
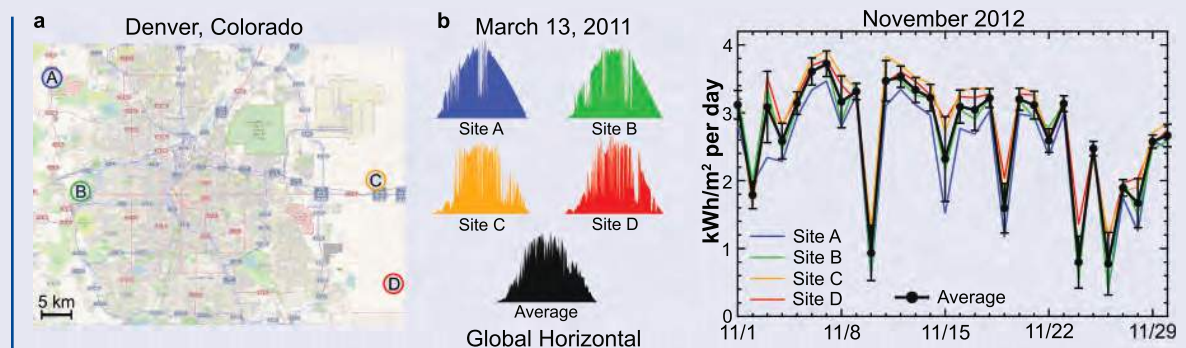

Figure A.7 shows the solar intensity at four different measurement stations across the Denver, Colorado greater metropolitan area over two different time periods.^{17,20} On March 13, 2011, Denver experienced unpredictable cloud cover and steep changes in irradiance occurred on minute-to-minute timescales across the four measurement locations. Averaging the irradiance measured at the four different locations (Figure A.7b) reduces the scale of these rapid short-term fluctuations and smooths out the temporal profile. This observation suggests that **small-scale grid interconnectivity, over distances greater than the typical size of a cloud, can to some extent mitigate the minute-to-minute unpredictability of the solar resource over the course of a day,** even without relying on energy storage or non-solar sources of energy for backup.

Figure A.7c shows the daily insolation at each of the four Denver-area sites over the month of November 2012, as well as the daily insolation averaged across the four sites for the same month. In this case, small-scale grid interconnectivity does not significantly reduce fluctuations in resource availability: insolation still varies by more than a factor of three from some days to the next. **Larger-scale grid interconnectivity, similar in spatial extent to the size of weather systems, or suitable non-solar technologies (e.g., energy storage; complementary, curtailable, or dispatchable energy sources; or demand management) would be required to smooth out these day-to-day fluctuations.**

While long-term weather and cloud patterns are unpredictable, some trends observed in Figure A.6 are predictable far into the future. Diurnal variation is highly predictable, though smoothing out this source of variation in the absence of a globally integrated electric grid would require the use of non-solar technologies.

Figure A.7 Irradiance Profiles at Four Sites in the Denver Area



Note: Figure A.7 shows irradiance profiles for four separate measurement sites in the Denver area, including (a) a map showing the location of the measurement sites;²⁰ (b) the global horizontal irradiance profile at each of the sites and the four-site average on March 13, 2011, a day with many minute-to-minute variations; and (c) daily average insolation for each site and for the four-site average over the month of November 2012, a month with many day-to-day variations.¹⁷

Figure A.8 Daily Irradiance and Monthly Insolation Profiles for Different Solar Panel Arrangements

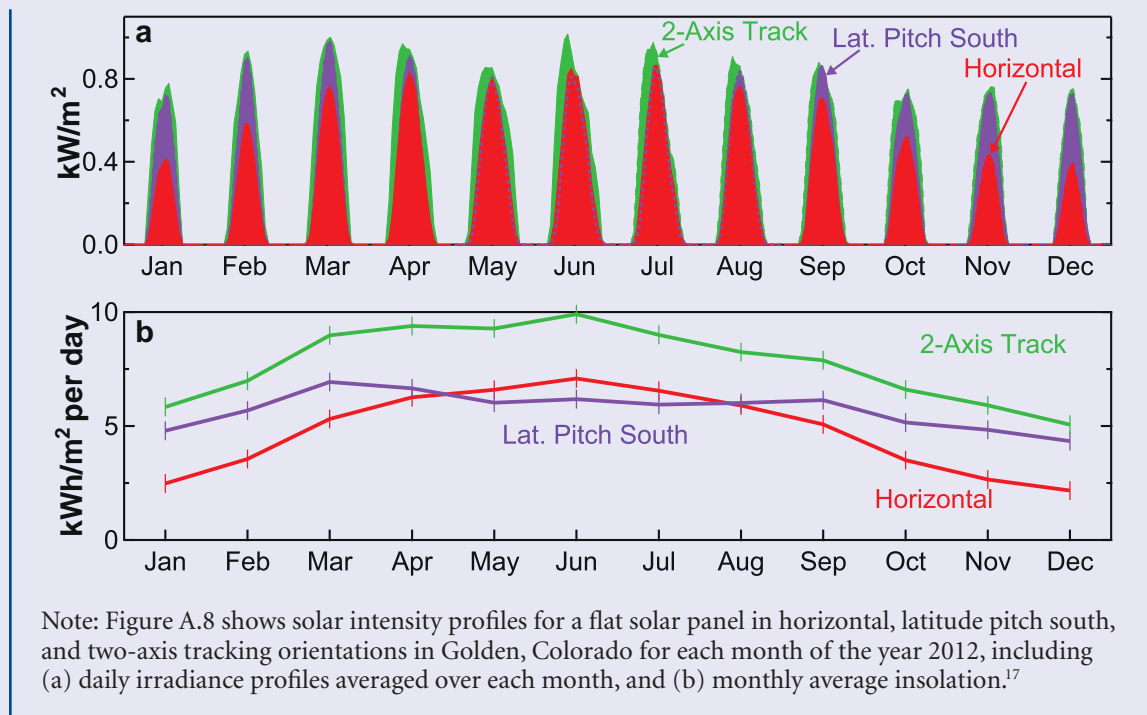

Seasonal variations are also somewhat predictable over the course of a year. Figure A.8a shows the average daily irradiance profile for each month of the year 2012 in Golden, Colorado for three different solar panel arrangements: a panel pointed directly toward the zenith on a horizontal surface, a panel tilted south at a pitch equal to the latitude (40° for Golden), and a panel mounted on a two-axis tracking system continually pointed toward the sun. Figure A.8b shows monthly average insolation over the course of the year.

The horizontal and two-axis tracking results follow expected seasonal trends. Average insolation is lowest in the winter (reaching

a minimum in December) and highest in the summer (reaching its maximum in June). For both systems, there is more than a twofold difference in average insolation between December and June. On the other hand, **when the panel is tilted south at latitude pitch, these seasonal variations largely even out.**ⁱⁱⁱ At this angle, the orientation of the panel effectively splits the difference between the summer and winter locations of the noonday sun. This orientation results in a slight drop in insolation during the mid-summer months, but a smoother profile throughout the year and — in this location — a higher annual energy generation per panel.^{iv}

ⁱⁱⁱPV panels installed in the Southern Hemisphere would be tilted north to achieve the same effect.

^{iv}When location-specific diffuse irradiance profiles and seasonal shifts in cloud cover are taken into account, the optimal tilt for maximum annual energy generation per panel can vary from latitude pitch. If a location experiences cloudy winters and hazy summers, for example, a shallower tilt angle may be used to capture more diffuse light from the summer sky. Shallower tilt angles may also be used to minimize wind loading.

It is worth noting that **complete coverage of a given land area with horizontal panels results in the maximum possible harvest of solar energy**. While a given area of panel can harvest more sunlight by being tilted toward the sun or by being placed on a tracking system, these architectures result in greater shading of the surrounding area, increasing the optimal spacing between panels. Relative to horizontal installations, tracking systems maximize power output per panel (a clear benefit for expensive panels), but reduce overall power output for a given area of occupied land.²¹

A.4 GEOGRAPHIC VARIABILITY

We have noted that increasing the geographic extent of solar energy harvesting systems can smooth out some of the intrinsic unpredictability of the solar resource. However, insolation also varies predictably between different geographic locations. Figure A.9 illustrates geographic variation in average insolation

across the United States; insolation values are shown for both direct normal and global latitude pitch and are averaged over three time periods (an entire year, the month of January, and the month of July).¹⁸

Figure A.9 shows large seasonal and geographic differences in the magnitude and character of the solar resource in the United States. Clearly the American Southwest offers the most auspicious conditions for solar power, with nearly twice the average direct normal solar intensity of the Northwest and Northeast. It is also clear from these maps that different solar harvesting technologies are optimal for different locations. Concentrating systems primarily make use of direct normal illumination and therefore require tracking to operate efficiently, while non-concentrating systems can harness both direct and diffuse illumination. **In areas characterized by frequent cloud cover (particularly the Northwest and Northeast) and diffuse sunlight, non-concentrating flat**

Figure A.9 Insolation Maps for the United States

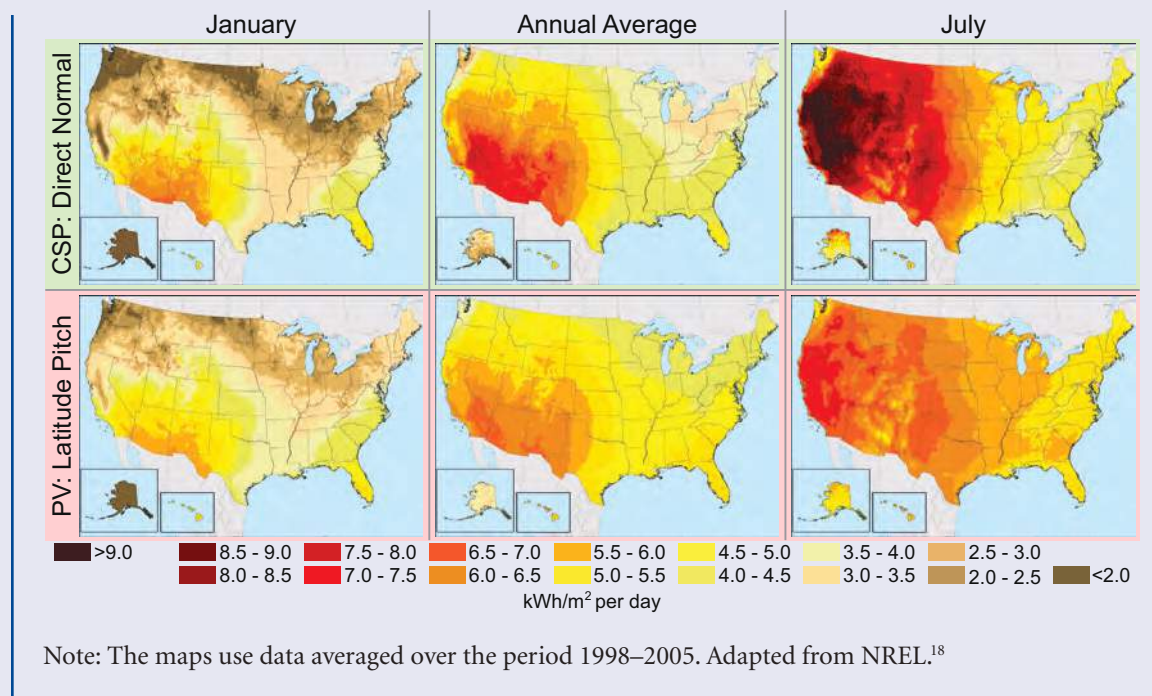

panels that capture global insolation will perform better than a concentrating system that employs two-axis tracking to capture direct normal insolation. On the other hand, concentrating systems offer a distinct advantage in hot, dry areas with little cloud cover.

As noted in Figure A.4, average insolation tends to increase with decreasing latitude. However, Figure A.9 makes clear that latitude is not the only defining factor for solar insolation. Because of differences in weather patterns, global and direct normal solar intensities in the month of July vary more with longitude than they do with latitude.

Figure A.10 summarizes geographic and temporal variations in the global horizontal solar resource for various cities across the United States.^{22,23} Average insolation values for the winter, summer, and year as a whole

generally increase for decreasing latitude, but the range of values for a particular time interval at a given latitude is large. For example, the yearly average insolation for Las Vegas, Nevada is 30% higher than that for Nashville, Tennessee, despite the small (0.2°) difference in latitude between these two cities. The magnitude of seasonal variation in insolation also increases at higher latitudes. In Fairbanks, Alaska, for example, the average insolation in July is 30 times greater than the average insolation in January. In Honolulu, Hawaii, by contrast, the average insolation for these two periods varies by only a factor of 1.6. However, as noted above, installing PV panels at latitude pitch would mitigate some of this seasonal variation. Across the contiguous United States, average annual global insolation varies by roughly a factor of 1.8, between 3.2 kWh/m² per day for Seattle, Washington and 5.8 kWh/m² per day for El Paso, Texas.

Figure A.10 Geographic and Seasonal Variability in Insolation for Specific U.S. Cities

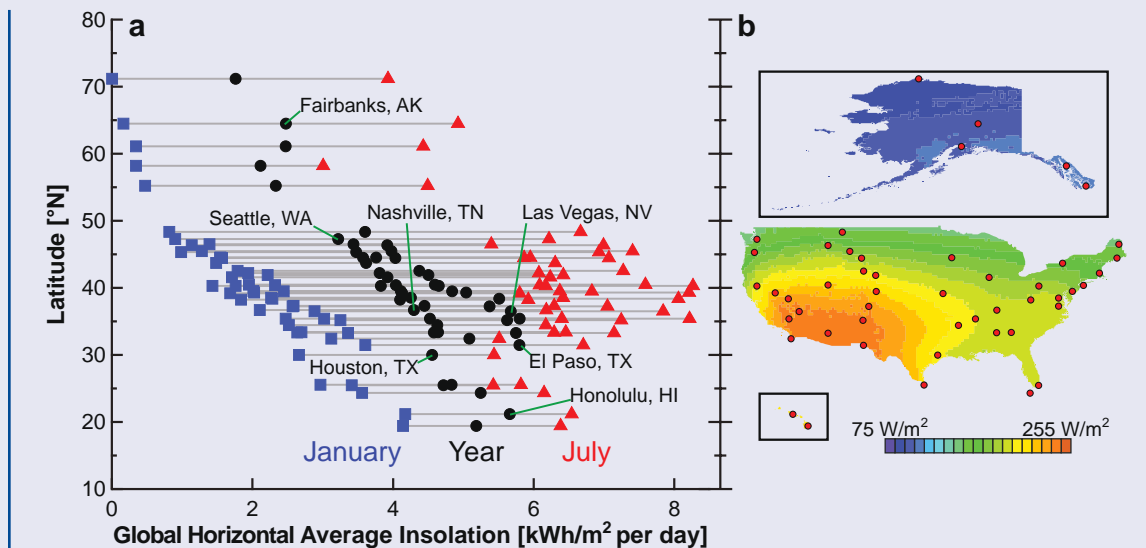

Note: In Figure A.10a, blue squares represent the average insolation for the month of January; red triangles represent the average insolation for July; black circles represent the yearly average insolation. Data are for the year 2010.²² Each triplet of symbols connected by a gray line represents one city. Figure A.10b shows the locations of the cities plotted in (a) on a solar irradiance map of the United States, using the same vertical (latitude) axis. Alaska and Hawaii are horizontally offset. Map adapted from Albuissou, Lefevre, and Wald,²³ Copyright © 2006, Mines ParioTech/Armines, all rights reserved.

This difference in annual average insolation across the United States is notable, as it implies that a solar installation providing 1 megawatt-hour (MWh) of energy per day in Seattle would require nearly twice the number of solar panels and twice the land area of a 1-MWh-per-day solar installation in El Paso (or, equivalently, that a 1-MW_p PV array in El Paso would provide nearly twice the annual energy output of a 1-MW_p array in Seattle).

However, **viewed on a global scale, sunlight is still one of the most uniformly distributed energy resources available.** Figure A.11 (reproduced here from Figure 1.1 in Chapter 1 of this study) shows a map of average solar intensity across the globe, with histograms of land area, population, and average irradiance as functions of latitude and longitude.^{23,24} The density of the solar resource varies by no more than a factor of three across heavily settled areas, and the vast majority of the human

Figure A.11 Worldwide Distribution of the Solar Resource

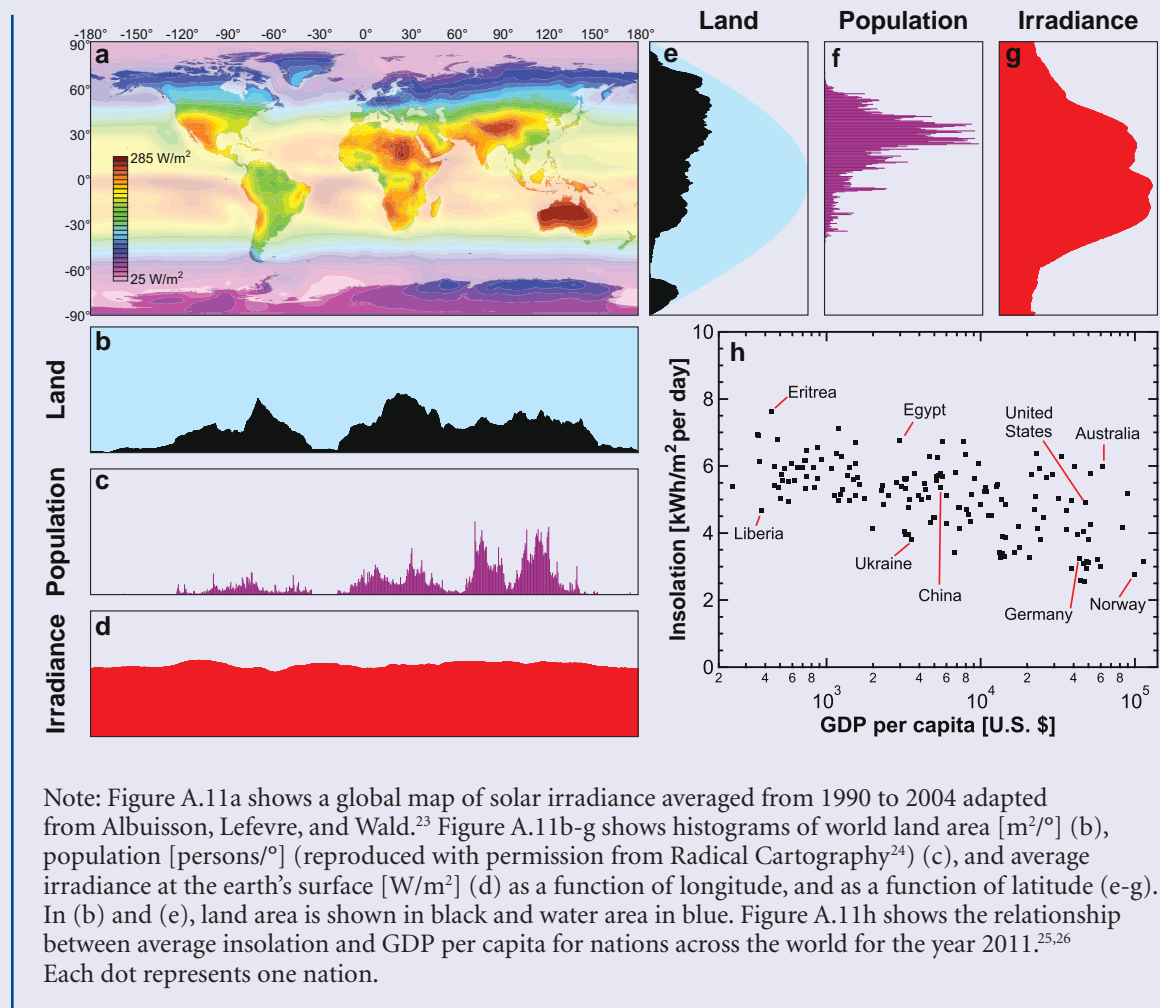

population has direct local access to the solar resource.^v These statements do not apply to fossil fuels and other extractive sources of energy. Access to the solar resource is also not highly correlated with wealth (here quantified in the conventional terms of GDP per capita), as shown in Figure A.11h. Average insolation varies across a much smaller range than GDP per capita, and the lack of a strong correlation between these two metrics implies that poorer nations are not fundamentally disadvantaged in their access to the solar resource.^{vi}

A.5 SCALE OF THE SOLAR RESOURCE

Having described the nature of the solar resource, its intermittency, and its geographic variability, we now turn to the scale of the resource and consider the land area that would be required to supply 100% of projected U.S. electricity demand in 2050 using solar energy

(an ambitious but illustrative example). This example is further explored in Chapter 6 of this report (specifically, Section 6.1 and Figure 6.2).

As noted in Section A.2, the average power density of sunlight at a point on the earth's surface is attenuated relative to the solar constant by a combination of atmospheric absorption and scattering, the earth's tilt and rotation, and cloud cover. The time- and spatially-averaged solar power density over the land area of the contiguous United States is roughly 190 W/m² or 4.5 kWh/m² per day. Converting this power to useful electrical or chemical energy engenders further power losses, as shown in Figure A.12. This discussion takes a flat-panel silicon PV array, operating under the average solar intensity of the contiguous United States, as an example; observed power losses would be different for different PV or CSP systems.

Figure A.12 Power Conversion Losses for Solar PV^{21,27,28,29,30,31,32,33,34,35}

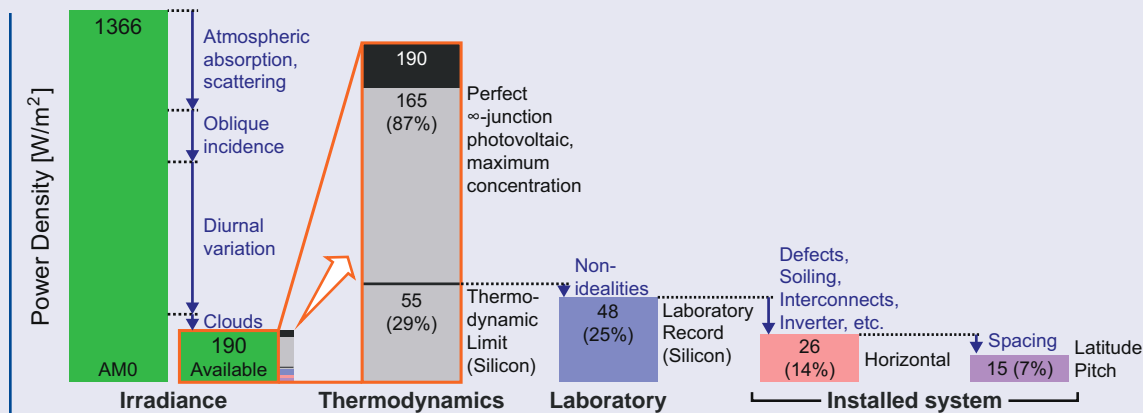

Note: Figure A.12 shows reductions in available power density for solar energy systems, including common losses incurred during the conversion of sunlight to electricity by photovoltaic cells.

^v Areas in the Arctic and Antarctic Circles experience 24-hour periods without sunlight during the winter.

^{vi} Of course, there are large differences between rich and poor nations in terms of access to capital and infrastructure that could facilitate the manufacture, distribution, and incorporation of solar energy systems.

A more detailed discussion of solar PV technologies is the focus of Chapter 2 and Appendix B, but we briefly address the efficiency losses inherent to this technology to explain this analysis. The maximum efficiency allowed by the second law of thermodynamics for a fictional, perfect PV device that harvests the complete energy of each incident photon, under the maximum possible light concentration factor,^{vii} is 86.8%.²⁷ For a real absorbing material such as silicon, which harnesses only a fixed amount of energy from each photon above a critical threshold of energy, the thermodynamic maximum efficiency is roughly 33%.^{28,29,30} Inherent defects limit the maximum reported laboratory efficiency for silicon PV cells to 25%.³¹ Even greater losses are incurred for an installed array of PV modules: losses from manufacturing defects, panel soiling, interconnects, and the direct-current-to-alternating-current (dc-to-ac) inverter decrease the final installed system efficiency to roughly 14% for horizontal panels with complete ground coverage.^{viii} The greater inter-panel spacing required for latitude-tilt orientations decreases the efficiency per unit land area to roughly 7% at the average latitude of the contiguous United States. This efficiency corresponds to a net power density under average U.S. illumination conditions of roughly 15 W/m² or 0.36 kWh/m² per day.^{21,34,ix}

The average electric power consumption of the United States in the year 2050 is projected to total approximately 0.5 TW, which is equivalent to an average power consumption density of roughly 0.05 W/m² over the land area of the United States.³⁶ Using the average net delivered solar power density of 15 W/m² calculated above for panels at latitude tilt (and assuming that every kWh of energy produced by solar generators can be fully utilized to meet demand regardless of when it is generated), **roughly 33,000 square kilometers (km²) of land area (0.4% of the land area of the United States, or roughly half the land area of West Virginia) would need to be covered with solar PV arrays to fully meet the nation's electricity needs.**

Note that this rough calculation assumes a uniform density of solar installations across the United States operating with the industry average multicrystalline silicon module efficiency. If solar arrays were instead only installed in areas with insolation of at least 5.5 kWh/m² per day (the average global horizontal insolation in Arizona), using current industry-leading modules (21% efficiency³⁷) and horizontal installations with complete ground coverage, the land-use requirement for PV arrays drops to 12,000 km², or roughly the combined land

^{vii}The maximum possible concentration factor for sunlight is roughly 45,900x, which corresponds to the situation in which a flat cell “sees” the sun focused or reflected onto it from every possible direction. This concentration factor is equal to the reciprocal of the fraction of the sky occupied by the disk of the sun, viewed from the earth’s surface.

^{viii}We assume a module efficiency of 17.0%,³² combined system losses of 14%,³³ and inverter efficiency of 96%.³³

^{ix}At the average U.S. latitude of 38°N, the optimal ground coverage ratio to avoid panel shading is roughly 0.5. Lower ground coverage ratios would be optimal at higher latitudes and higher ratios at lower latitudes. The stated power density of 15 W/m² takes into account the slightly higher average intensity available to panels at latitude pitch (5.2 kWh/m² per day, versus 4.5 kWh/m² per day for horizontal panels).³⁵

BOX A.3 LAND AVAILABILITY FOR CONCENTRATING SOLAR POWER

The analysis of land availability for solar power generation presented in the main text of this appendix applies only to photovoltaics. A similar analysis can be used to estimate land requirements for the large-scale deployment of CSP systems, which make use of direct normal (rather than global) solar radiation. As discussed in Chapter 3 and Mehos and Kearney,⁴⁰ CSP is subject to more stringent land-type requirements than PV, and only regions with insolation greater than 5.0 kWh/m² per day and ground slope less than 5% are considered amenable to CSP development.⁴¹ Figure A.13 shows the availability of the direct normal solar resource in the United States, filtered by these geographic

requirements. To estimate the land required to meet 100% of U.S. electricity demand using CSP, we utilize the model system described in Fthenakis and Kim³⁴: we assume a CSP system employing a parabolic trough collector with a total system efficiency of 10.7% and a ground-coverage ratio of 29%. The land required to generate 0.5 TW of electricity from CSP utilizing only the highest-insolation areas in Figure A.13b would be roughly 50,000 km², roughly 50% higher than the total estimated in the PV example for uniform PV installation across the contiguous United States. Deployment of CSP systems at a uniform density across the United States increases the estimated land requirement to 80,000 km² to generate the same amount of electric power.

Figure A.13 Direct Normal Solar Insolation across the United States

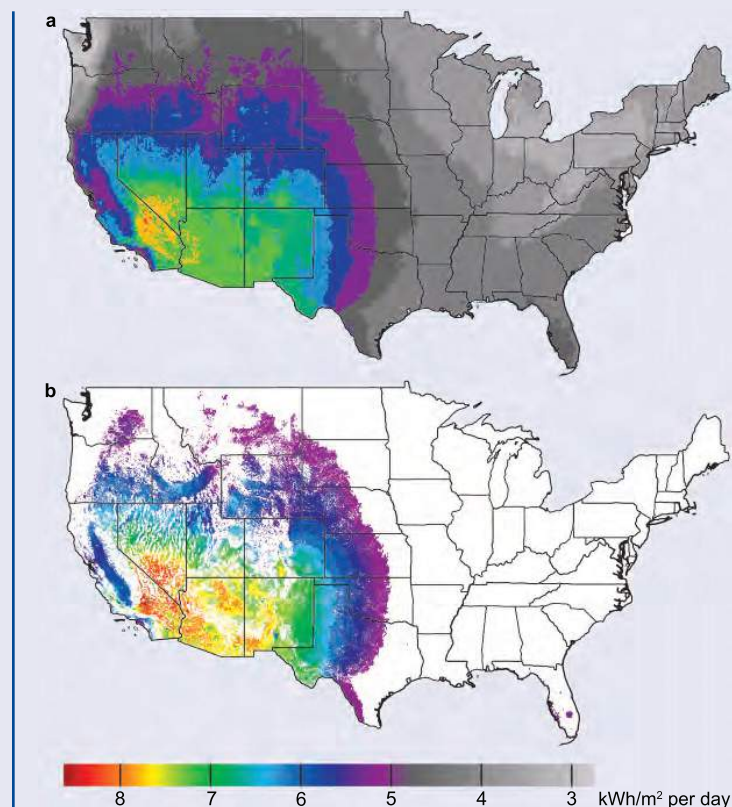

Note: Figure A.13a shows direct normal insolation for the full area of the contiguous United States. Figure A.13b is filtered to include only those areas with insolation greater than 5.0 kWh/m² per day and ground slope less than 5%. Adapted from NREL.⁴¹

area of the White Sands Missile Range and Dugway Proving Ground (neglecting resistive losses due to long-range transmission).^{38,39} Figure 6.2 in Chapter 6 compares the land required to meet 100% of projected U.S. electricity demand in 2050 using solar PV with the amount of land currently devoted to other distinct uses and shows that **the land requirement, while large, is comparable to the amount of land currently dedicated to other energy industries and to national defense.** Box A.3 discusses the results of a similar land-use estimation for CSP.

In conclusion, the global and national solar resource is both large and diffuse. Roughly 0.4% of the land area of the United States, or 33,000 square kilometers, would need to host PV arrays to fully supply projected U.S. electricity demand in 2050. While large, this area is comparable to the area currently devoted to other distinct uses. Supplying a substantial portion of humanity's energy demand using solar would require some combination of energy storage, large-scale grid interconnectivity, and complementary, dispatchable, or curtailable energy technologies to overcome unavoidable variations in solar illumination. Earlier chapters in this report address the technological, economic, and political details inherent in greatly expanding our use of the solar energy resource.

REFERENCES

- ¹Hermann, W.A. “Quantifying Global Energy Resources.” *Energy* 31, no. 12 (2006). 1685-1702. <http://www.sciencedirect.com/science/article/pii/S0360544205001805>
- ²International Energy Outlook 2013. EIA. U.S. Energy Information Administration, DOE/EIA-0484 (July 2013). <http://www.eia.gov/forecasts/ieo/pdf/0484%282013%29.pdf>
- ³Hoffert, M.I., K. Caldeira, A. K. Jain, et al. “Energy Implications of Future Stabilization of Atmospheric CO₂ Content.” *Nature* 395, no. 6705 (1998). 881-884. <http://www.nature.com/nature/journal/v395/n6705/full/395881a0.html>
- ⁴Pachauri, R.K., M. R. Allen, V. R. Barros, et al. *Climate Change 2014: Synthesis Report*. Intergovernmental Panel on Climate Change. (2014). <http://www.ipcc.ch/report/ar5/syr/>
- ⁵Jacobson, M.Z., and M.A. Delucchi. “Providing All Global Energy with Wind, Water, and Solar Power, Part I: Technologies, Energy Resources, Quantities and Areas of Infrastructure, and Materials.” *Energy Policy* 39, no. 3 (2011). 1154-1169. <http://www.sciencedirect.com/science/article/pii/S0301421510008645>
- ⁶Hansen, J., P. Kharecha, M. Sato, et al. “Assessing “Dangerous Climate Change”: Required Reduction of Carbon Emissions to Protect Young People, Future Generations and Nature.” *PloS one* 8, no. 12 (2013). e81648. <http://journals.plos.org/plosone/article?id=10.1371/journal.pone.0081648>
- ⁷Glasstone, S. and P. Dolan. *The Effects of Nuclear Weapons*. U.S. Department of Defense and Energy Research and Development Administration. (1977). <https://www.fourmilab.ch/etexts/www/effects/>
- ⁸Williams, D.R. *Sun Fact Sheet*. National Aeronautics and Space Administration. (2013). <http://nssdc.gsfc.nasa.gov/planetary/factsheet/sunfact.html>
- ⁹*The International System of Units (SI), 8th edition*. Bureau International des Poids et Mesures. (2006). http://www.bipm.org/utis/common/pdf/si_brochure_8_en.pdf
- ¹⁰Fu, Q. “Solar Radiation.” *Encyclopedia of Atmospheric Sciences*. Academic Press. (2002). 1859-1863. <http://dx.doi.org/10.1016/B0-12-227090-8/00334-1>
- ¹¹*Earth Fact Sheet*. National Aeronautics and Space Administration. <http://nssdc.gsfc.nasa.gov/planetary/factsheet/earthfact.html>
- ¹²Fröhlich, C., and J. Lean. “Solar Radiative Output and its Variability: Evidence and Mechanisms.” *The Astronomy and Astrophysics Review* 12, no. 4 (2004). 273-320. <http://link.springer.com/content/pdf/10.1007%2Fs00159-004-0024-1.pdf>
- ¹³*Reference Solar Spectral Irradiance: Air Mass 1.5*. American Society for Testing and Materials (ASTM) Terrestrial Reference Spectra for Photovoltaic Performance Evaluation. ASTM G173-03 Tables <http://rredc.nrel.gov/solar/spectra/am1.5/>
- ¹⁴Kiehl, J.T., and K.E. Trenberth. “Earth’s Annual Global Mean Energy Budget.” *Bulletin of the American Meteorological Society* 78, no. 2 (1997). 197-208. <http://journals.ametsoc.org/doi/abs/10.1175/1520-0477%281997%29078%3C0197:EAGMEB%3E2.0.CO;2>
- ¹⁵*Climate Change 2007: The Physical and Scientific Basis*. Intergovernmental Panel on Climate Change (IPCC). (2007). http://www.ipcc.ch/publications_and_data/publications_ipcc_fourth_assessment_report_wg1_report_the_physical_science_basis.htm
- ¹⁶Jaffe, R.L. and W. Taylor. *The Physics of Energy*. to be published by Cambridge University Press.
- ¹⁷*Measurement and Instrumentation Data Center (MIDC)*. National Renewable Energy Laboratory. <http://www.nrel.gov/midc/>
- ¹⁸*Dynamic Maps, GIS Data, & Analysis Tools – Solar Maps*. National Renewable Energy Laboratory. <http://www.nrel.gov/gis/solar.html>
- ¹⁹Global Horizontal Solar Radiation - Annual. National Renewable Energy Laboratory. (February 17, 2005). <http://en.openei.org/w/index.php?title=File:NREL-solar-glo.pdf>
- ²⁰*OpenStreetMap*. OpenStreetMap. <http://www.openstreetmap.org>
- ²¹Denholm, P., and R. M. Margolis. “Land-use Requirements and the Per-capita Solar Footprint for Photovoltaic Generation in the United States.” *Energy Policy* 36, no. 9 (2008). 3531-3543. <http://dx.doi.org/10.1016/j.enpol.2008.05.035>
- ²²*National Solar Radiation Data Base - 1991-2010 Update*. National Renewable Energy Laboratory. http://rredc.nrel.gov/solar/old_data/nsrdb/1991-2010/hourly/list_by_state.html
- ²³Albuisson, M., M. Lefevre, and L. Wald. *Averaged Solar Radiation 1990-2004*. Ecole des Mines de Paris. (2006). http://www.soda-is.com/img/map_ed_13_world.pdf

- ²⁴Rankin, B. *Radical Cartography*. (2008) www.radicalcartography.net
- ²⁵*Solar Resources By Class and Country*. National Renewable Energy Laboratory. OpenEI. <http://en.openei.org/datasets/dataset/solar-resources-by-class-and-country>
- ²⁶*World DataBank. World Development Indicators*. The World Bank. (December 19, 2014). <http://databank.worldbank.org/data/views/reports/tableview.aspx>
- ²⁷De Vos, A. “Detailed Balance Limit of the Efficiency of Tandem Solar Cells.” *Journal of Physics D: Applied Physics* 13, no. 5 (1980). 839-846. http://iopscience.iop.org/0022-3727/13/5/018/pdf/0022-3727_13_5_018.pdf
- ²⁸Shockley, W. and H. J. Queisser, “Detailed Balance Limit of Efficiency of p-n Junction Solar Cells.” *J. Appl. Phys.*, vol. 32, no. 3 (1961). 510-519. <http://dx.doi.org/10.1063/1.1736034>
- ²⁹Hanna, M.C. and A.J. Nozik. “Solar Conversion Efficiency of Photovoltaic and Photoelectrolysis Cells with Carrier Multiplication Absorbers.” *Journal of Applied Physics* 100, no. 7 (2006). 074510. <http://scitation.aip.org/content/aip/journal/jap/100/7/10.1063/1.2356795>
- ³⁰Lunt, R.R., T.P. Osedach, P.R. Brown, J.A. Rowehl, and V. Bulović. “Practical Roadmap and Limits to Nanostructured Photovoltaics.” *Advanced Materials* 23, no. 48 (2011). 5712-5727. <http://onlinelibrary.wiley.com/doi/10.1002/adma.201103404/full>
- ³¹*Best Research-Cell Efficiencies, 2014*. National Renewable Energy Laboratory. http://www.nrel.gov/ncpv/images/efficiency_chart.jpg
- ³²Metz, A., M. Fischer, G. Xing, et al. *International Technology Roadmap for Photovoltaic (ITRPV) 2013 Results*. ITRPV. (2014). <http://www.itrpv.net/Reports/Downloads/2014/>
- ³³*PVWatts Calculator*. National Renewable Energy Laboratory. http://pvwatts.nrel.gov/version_5.php
- ³⁴Fthenakis, V., and H. C. Kim. “Land Use and Electricity Generation: A Life-cycle Analysis.” *Renewable and Sustainable Energy Reviews* 13, no. 6 (2009). 1465-1474. <http://www.sciencedirect.com/science/article/pii/S1364032108001354>
- ³⁵*Solar Summaries*. National Renewable Energy Laboratory. <http://www.nrel.gov/gis/docs/SolarSummaries.xlsx>
- ³⁶*Energy Technology Perspectives 2014 – Harnessing Electricity’s Potential*. International Energy Agency. (2014). <http://www.iea.org/etp/etp2014/>
- ³⁷*X-Series Solar Panels*. Sunpower. <http://us.sunpower.com/solar-panels-technology/x-series-solar-panels/>
- ³⁸*White Sands Missile Range Fact Sheet*. National Aeronautics and Space Administration. http://www.nasa.gov/pdf/449089main_White_Sands_Missile_Range_Fact_Sheet.pdf
- ³⁹*Dugway Proving Ground Facts & Figures*. United States Army. <http://www.dugway.army.mil/Facts.aspx>
- ⁴⁰Mehos, M.S. and D. W. Kearney. “Potential Carbon Emissions Reductions from Concentrating Solar Power by 2030.” in *Tackling Climate Change in the United States*, C. F. Kutscher, Ed. American Solar Energy Society (January 2, 2007). 79–89. <http://www.ases.org/2007/01/tackling-climate-change/>
- ⁴¹*National Renewable Energy Laboratory - Renewable Energy Atlas*. National Renewable Energy Laboratory. maps.nrel.gov/re_atlas

The hyperlinks in this document were active as of April 2015.

Appendix B – Photovoltaics Primer

B.1 INTRODUCTION

This appendix describes, in simple terms, the principles that govern the conversion of light into electric power within photovoltaic (PV) devices. We begin by describing the fundamentals of energy conversion, light, and electric power. We next introduce the concept of semiconductors and discuss the electric and optical properties that govern their interaction with light. We explain the concept of the diode as the fundamental functional unit of a PV device and review the characterization and standard performance metrics of solar cells. Finally, we explain how solar cells are combined to form PV modules and arrays.ⁱ

B.2 ENERGY AND POWER

Energy can be defined as the capacity of a system to perform work.ⁱⁱ In the International System of Units, the unit of measure for energy is the *joule*, where one joule represents roughly the amount of energy required to lift a can of soda one foot off the ground.ⁱⁱⁱ *Power* is the rate of flow of energy per unit time and is measured in units of *watts*, where one watt is equal to an energy flow of one joule per second. Energy can thus be expressed equivalently in terms of power times time in units of *watt-hours* or, more commonly in the electric power sector, *kilowatt-*, *megawatt-*, *gigawatt-*, or *terawatt-hours*, where the prefixes kilo-, mega-, giga-, and tera- denote

multiplication factors of one thousand, one million, one billion, and one trillion, respectively.

A typical home in the United States utilizes electric power at an average rate of roughly 1.3 kilowatts, corresponding to an energy usage of approximately 30 kilowatt-hours per day.⁸

Energy cannot be created or destroyed, but it can be stored and converted between different forms.^{iv} There are many different forms of energy: the chemical energy stored within the carbon-to-carbon bonds in a piece of coal, the gravitational potential energy of the elevated water in a dammed reservoir, and the radiant energy continually delivered to the earth's surface by the sun are all familiar examples. What are typically thought of as energy *generation* devices — coal-fired power plants, hydroelectric dams, or solar panels — are thus actually energy *conversion* devices.

Figure B.1 summarizes, in a simplified format, the forms of energy and energy conversion processes that are relevant to the generation of electric power. Note that the only continuous input of energy to the earth is the radiant energy of the sun. Each energy conversion process, denoted by labeled arrows in Figure B.1, involves the irreversible conversion of some portion of the energy input to low-grade thermal energy (i.e., waste heat). In this context, **the efficiency of an energy conversion process is the ratio of usable energy output at the end of the conversion process to the energy input**; low-grade

ⁱFor a more complete explanation of the physical concepts described in this appendix, we point the interested reader to several relevant textbooks.^{1,2,3,4,5,6} Portions of this appendix are reproduced from a recent publication by members of this study group.⁷

ⁱⁱWe here refer to *work* in the sense in which it is used in physics — that is, as a measure of the force applied on a point in motion over a displacement in location, for the component of the force that is in the direction of that motion.

ⁱⁱⁱMuch more energy is contained within the can of soda; one joule is roughly the amount of extractable dietary energy contained in one-hundredth of a drop of (non-diet) soda.

^{iv}Einstein's famous " $E=mc^2$ " equation implies that mass and energy are equivalent properties and represent the same physical quantity, not that energy can be "created" from matter.

Figure B.1 Forms of Energy and Energy Conversion Processes

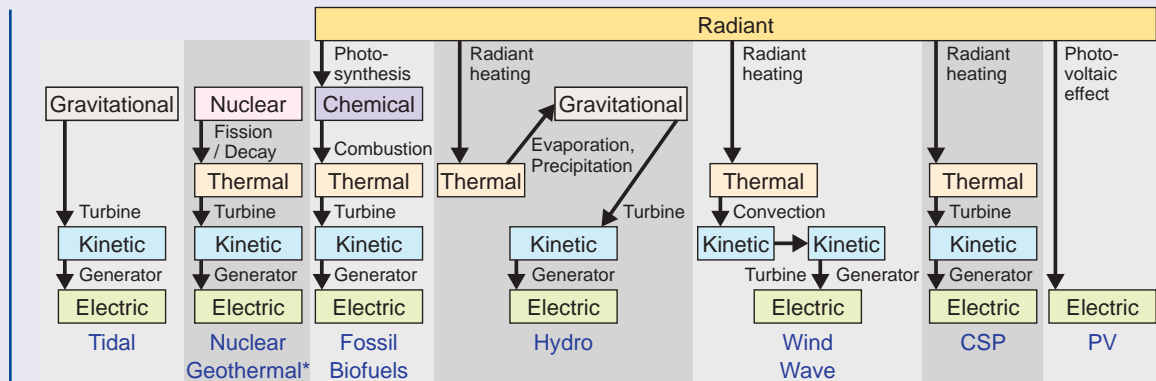

Note: Figure B.1 shows relevant forms of energy (colored boxes) and energy conversion processes (labeled arrows) for the production of electric power. Note that gravitational, nuclear, and chemical energy all represent energy that can be stored for long periods of time with high efficiency; direct storage of thermal, kinetic, or electric energy is much less efficient. Radiant energy from the sun is the only external energy input to the earth system.

*The flow of geothermal energy from the earth’s interior to its surface results in roughly equal measure from leftover energy still being dissipated from the earth’s formation and from the nuclear decay of radioactive isotopes in the earth’s interior.⁹

waste heat primarily accounts for the “missing” energy in an inefficient process. Some conversion processes are more efficient than others: for example, electric generators can convert the kinetic energy of a spinning turbine to electric energy with efficiencies greater than 90%, but only about 30%–40% of the thermal energy released when coal is burned can be extracted as kinetic energy. Photovoltaics are unique in their ability to directly convert solar energy to electric energy; by eliminating the relatively inefficient processes of photosynthesis (0.5%–2% efficient)¹⁰ and thermal-to-kinetic-energy conversion, **photovoltaics represent the most direct and efficient use of the earth’s primary energy input — sunlight.**

We next describe the properties of light (radiant power; the input to PV devices) and electricity (electric power; the output from PV devices).

B.3 LIGHT

Light typically refers to a specific type of *electromagnetic radiation* that is visible to the human eye. Electromagnetic radiation is comprised of oscillating electric and magnetic fields that vibrate with a given *frequency* and *wavelength* and propagate in a straight line. Figure B.2 provides a graphic representation of the electromagnetic spectrum. Visible light is typically characterized as electromagnetic radiation with a wavelength between approximately 400 and 750 nanometers;^v as shown in the figure, humans perceive light of different wavelengths as different colors. Visible light occupies a small fraction of a spectrum of wavelengths that spans many orders of magnitude, from gamma rays and X-rays, through ultraviolet, visible, and infrared radiation, to microwaves and radio waves.

^vOne nanometer is one billionth (10⁻⁹) of a meter; a human hair is roughly 75,000 nanometers in diameter.¹¹

The fundamental quantized unit (or quantum) of light is the *photon*, which represents the smallest isolable packet of electromagnetic radiation of a given wavelength. The energy content of a photon is proportional to its frequency and inversely proportional to its wavelength, and the power delivered by a light source to an absorbing surface is equal to the flux, or rate of flow, of photons absorbed by that surface times the energy of each incident photon. As shown in Appendix A, Figure A.2a,

the sun’s emission spectrum stretches from the ultraviolet through the infrared. **The power delivered by solar radiation to a surface pointing toward the sun, located at the earth’s surface at noon, on a cloudless day and at a latitude representative of many of the world’s major population centers, is roughly one kilowatt per square meter.** The nature of sunlight and its interaction with the earth and its atmosphere is described in more detail in Appendix A.

Figure B.2 The Electromagnetic Spectrum

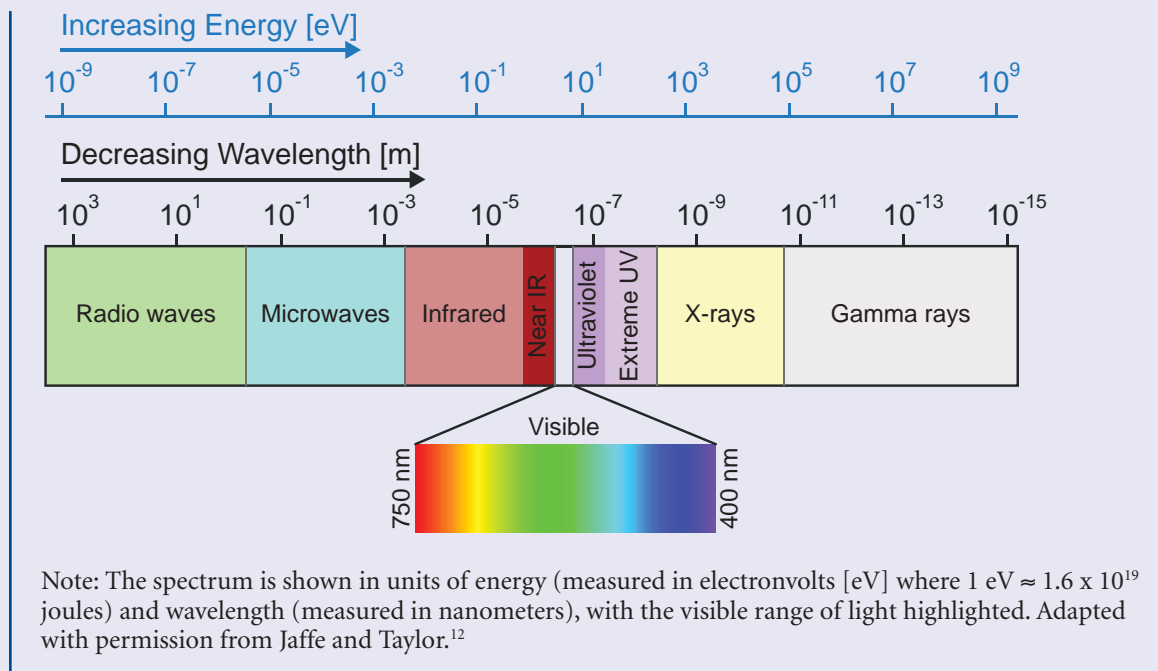

Equation B.1 Photon Energy

The energy of a photon is given by

$$E = \frac{hc}{\lambda} = h\nu,$$

where E is the photon energy, h is Planck’s constant (equal to $\sim 6.6 \times 10^{-34}$ joule-seconds), c is the speed of light (equal to $\sim 3.0 \times 10^8$ meters per second), λ is the photon wavelength, and ν is the photon frequency.

B.4 ELECTRICITY AND ELECTRIC POWER

Electricity is characterized by *voltage* and *current*. Current, measured in *amps*, corresponds to the rate of flow of charge; if we imagine electricity flowing through a wire as analogous to water flowing through a pipe, current is the rate of flow of the water. Voltage, measured in *volts*, corresponds to the electric potential energy difference, per unit charge, between two points. In our analogy of water flow, the voltage between two points corresponds to the pressure or height differential between those points; it is the driving force behind the flow. The electrical *resistance* of a sample of material is the ratio between the voltage applied to the sample and the current that flows through it; in our water flow analogy, the resistance would be inversely proportional to the diameter of the pipe through which the water flows. Electric power is equal to the product of voltage and current.

We now describe the properties of charge carriers within electronic materials and explain how these materials may be utilized to fabricate solar cells.

B.5 ELECTRONIC MATERIALS

A typical solid such as silicon contains roughly 700 billion billion (7×10^{20}) electrons per cubic millimeter of material, where an *electron* is a subatomic particle with an electric charge, by definition, of $-1 e$.^{vi} Electrons occupy states of well-defined energy within a solid; much like water filling up a bucket, electrons minimize their energy by filling up the lowest-energy states (the deepest part of the bucket, or the most tightly-bound atomic energy states) first. Electrons are one of two types of charge carriers within a typical solid; the other type of charge carrier is the *hole*, which is simply the absence of an electron in a position where an electron would normally be found. If electrons are compared to drops of water, holes can be compared to bubbles below the water's surface. By carrying an absence of negative charge within a surrounding sea of negatively charged electrons,^{vii} a hole can be treated as a carrier of positive charge, moving in the opposite direction from an electron under an applied electric field. The *electrical conductivity* of a material is proportional to the density (the number per unit volume) of mobile electrons and holes

Equation B.2 Ohm's Law

The relationship between current, voltage, and resistance is given by Ohm's Law:

$$V = IR,$$

where V is voltage (measured in volts [V]), I is current (measured in amps [A]), and R is resistance (measured in ohms [Ω]).

^{vi}A charge of “1 e” is equivalent to approximately 1.6×10^{-19} amp-seconds; it is the amount of charge that flows past a point when a current of 1 amp is allowed to flow through that point for approximately 1.6×10^{-19} seconds. An *electronvolt*, eV, is defined as the energy gained or lost by an electron as it passes through a voltage difference of 1 volt. One eV is equal to approximately 1.6×10^{-19} joules.

^{vii}The negative charge of each electron is balanced by a positive charge in the nucleus of the atom from which the electron originates, such that the entire solid carries no net charge.

Equation B.3 Electrical Conductivity

The electrical conductivity σ of a material is given by

$$\sigma = \sigma_e + \sigma_h = q(n\mu_e + p\mu_h),$$

where σ_e and σ_h are the electron and hole conductivities, respectively; q is the charge of the electron; n and p are, respectively, the electron and hole densities; and μ_e and μ_h are, respectively, the electron and hole mobilities.

multiplied by the *mobility* (the ratio of a charge carrier's velocity to the magnitude of the electric field that drives its motion) of these charge carriers within the material.

Electrons can be *excited* by the absorption of external energy in the form of photons or heat. A single excitation generates both an electron and hole; the excited electron, in its transition to a higher-energy state, leaves behind an empty hole in its previous state. In a typical solid at room temperature, heat is primarily manifested as minute vibrations in the atoms that make up the solid. For electrons, this heat has the effect of a continuous spectrum of low-energy excitations, inducing small ripples on the surface of the energetic sea of electrons.

As with vibrational modes on a vibrating guitar string, only certain electron energies are physically allowed within a material. In a single atom or molecule these energies exist as discrete, isolated energy states; in extended solids with large numbers of atoms these discrete states are smeared out into broad *energy bands*. In pure materials, electrons can only reside at energies contained within these bands; they cannot occupy energies between bands, where there are no electronic states.

The electronic properties of a given material are determined to a large extent by the profile of these energy bands and the extent to which they are filled with electrons.

The highest-energy band that is completely filled with electrons is called the *valence band*; the next-higher band is called the *conduction band*.

As shown in Figure B.3, the three major classes of electronic materials — *metals*, *insulators*, and *semiconductors* — are characterized by distinct energy band arrangements. Metals contain an incompletely filled energy band, allowing the collective motion of electrons at the energetic surface of the filled states (much like waves in a partially-filled container of water). *Insulators* contain completely filled bands separated by a large *bandgap*. This bandgap in insulators is too wide to allow significant excitation of electrons across the gap by heat or visible photons. Since in most situations the valence band of insulators is filled with electrons (with no mobile holes) and the conduction band is empty of electrons, no charge carriers are available to flow under an applied electric field, making these materials electrically resistive.

Semiconductors are intermediate between metals and insulators; they exhibit a bandgap between filled and empty bands, but the gap is small enough for electrons to be excited across it by heat or visible photons. Semiconductors can also be *doped* with minute quantities of impurity atoms that can easily donate excess electrons or holes to the rest of the solid, thereby increasing the density of free charge carriers and the conductivity of the semiconductor.

Figure B.3 Energy Band Structure of Metals, Semiconductors, and Insulators

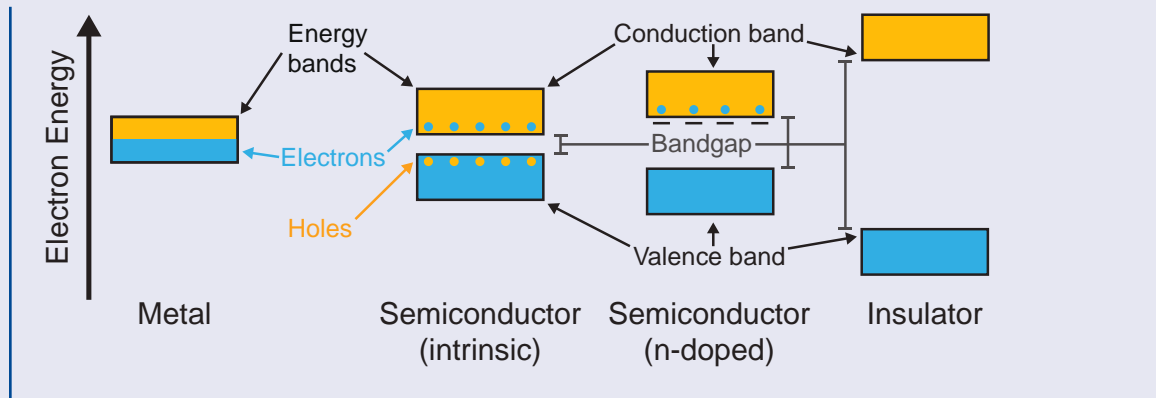

Table B.1 Bandgaps of Various Materials

Material	Bandgap [eV]
Metals	0
PbS (lead sulfide)	0.4
Si (silicon)	1.1
CdTe (cadmium telluride)	1.4
CIGS (copper indium gallium diselenide)	1.0–1.7
C (diamond)	5.5
SiO ₂ (silica glass)	~9
LiF (lithium fluoride)	13.6

Note: Common solar cell materials are highlighted in orange; insulators are highlighted in green.^{1,2,13,14,15}

B.6 PN-JUNCTION DIODES AND SOLAR CELLS

The fundamental functional unit of a solar cell is a *pn-junction diode*, which forms at the interface between two semiconductors, where one semiconductor is doped with an excess of electron-donating impurities (an *n-type* semiconductor, so named for the excess of free negatively-charged electrons) and the other semiconductor is doped with an excess of hole-donating impurities (a *p-type* semiconductor, so named for the excess of free positively-charged holes). Figure B.4 illustrates the fundamentals of the pn-junction diode.

When an n-type and p-type material are put in contact, free electrons from the n-type side and free holes from the p-type side will diffuse across the interface, cancelling each other out (the electrons “fill in” the holes). This “cancelling out” of the free carriers in the region of the interface uncovers the fixed charges of the dopants that originally balanced the charge of the free electrons and holes, generating a built-in electric field in the interface region that prevents further diffusion. This field corresponds to a built-in voltage gradient between the n-type and p-type sides of the junction.

Figure B.4 Physical Structure and Electric Properties of a pn-Junction Diode

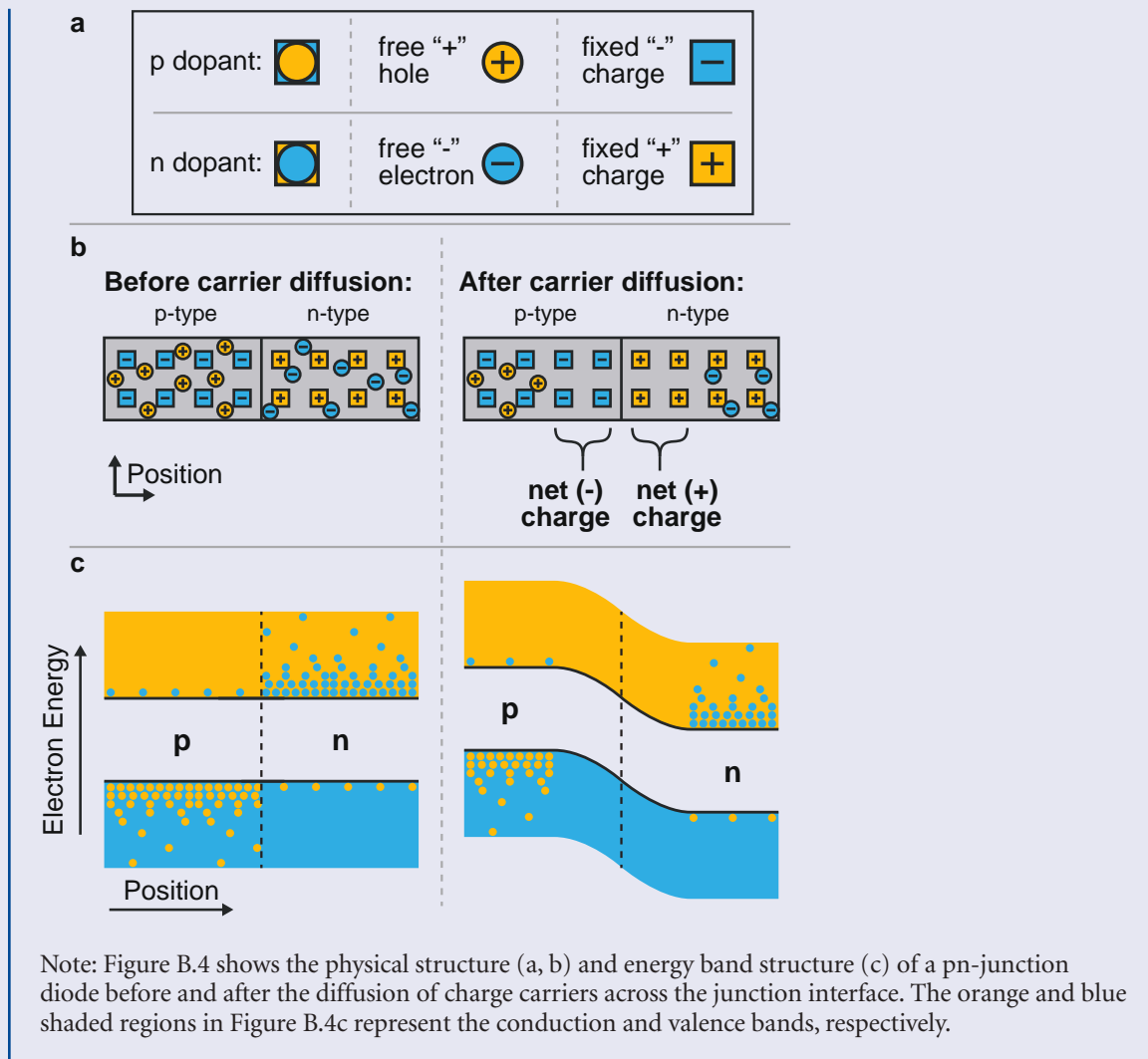

The diode acts as a one-way valve for charge carriers, as shown in Figure B.5. If a positive voltage is applied to the p-type side of the junction (the left side of the junction as shown here) relative to the n-type side, the built-in field is reduced, and large numbers of carriers can diffuse across the interface, generating a large current. If a negative voltage is applied to the p-type side relative to the n-type side, the built-in field is strengthened, and diffusion remains unfavorable. The curve labeled “dark” in Figure B.6a shows the current passed through a representative diode at different applied voltage levels; this current increases

exponentially under positive voltage, but remains small under negative voltage.

A solar cell is simply a diode that can generate free electrons and holes through the absorption of light, as depicted in Figure B.7a. These free charge carriers are separated under the built-in electric field of the diode, generating photocurrent; the generation of photocurrent is roughly independent of the voltage across the solar cell, so the “light” curve in Figure B.6a is vertically offset by a constant amount from the “dark” curve. The current is correlated with the number of carriers generated, which in turn

Figure B.5 Energy Bands during Operation of a pn-Junction Diode

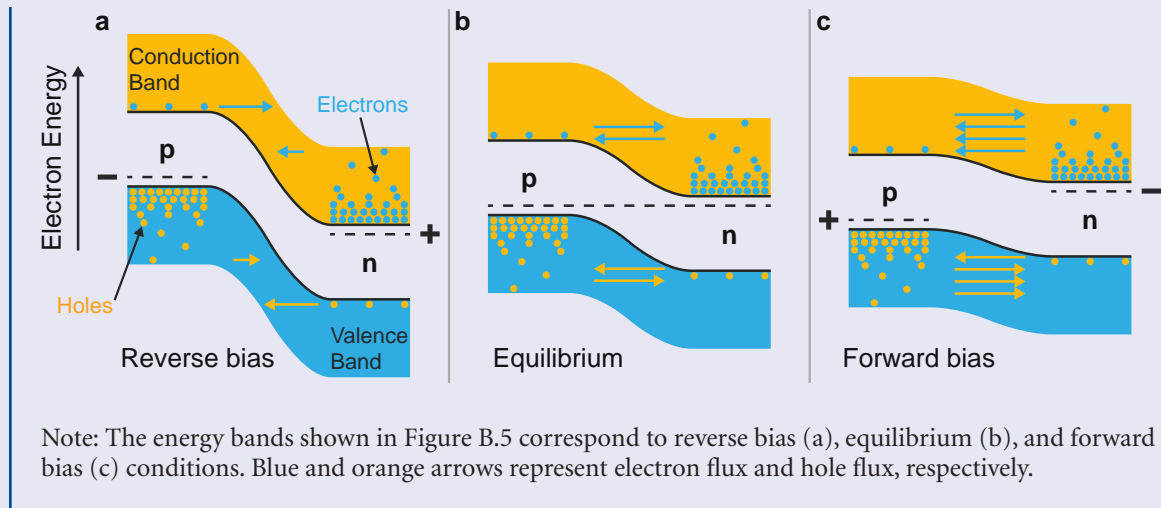
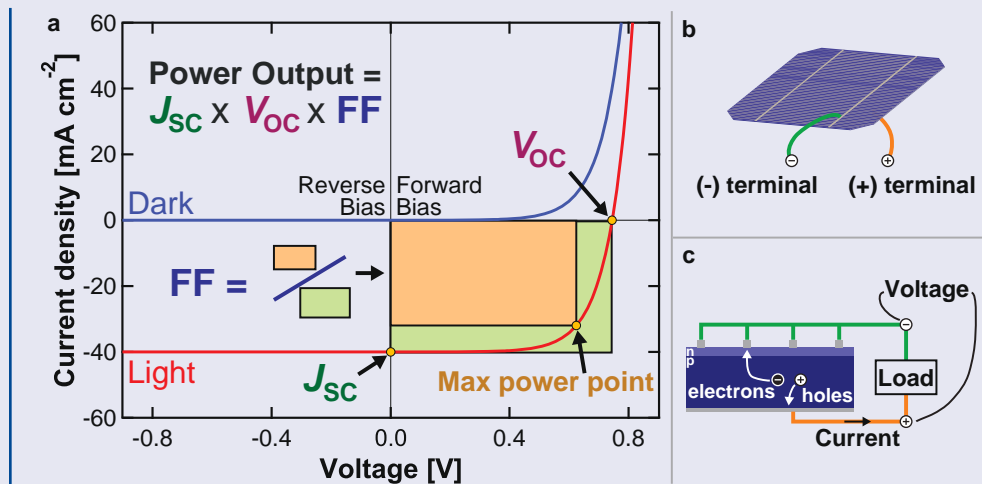

Figure B.6 Representative Current–Voltage Characteristics of a Solar Cell



Note: Figure B.6a shows solar cell current–voltage characteristics in the dark (blue curve) and under illumination (red curve). The short-circuit current density (J_{sc}), open-circuit voltage (V_{oc}), and fill factor (FF) are indicated; the physical significance of these metrics is described in the text. The current output of an illuminated solar cell is proportional to its illuminated surface area, so current output is typically reported as *current density* (current divided by area) to normalize for different solar cell sizes. Voltage and current are measured between the positive and negative terminals of the solar cell (Figures B.6b, B.6c).

depends on the absorption properties of the semiconductor and its efficiency in turning absorbed photons into extractable charge carriers (this efficiency, known as the *external quantum efficiency*, is described in more detail below). The voltage is correlated with the strength of the built-in electric field of the diode.

Figure B.6 illustrates the current–voltage output of a representative solar cell, both in the dark (blue curve, acting as a simple diode) and under illumination (red curve), and identifies key operational parameters. The *open-circuit voltage* (V_{OC}) is the voltage measured between the two terminals of an illuminated solar cell when the terminals are left “open” (i.e., not connected to each other by a conductive path) and no current is allowed to flow. The *short-circuit current density* (J_{SC}) is the current density that flows through the solar cell when the two terminals are “shorted” together by a highly conductive pathway (like a copper wire) and held at the same voltage.

The voltage output of an operating solar cell will range between zero and the value of its V_{OC} ; the current output stays roughly constant over much of this range, until the voltage approaches the V_{OC} . The power output at a given voltage is equal to the product of the voltage and the current at that voltage and will reach a maximum near the apparent “shoulder” in the current–voltage curve (as depicted by the orange rectangle in Figure B.6). The *fill factor* of a solar cell, which corresponds to the perceived “squareness” of its illuminated current–voltage curve, is the ratio between its power output at the *maximum power point* and the product of its J_{SC} and V_{OC} . **The power conversion efficiency of a solar cell is equal to the product of the J_{SC} , V_{OC} , and fill factor, divided by the intensity of the incident light** (usually measured under standard illumination conditions of one kilowatt per square meter, as discussed above).

Figure B.7 Operation of a Solar Cell under Illumination and Interaction of Light with a Light-Absorbing Semiconductor

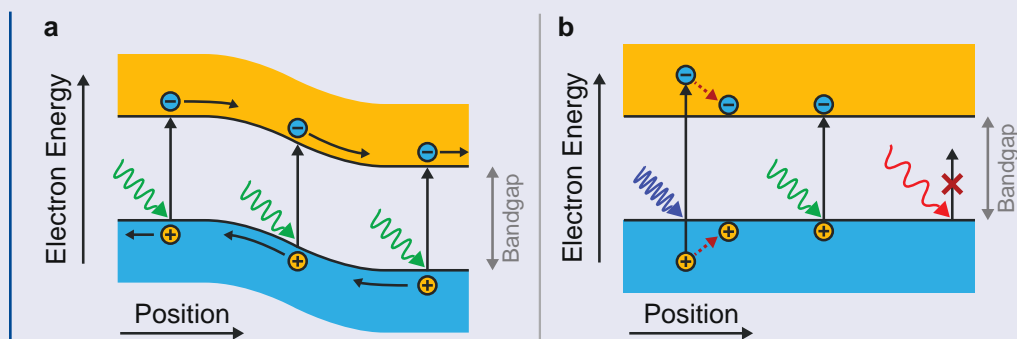

Note: Figure B.7a shows excitation of electrons and holes by photons in a solar cell, followed by charge carrier separation under the built-in electric field. The conduction band and holes are shown in orange; the valence band and electrons are shown in blue. Figure B.7b shows the interaction of light of various wavelengths with a light-absorbing semiconductor. Short-wavelength photons of energy higher than the bandgap (here depicted as blue wavy lines) generate excited electron–hole pairs with net energy greater than the bandgap, but the electron and hole quickly lose their excess energy and “relax” to the bottom of the conduction band (for electrons) and top of the valence band (for holes). Long-wavelength photons of energy lower than the bandgap (here depicted as red wavy lines) are not absorbed and do not generate free electron-hole pairs.

Equation B.4 Current–Voltage Characteristics of a Solar Cell

The current density output from a solar cell, J_{PV} , as a function of voltage is given by

$$J_{PV} = J_0 \left(e^{\frac{qV}{k_B T}} - 1 \right) - J_{SC},$$

where J_0 is the reverse saturation current density, q is the charge of the electron, V is the voltage applied to the solar cell, k_B is the Boltzmann constant (equal to $\sim 1.4 \times 10^{-23}$ joules per kelvin), T is the temperature (measured in kelvin), and J_{SC} is the short-circuit current density. With J_{SC} set to zero, this equation represents the current output of a simple diode.

B.7 SOLAR CELL EFFICIENCY

The current and voltage output of a solar cell cannot be simultaneously maximized. Since a solar cell can only absorb photons with energy greater than the bandgap, reducing the bandgap will lead to larger currents. However, as depicted in Figure B.7b, electrons excited by photons with energy greater than the bandgap quickly dissipate their excess energy as wasted heat, ultimately coming to rest at an energy equal to the bandgap. The bandgap energy is thus the maximum energy that can be extracted as electrical energy from each photon absorbed by the solar cell. Reducing the bandgap will lead to smaller voltages, eventually counteracting the benefit of increasing the current. The broad emission spectrum of the sun thus limits our ability to harvest both the maximum number of photons and the maximum energy from each photon. **The theoretical maximum power conversion efficiency of a single-junction solar cell, under unconcentrated solar illumination and room-temperature operation, is roughly 33%, a quantity known as the Shockley-Queisser Limit.**^{16, 17} This limit can be surpassed by *multijunction* solar cells that use a combination of materials of different bandgaps; these devices enable a greater

fraction of the energy of each absorbed photon to be extracted as voltage and have a maximum theoretical efficiency of roughly 68% under unconcentrated sunlight.¹⁸ In an actual solar cell, the presence of defects and parasitic resistive losses will decrease the efficiency to values below these limits.

As mentioned above, the *external quantum efficiency* (EQE) of a solar cell is the efficiency with which individual photons of a given wavelength are converted to extracted charge carriers. Figure B.8 shows the EQE spectra of world-record solar cells of various types, compared with the solar spectrum observed at the earth's surface. Sharp cutoffs in EQE are observed on the high-wavelength (low-energy) side of each spectrum at the bandgap of the absorbing material, as photons with energy less than the bandgap cannot be absorbed. The multiplicative product of the EQE spectrum and the solar spectrum, integrated over all wavelengths, should give the J_{SC} produced by the solar cell. Many loss processes can reduce the EQE to levels below 100%, including reflection of light from the surface of the solar cell, absorption of light by non-current-generating materials within the solar cell, or loss of current due to parasitic resistances.

B.8 SOLAR CELL FABRICATION

A solar cell is typically fabricated by one of two general methods: **modification of a bulk wafer or additive deposition of thin films onto a substrate.** The first approach, wafer modification, is used for conventional crystalline silicon cells and III-V multijunction cells (these technologies are described in more detail in Chapter 2). In this method, an extremely pure wafer of semiconductor is used as the starting material and dopants are introduced near the surface to create a pn junction. The wafer serves as both light absorber and substrate; charge carriers are generated within the wafer and extracted directly from the front (top) and back (bottom) faces of the wafer by electrical

contacts. The second approach, additive deposition, is used to make most thin-film solar cells. Here a separate substrate — a sheet of glass, plastic, or metal, which can either be rigid or flexible — serves as a mechanical support for the active cell. Light-absorbing films and electrical contacts are formed in a layer-by-layer process on the substrate using vapor- or solution-based deposition techniques such as thermal evaporation, chemical vapor deposition, spray coating, or screen printing. Different materials can be individually optimized for light absorption and charge transport, and additional layers are often introduced to enhance charge extraction.

Figure B.8 Solar Photon Flux at the Earth’s Surface and Normalized EQE Spectra for Different Types of Solar Cells ^{19, 20, 21, 22, 23, 24}

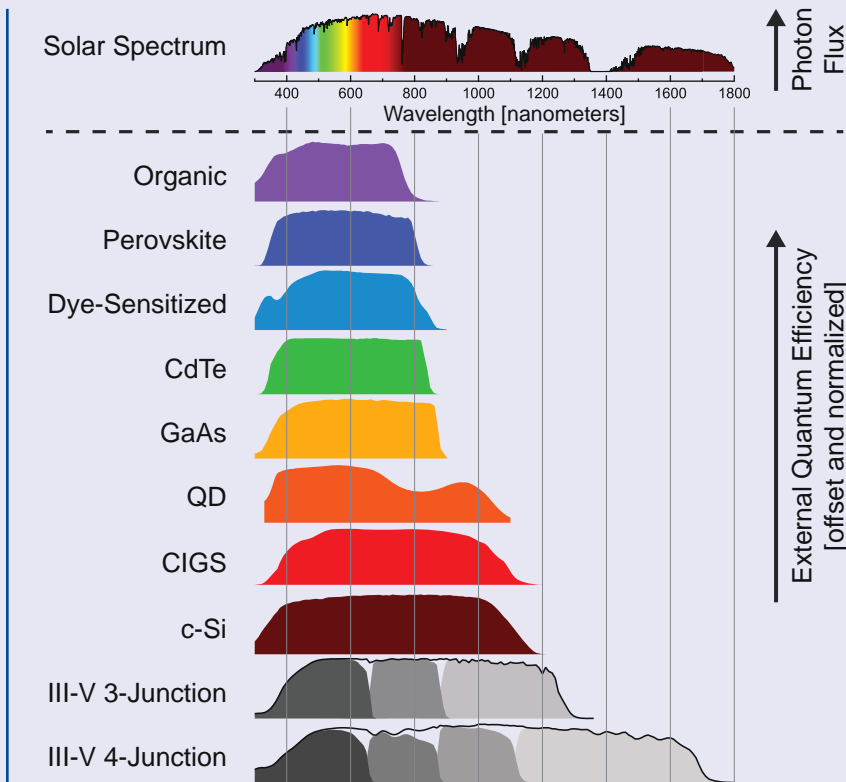

Note: The top part of the figure shows solar photon flux at the earth’s surface as a function of wavelength. The types of solar cell technologies included in the bottom part of the figure are described in more detail in Chapter 2.

B.9 SOLAR CELL ARRAYS

A single 6-inch-by-6-inch silicon solar cell generates a voltage of approximately 0.5–0.6 volts and a power output of approximately 4–5 watts under illumination with direct sunlight at an intensity of one kilowatt per square meter. As shown in Figure B.9, individual cells are connected in *series* in a PV *module* to increase their collective voltage output. A typical module may contain 60 to 96 individual cells, generating a voltage of 30–48 volts and a power output of 260–320 watts. As described in Chapter 2, PV modules also incorporate materials for mechanical support and encapsulation. These modules may then be connected in series to further increase their collective output voltage, or in *parallel* to increase their collective output current; such a collection of solar modules is often called a solar *array*. As described in Chapter 4, additional

balance-of-system (BOS) components such as inverters and transformers are necessary to convert the *direct current* (dc) output of a solar array into *alternating current* (ac) for incorporation into an electric grid; for off-grid applications, the dc output of a solar array may be utilized directly, or batteries and charge controllers may be incorporated to store the energy generated for later use. As described in Appendix A, solar arrays can be stationary or can utilize *solar tracking*, in which the solar panels are rotated through the course of the day to point toward the sun, thereby increasing the power output per panel. Some solar arrays — particularly those that utilize multijunction solar cells — use mirrors or lenses to concentrate sunlight onto the solar cells. Concentrating systems allow smaller solar cells to be used, but typically require accurate solar tracking to keep the concentrated sunlight focused on the cells.

Figure B.9 Schematic Representation of a Solar Cell, a Solar Module, and a Solar Array

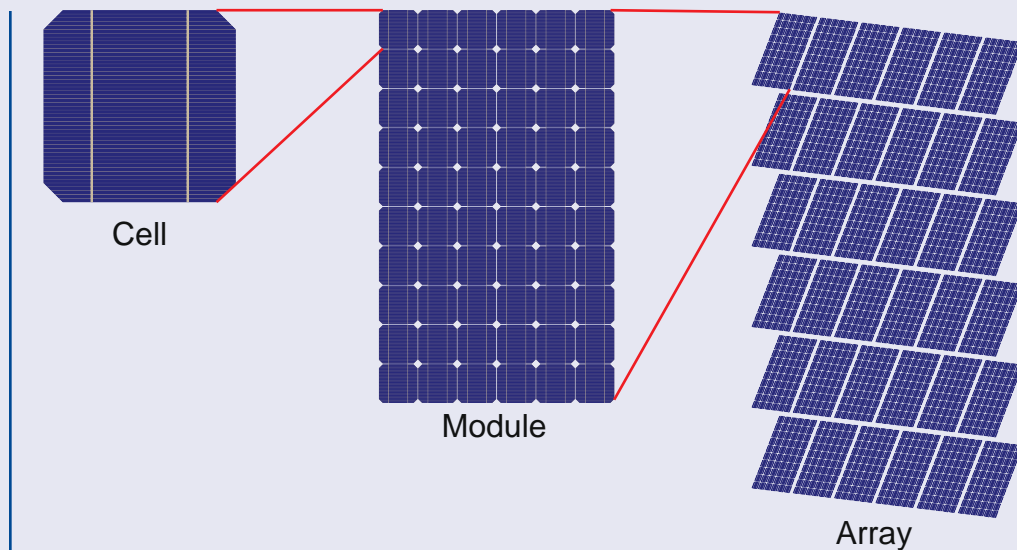

Note: The module incorporates multiple cells, while the array incorporates multiple modules. Balance-of-system components such as racking, wiring, inverters, and transformers are not shown.

REFERENCES

- ¹Kittel, C. *Introduction to Solid State Physics*; 8th ed. John Wiley & Sons. (2005).
- ²Anderson, B.L. and R.L. Anderson. *Fundamentals of Semiconductor Devices*. McGraw-Hill. (2005).
- ³Halliday, D. R. Resnick and K.S. Krane. *Physics*; Volume 1, 5th ed. John Wiley & Sons. (2002).
- ⁴Griffiths, D. J. *Introduction to Electrodynamics*; 3rd ed. Prentice-Hall. (1999).
- ⁵Ashcroft, N.W. and N.D. Mermin. *Solid State Physics*, 1st ed. Brooks/Cole. (1976).
- ⁶Nelson, J. *The Physics of Solar Cells (Properties of Semiconductor Materials)*. Imperial College Press. (2003).
- ⁷Jean, J., P.R. Brown, R.L. Jaffe, T. Buonassisi, and V. Bulovic. "Pathways for Solar Photovoltaics." *Energy & Environmental Science* (2015). <http://dx.doi.org/10.1039/C4EE04073B>
- ⁸How Much Electricity Does an American Home Use? U.S. Energy Information Administration. (Feb 20, 2015). <http://www.eia.gov/tools/faqs/faq.cfm?id=97&t=3>
- ⁹Lay, T., J. Hernelund, and B.A. Buffett. "Core-mantle Boundary Heat Flow." *Nature Geoscience* 1, no. 1 (2008): 25-32. <http://dx.doi.org/10.1038/ngeo.2007.44>
- ¹⁰MacKay, D.J.C. *Sustainable Energy - Without the Hot Air*. UIT Cambridge. (2009). <http://www.inference.eng.cam.ac.uk/sustainable/book/text/sewtha.pdf>
- ¹¹Smith, Graham T. *Industrial metrology: surfaces and roundness*. Springer Science & Business Media. (2002). p. 253.
- ¹²Jaffe, R.L. and W. Taylor. *The Physics of Energy*. To be published by Cambridge University Press.
- ¹³Wei, S. H., and A. Zunger. "Band Offsets and Optical Bowings of Chalcopyrites and Zn based II VI alloys." *Journal of Applied Physics* 78, no. 6 (1995): 3846-3856. <http://dx.doi.org/10.1063/1.359901>
- ¹⁴Clark, C.D., P.J. Dean, and P.V. Harris. "Intrinsic Edge Absorption in Diamond." *Proceedings of the Royal Society of London. Series A. Mathematical and Physical Sciences* 277, no. 1370 (1964): 312-329. <http://dx.doi.org/10.1098/rspa.1964.0025>
- ¹⁵Roessler, D.M., and W.C. Walker. "Electronic Spectrum of Crystalline Lithium Fluoride." *Journal of Physics and Chemistry of Solids* 28, no. 8 (1967): 1507-1515. [http://dx.doi.org/10.1016/0022-3697\(67\)90280-6](http://dx.doi.org/10.1016/0022-3697(67)90280-6)
- ¹⁶Shockley, W. and H.J. Queisser. "Detailed Balance Limit of Efficiency of p-n Junction Solar Cells." *Journal of Applied Physics* 32, no. 3 (1961): 510-519. <http://dx.doi.org/10.1063/1.1736034>
- ¹⁷Hanna, M.C., and A.J. Nozik. "Solar Conversion Efficiency of Photovoltaic and Photoelectrolysis Cells with Carrier Multiplication Absorbers." *Journal of Applied Physics* 100, no. 7 (2006): 074510. <http://dx.doi.org/10.1063/1.2356795>
- ¹⁸De Vos, A. "Detailed Balance Limit of the Efficiency of Tandem Solar Cells." *Journal of Physics D: Applied Physics* 13, no. 5 (1980): 839-846. <http://dx.doi.org/10.1088/0022-3727/13/5/018>
- ¹⁹Green, M.A., K. Emery, Y. Hishikawa, W. Warta, and E.D. Dunlop. "Solar Cell Efficiency Tables (Version 39)." *Progress in Photovoltaics: Research and Applications* 20, (2012): 12-20. <http://dx.doi.org/10.1002/pip.2163>
- ²⁰Green, M.A., K. Emery, Y. Hishikawa, W. Warta, and E.D. Dunlop. "Solar Cell Efficiency Tables (Version 40)." *Progress in Photovoltaics: Research and Applications* 20, (2012): 606-614. <http://dx.doi.org/10.1002/pip.2267>
- ²¹Green, M.A., K. Emery, Y. Hishikawa, W. Warta, and E.D. Dunlop. "Solar Cell Efficiency Tables (Version 41)." *Progress in Photovoltaics: Research and Applications* 21, (2013): 1-11. <http://dx.doi.org/10.1002/pip.2352>
- ²²Green, M.A., K. Emery, Y. Hishikawa, W. Warta, and E.D. Dunlop. "Solar Cell Efficiency Tables (Version 42)." *Progress in Photovoltaics: Research and Applications* 21, (2013): 827-837. <http://onlinelibrary.wiley.com/doi/10.1002/pip.2404/abstract>
- ²³Chuang, C.-H. M., P.R. Brown, V. Bulovic, and M.G. Bawendi. "Improved Performance and Stability in Quantum Dot Solar Cells Through Band Alignment Engineering." *Nature Materials* 13, no. 8 (2014): 796-801. <http://dx.doi.org/10.1038/nmat3984>
- ²⁴Green, M.A., K. Emery, Y. Hishikawa, W. Warta, and E.D. Dunlop. "Solar Cell Efficiency Tables (Version 45)." *Progress in Photovoltaics: Research and Applications* 23, (2015): 1-9. <http://dx.doi.org/10.1002/pip.2573>

The hyperlinks in this document were active as of April 2015.



Appendix C – Energy Storage Systems for the Electric Power Sector

C.1 INTRODUCTION

Demand for stationary energy storage systems (ESSs) is forecast to grow significantly in the coming years. This is being driven in large part by the ability of ESSs to facilitate integration of renewable, non-dispatchable energy sources, such as solar and wind, on the electric grid. Adoption of ESSs may also be enhanced by the range of services they can provide, including deferral of infrastructure investments, grid stabilization, and resiliency through backup power (see Section C.2).¹ Tangible demand for ESSs is being created today by programs like California’s Assembly Bill 2514 (AB2514), which requires utilities to procure 1.325 gigawatts (GW)ⁱ of energy storage capability by 2020, and to install this capability by 2024.² While a range of energy storage options exists, no single technology is suitable for all applications. Section C.3 of this appendix reviews current ESS options, which vary in their performance characteristics, level of technological maturity, and cost. Section C.4 discusses the suitability of these options in different applications. For instance, flywheels are better suited for applications that require high power and fast response times, such as uninterruptible power supply, but not for bulk energy storage, where technologies such as pumped hydro or compressed air are more cost-competitive. In cases where there are no transmission or distribution constraints and other proximity benefits do not exist, grid-connected energy storage does not need to be co-located with the energy source. This provides the flexibility

to optimize storage performance characteristics and minimize costs. Increased deployment of energy storage assets can enable the provision of indirect services such as the ability to defer transmission and distribution (T&D) upgrades, increase system capacity, and exploit arbitrage opportunities, as discussed in Section C.5. The technical and economic barriers to wide-scale ESS deployment are identified in Section C.6.

This appendix reviews the leading grid-scale energy storage systems, with a focus on technologies that are either deployed or in the demonstration phase. We touch only briefly on vehicle-to-grid enabled storage, but provide references to relevant publications on this topic. Solar-to-fuels technologies are not discussed in this report, as they are the subject of a separate MIT Energy Initiative working paper.³

C.2 ENERGY STORAGE SERVICES

Energy storage services can broadly be classified in five categories: bulk energy, ancillary, transmission and distribution, renewables integration, and customer energy management.

This section provides a list of services that can be provided by storage, their definitions (adapted from the International Energy Agency’s *Technology Roadmap: Energy Storage*⁴), and respective performance characteristics (Table C.1). In practical usage, a single ESS technology or several ESS technologies may support multiple services.

ⁱNote that, in general, electricity generation metrics are reported as the system power rating or the electricity generation capacity in watts (W) and a discharge duration in hours (h) at that rated power. Together these terms give an operational energy storage capacity (watt hours [Wh]). Practically, for energy storage technologies, the total storage capacity (Wh) is a critical metric as different discharge rates may be employed depending on the user profile. Where possible, we report all three metrics in our discussion of different ESS technologies.

**Table C.1 Key Characteristics of Storage Systems for Selected Energy Services
(Adapted from International Energy Agency⁴)**

Services	Size (MW)	Discharge duration	Cycles (typical)	Response time	Output (electricity 'e', thermal 't')
Bulk energy services					
Seasonal storage	500–2,000	d – mo	1–5 /y	d	e, t
Arbitrage	100–2,000	8–24 h	0.25–1 /d	> 1 h	e
Ancillary services					
Frequency regulation	1–2,000	1–15 min	20–40 /d	1 min	e
Load following	1–2,000	15 min – 1 d	1–29 /d	< 15 min	e, t
Voltage support	1–40	1–60 s	10–100 /d	0.001–1 s	e
Black start	0.1–400	1–4 h	< 1 /y	< 1 h	e
Spinning reserve	10–2,000	15 min – 2 h	0.5–2 /d	< 15 min	e
Non-spinning reserve	10–2,000	15 min – 2 h	0.5–2 /d	> 15 min	e
Transmission and distribution infrastructure services					
Transmission and Distribution T&D investment deferral	1–500	2–5 h	0.75–1.25 /d	> 1 h	e, t
T&D congestion relief	10–500	2–4 h	0.14–1.25 /d	> 1 h	e, t
Renewable and other integration services					
Variable supply resource integration	1–400	1 min – h	0.5–2 /d	< 15 min	e, t
Waste heat utilization	1–10	1–24 h	1–20 /d	< 10 min	t
Combined heat and power	1–5	min – h	1–10 /d	< 15 min	t
Customer energy management services					
Demand shifting and peak reduction	0.001–1	min – h	1–29 /d	< 15 min	e, t
Off-grid	0.001–0.01	3–5 h	0.75–1.5 /d	< 1 h	e, t

Bulk energy services provide large-scale and, often, long-duration storage. At the bulk scale, ESSs can be used to increase overall grid capacity (seasonal storage), or for price arbitrage, as defined below. Installed capacities are similar to those of natural gas-fired peaking plants.

Seasonal storage refers to longer-term storage of energy, ranging from days to months (for example, thermal energy storage during summer months for use in winter).

Arbitrage refers to energy storage during off-peak hours, when electricity prices are low, so that the stored electricity can be sold during peak demand hours for a profit. This may occur within the same energy market or between two separate markets.

ESS assets that provide **ancillary services** deliver power for short durations, relative to bulk services, but require faster response times (from less than a second to minutes). The following are some of the key ancillary services that energy storage technologies can provide to the grid.

Frequency regulation is the use of storage to dampen the fluctuations caused by momentary differences between power generation and load demand. This is often performed automatically on a minute-to-minute, or shorter, basis.

Load following, similar to frequency regulation, is a continuous electricity balancing mechanism that manages system fluctuations. However, in this case, the time frame of the intervention is longer, ranging from 15 minutes to 24 hours, and is performed either automatically or manually.

Voltage support refers to the maintenance of voltage levels in the transmission and distribution system through the injection and absorption of reactive power.

Black start capability enables a power station to restart without relying on the transmission network in the event of a wide-area power system collapse.

Spinning reserve acts as the reserve capacity (extra generating capacity) that is on line and synchronized to the grid with a response time of less than 10 minutes. This reserve is used to maintain system frequency stability during unforeseen load swings or emergency conditions.⁵

Non-spinning reserve is a form of reserve capacity similar to spinning reserve; however, this reserve capacity is off line and can be ramped up and synchronized to the grid in less than 10 minutes and maintained for at least 2 hours.⁵

Transmission and distribution (T&D) infrastructure services help defer the need for capital-intensive T&D upgrades or investments to relieve temporary congestion in the T&D network.

T&D investment deferral refers to the use of energy storage assets to help defer large investments in the T&D infrastructure by mitigating substation overload for a period of time. Services can also include the permanent removal of overloads due to negative loads that could arise in a PV-connected circuit.⁶

T&D congestion relief refers to energy storage assets that temporarily address congestion in the T&D network.

Renewables and other integration services can be used in conjunction with an intermittent renewable energy source (like wind or solar) to address variability, or with other energy sources to improve efficiency.

Variable supply resource integration refers to storage technologies deployed to integrate intermittent electricity generators, such as renewables, into the grid while compensating for the variability in their energy or power output.

Waste heat utilization refers to energy storage resources used to prevent heat energy from being wasted, when the supply (e.g., from thermal power plants) exceeds end-user demand (e.g., building heating/cooling loads).

Combined heat and power (CHP) refers to electricity and thermal energy storage in CHP plants to help bridge demand gaps.

Customer energy management services may be provided by storage systems that tend to have much smaller capacity than those previously mentioned. These systems are generally located at the end of the electricity distribution network.

Demand shifting and peak reduction refers to energy storage technologies or strategies that facilitate shifts in demand at times of peak energy demand to reduce the load level.

Off-grid refers to technologies that help customers not connected to the electricity grid meet electrical demand needs with variable supply (from locally available fossil or renewable energy resources), thereby ensuring a more reliable power supply.

C.3 ENERGY STORAGE SYSTEMS

Electrical energy is stored in numerous ways that differ in cost, performance, and technological maturity. Figure C.1 shows a number of storage technologies that have either been deployed or are in the demonstration phase, organized by their storage function and as a percentage of U.S. and global electricity generation capacity (expressed in gigawatts [GW]). The United States has approximately 240 gigawatt hours (GWh) of energy storage capacity, which represents about 2.3% of overall U.S. electricity generation capacity. Of this total, **most storage capacity in the United States — 96% — is provided by pumped hydroelectric (pumped hydro) systems.**¹ Compressed air energy storage (CAES), flywheels, rechargeable batteries, and molten salt-based thermal storage are the other mature storage technologies. Electrochemical capacitors and superconducting magnet energy storage (SMES) are promising technologies in the demonstration or advanced research phase. A brief description of each of the above technologies follows.

Pumped Hydroelectric Energy Storage

Pumped hydro systems operate by transporting water between two reservoirs at different elevations, thereby converting between electrical, kinetic, and potential energy to store and deliver electricity. To store energy, water is pumped to the higher elevation reservoir, while to recover the stored energy — either at times of higher demand or for economic reasons such as price arbitrage — the water is allowed to flow down through a turbine to generate electricity. Pumped hydro is a mature energy storage technology, with 270 pumped hydroelectric storage stations currently in operation globally that together provide over 120 GW of electricity generating capacity.¹²

Pumped hydro is best suited for bulk power management applications since it can operate at high power ratings, with module sizes up to the GW range and can provide relatively stable power output for long periods of time, typically tens of hours. In contrast to rechargeable batteries and flywheels, pumped hydro has a relatively slow response time (typically 0.5–15 minutes). The recent introduction of variable speed pumping, however, enables a new level of flexibility that allows pumped hydro to deliver a broader range of services, such as frequency regulation through faster response times.¹³ Variable speed is achieved by decoupling the magnetic field of the stator from that of the rotor, unlike a conventional single-speed pump-turbine in which the stator and rotor remain coupled.¹⁴ Pumped hydro, however, suffers from constraints arising from its dependence on suitable geographical settings as well as from constraints related to licensing requirements, environmental regulations, and uncertainty in long-term electric markets.^{1,15}

Figure C.1 Grid-Related Energy Storage Technologies Deployed or in the Demonstration Phaseⁱⁱ

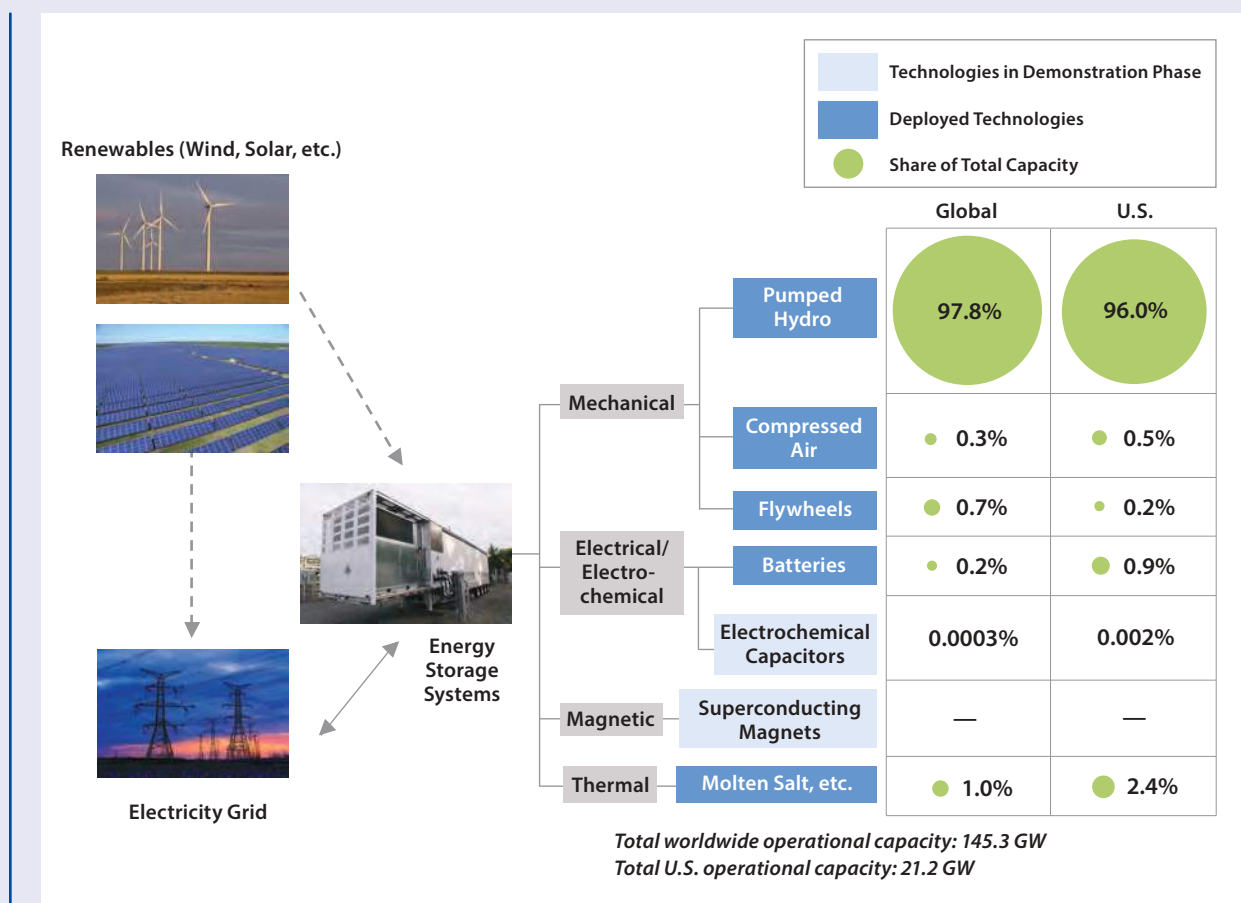

Note: Already deployed technologies are indicated by a dark blue box, while those in the demonstration phase are shown in light blue. The percentage of total storage capacity each ESS technology represents is both listed and indicated with a green bubble of corresponding size. The reported percentages were derived from data obtained from the U.S. Department of Energy (DOE) Global Energy Storage Database.⁷ Images are from the Creative Commons website.^{8,9,10,11}

Compressed Air Storage

Compressed air energy storage (CAES) works by capturing and storing air, typically in vast underground geological formations, when electricity production capacity exceeds demand or when generation is economical. The compressed air is then released via a gas turbine to generate electricity at times of peak demand or to capture the benefits of arbitrage. There are

currently two commercially operating CAES systems in the world: a 290-megawatt (MW) plant in Huntorf, Germany, built in 1978, and a 110-MW plant in McIntosh, Alabama that was commissioned in 1991. In both cases, compressed air is stored in excavated salt caverns.¹² Several companies are now developing smaller CAES systems that store compressed air in above-ground tanks and employ more efficient compression and conversion

ⁱⁱThermal storage technologies include chilled water thermal storage, ice thermal storage, and heat thermal storage. More information on these types of systems can be found in the DOE Energy Storage Database.⁷

technologies to reduce system losses (e.g., isothermal compression).^{16,17,18} Others are exploring a broader range of geological formations as storage media for compressed air; porous rock, for example, may provide large-capacity storage opportunities and is also more geographically abundant.¹⁹ Efforts are also being made to develop underwater CAES in which the air is first compressed onshore and then stored in subaqueous formations in high-strength polymer/glass bags.^{20,21} Like pumped hydro, traditional CAES targets bulk power management applications, but also requires specific geographic conditions, which limits location and scalability. When compared to other ESS technologies (Table C.2), CAES plants often have lower than desirable roundtrip efficiencies (e.g., 27% for the McIntosh plant²²).

Flywheel Storage

Flywheel energy systems store rotational kinetic energy via a spinning rotor-disk in a vacuum chamber. The rotor speed is increased or decreased to store or deliver electricity. Flywheels can respond in less than a second, but are significantly more expensive than other storage technologies described in this appendix. Thus, they are typically deployed for niche applications that require very fast response times and shorter discharge durations. Flywheels are currently commercially deployed primarily for frequency regulation (e.g., Beacon Power's 20-MW flywheel installations for the independent system operators of New York and California, NYISO and CAISO¹⁷). Given their suitability for shorter discharge-time applications, flywheels currently comprise only about 0.2% of total electricity storage capacity in the United States.¹ Flywheel energy storage systems suffer from high self-discharge rates; these high discharge rates arise from frictional losses that can amount to as much as 100% of the energy stored per day.²³

Batteries

Rechargeable electrochemical cells transform electrical energy into chemical energy (and vice versa) through redox (reduction and oxidation) processes that occur at negative (lower potential) and positive (higher potential) electrodes with a working ion, such as lithium, transferring between the two. Batteries typically consist of several individual cells, arranged in series or in parallel, and can be sized and sited without geographical constraints. **Of the technologies mentioned in this appendix, batteries are perhaps the most versatile.** Their applications range from frequency regulation to T&D grid support, though system chemistries and design generally target specific applications.^{1,24} Due to a range of technical and economic challenges, however, battery storage presently comprises only about 0.2% of global grid storage capacity and 0.9% of U.S. capacity.¹ Of the numerous battery chemistries and configurations that have been developed, lithium-ion (Li-ion), sodium sulfur (NaS), and lead-acid batteries are considered mature while technologies such as advanced lead-carbon and flow batteries are still in the demonstration phase.²⁵

Lithium-Ion Batteries

Li-ion batteries operate by shuttling lithium ions (Li⁺) between the positive and negative electrodes in a “rocking chair” mechanism as the cell is charged and discharged. The positive electrode material is typically a transition metal oxide or phosphate with a layered or tunneled structure on an aluminum foil current collector, while the negative electrode typically consists of graphite or another layered material on a copper foil current collector. The charge and discharge processes involve the insertion and extraction of lithium ions into and out of the atomic layers within the active materials. Near ubiquitous in portable electronics and emerging electric vehicles (EVs), Li-ion batteries

have high energy (and power) densities, high roundtrip efficiencies, and rapid response times, which make them well suited for power management applications for uninterruptible power supply or frequency regulation. At present, Li-ion batteries are limited by high system costs, constraints on cycle life, and safety concerns (e.g., flammable electrolytes). **The application of new high-capacity electrode materials, optimization of electrode coating thicknesses, and improvements in manufacturing are expected to play a major role in bringing down costs in the future.**^{26,27,28}

High-Temperature Batteries

Molten sodium sulfur (NaS) batteries operate at high temperatures (310°C–350°C)²⁹ to take advantage of the increased conductivity of the sodium-conducting alumina ceramic that separates two liquid electrodes: sodium (Na) as the negative electrode and sulfur (S) as the positive electrode. During charge and discharge processes, sodium ions (Na⁺) shuttle across the membrane and reversibly alloy with sulfur (Na₂S₅). NaS batteries have high energy densities but limited power capabilities as compared to Li-ion batteries. For this reason, they are generally employed for longer duration applications (4–8 hours). While high efficiency and abundant, low-cost active materials make this technology attractive, thermal management, cell and component reliability, and system safety are challenges.³⁰ Continued research and development (R&D) efforts aim to reduce operating temperature and to employ alternative, less expensive Na⁺ conductors. Like NaS batteries, sodium-nickel-chloride batteries (also referred to as ZEBRA batteries) are high-temperature devices that operate around 270°C–350°C.²⁹ Charging involves the transformation of salt (NaCl₂) and nickel (Ni) into nickel chloride (NiCl₂) and molten sodium (Na) while discharging reverses the process.

Lead-Acid Batteries

Widely employed for starter-lighter-ignition applications in vehicles, lead-acid batteries employ a lead oxide positive electrode and a lead metal negative electrode in a sulfuric acid electrolyte. During charge and discharge, these electrodes are both reversibly converted to lead sulfate. While relatively inexpensive, due in part to large-scale manufacturing and recycling, traditional lead-acid batteries are hampered by low practical energy density as a result of limited electrode utilization (e.g., 20%–30% for grid energy applications³¹). This shortcoming has prompted efforts to develop lead-acid carbon and advanced lead-acid batteries. Lead-acid carbon batteries replace the bulk lead negative electrode with a high-surface-area carbon material, which leads to longer lifetimes and higher energy density due to deeper discharge capabilities. Advanced lead-acid batteries are conventional lead-acid batteries that incorporate technological improvements, such as a solid electrolyte-electrode configuration or a capacitive storage negative electrode.²⁵

Flow Batteries

Unlike the rechargeable batteries described above, which have enclosed architectures, redox flow batteries store energy in flowable solutions of electroactive species. The solutions are housed in external tanks and pumped to a power-generating electroreactor. This architecture offers several advantages including the ability to decouple power (reactor size) from energy (tank size), a high ratio of active to inactive materials, simplified manufacturing, long service life with full charge/discharge cycles, and improved safety. However, due to their low energy density and integrated design requirements, flow batteries are best suited for MW-scale energy storage with longer duration (greater than 4 hours).¹ First developed in the 1970s, numerous flow battery chemistries have been explored including iron-chromium,

bromine-polysulfide, vanadium-polyhalide, and all-vanadium systems. In addition, several hybrid systems have been pursued, in which one or both electrode reactions involve a deposition/dissolution process, such as zinc-bromine and soluble lead-acid systems. Though only sporadically investigated for the past 40 years, the renaissance of renewable electricity generators has spurred R&D to lower costs and improve energy density, including efforts to develop high-performance electroreactors, new electrolyte formulations, and new tailored redox molecules.³²

In addition to these technologies, other battery chemistries, including lithium-sulfur, aqueous sodium ion, liquid metal, semi-solid flow, and zinc-air, are at various stages of development and may eventually provide lower-cost alternatives to existing technologies.¹

Electrochemical Capacitors

Electrochemical capacitors (also referred to as supercapacitors) store charge in the electrical double layers present between two porous, high-surface-area electrodes and a common electrolyte rather than through the faradaic redox reactions common to batteries.¹ In general, this leads to higher roundtrip efficiencies, fewer parasitic side reactions, and faster response times, but these benefits come at the expense of energy density. Thus, electrochemical capacitors demonstrate higher power densities, longer useful lifetimes, and lower energy densities when compared to rechargeable batteries. Present electrochemical capacitor technologies generally target high-power, short-duration applications, such as frequency regulation. If longer discharge times are required, these technologies generally become cost prohibitive. Ongoing research efforts to develop pseudo-capacitors that combine faradaic and non-faradaic storage mechanisms as well as flow-based cell architectures may eventually serve to enhance energy density.^{33,34}

Superconducting Magnet Energy Storage

Though still in the demonstration phase, superconducting magnetic energy storage (SMES) offers high roundtrip efficiency in addition to providing long cycle life and high power density.¹ SMES systems consist of a superconducting coil, a power conditioning system, and a refrigeration unit. Electrical energy is stored inductively in a solenoid in the form of magnetic energy. Cryogenic temperatures (less than 4.2 Kelvin when liquid helium is used) must be maintained to facilitate the flow of electric current with minimal resistance. Low energy density and high manufacturing cost make this technology more suited to supplying short bursts of electricity in applications such as uninterruptible power supply.

Molten Salt Energy Storage

Molten salt energy storage, briefly described in conjunction with concentrated solar power (CSP) generation in Chapter 3 of this report, employs high-temperature liquefied salts (450°C–600°C) to store thermal energy. After heating in parabolic solar troughs, the molten salt is stored in an insulated chamber until electricity is required, at which time the molten salt is used to generate steam to drive a turbine. Molten salt energy storage currently accounts for 2.4% of operational energy storage capacity in the United States, and promises energy storage at much lower cost compared to other technologies.¹ Present research initiatives are focused on further cost reductions through technology improvement, such as the development of capsules for salts that facilitate operation with one storage tank instead of two.³⁵

Another emerging technology worth mentioning here is pumped heat energy storage (PHES). PHES systems store electricity by first converting it to thermal energy using a heat pump cycle; this thermal energy is later converted back to electricity using a power cycle. The efficiency

of such systems depends on the difference between the operating temperatures of the heat pump and power cycles and can be as high as 65%–70%.³⁶ In some cases, efficiencies as high as 72%–80% have been reported with costs comparable to those of pumped hydro storage.³⁷

C.4 ENERGY STORAGE SYSTEMS AND THEIR APPLICATIONS

The particular attributes of each ESS technology, described in the preceding section, make each one suited to provide certain services that address particular application needs. **Relevant considerations include discharge duration,**

power capability, response time, lifetime, and roundtrip efficiency. Table 2 summarizes the key attributes of various energy storage technologies, as well as their technological maturity. Attributes such as discharge duration, power capability, and response time, as well as system cost, tend to drive market share and installed capacity of these technologies. **Other than pumped hydro,** which is attractive due to its relative low cost and bulk-storage attributes, and which currently represents over 97% of world-wide energy storage capacity (Figure C.1), **most of the ESS technologies included in Table C.2 are currently too costly for widespread deployment.** Figure C.2 maps the ESS

Table C.2 Comparison of ESS Attributes and Associated Deployment Constraints and Challenges

	Pumped Hydro	CAES	Flywheels	Batteries					Superconducting Magnets	Electrochemical Capacitors	Molten Salt
				NaS	Li-ion	Lead-acid	Flow	Sodium-nickel-chloride (ZEBRA)			
Total Plant Cost (\$/kWh)	150–370	90–420	~9,400	380–450	920–4,690	300–3,070	220–3,750	480–1,500	–	–	–
Primary Applications	Bulk, Anc.	Bulk, Ren. Int., Anc.	Anc.	T&D, Ren. Int., Anc.	T&D, Ren. Int., Anc.	T&D, Ren. Int., CEMS	T&D, Ren. Int., Anc.	T&D, Ren. Int., Anc.	Anc.	Anc.	Ren. Int.
Response time	s-min	s-min	< s	< s	< s	< s	s	< s	< s	< s	min
Lifetime (y)	50–60	25–40	~20	15–20	5–15	~15	5–20	10–14	20+	4–12	~30
Cycles	20k–50k	5k–20k	> 100k	2.5k–4.5k	1k–10k+	2.2k–4.5k	> 10k	> 2,000	100k+	100k+	–
Maturity	Deployed	Deployed	Deployed	Deployed	Deployed	Deployed	Demo	Deployed	Demo	Demo	Deployed
Roundtrip Efficiency (%)	75–85	27–54	70–80	85–90	75–90	75–90	60–75	85–90	70–80	85–98	80–90
Capacity (MWh)	1,680–14,000	1,080–3,600	0.0005–0.025	≤ 204	0.25–25	0.25–500	0.01–250	0.01–10s	–	–	–
Discharge duration	6–10 h	8–26 h	s	~6 h	0.25–1 h	0.25–10 h	2–5 h	h	s	ms-min	h
Power (MW)	280–4k	3–400	0.002–20	0.5–50	1–100	0.01–100	0.03–50	0.005–10s	0.1–10	0.001–1	~150
Key challenges	Geog. limits	Geog. limits	Cost	High operating temp.	Cost	Environ. impacts	Energy density	High operating temp.	Cost	Cost	Suitable only with CSP

Note: The data presented in the table are taken from various sources.^{1,16,22,23,38,39,40,41,42,43} Cost values have been adjusted to 2015 dollars using U.S. Gross Domestic Product (GDP) deflators.⁴⁴ Boxes for some of the attributes have been shaded to help the reader distinguish between values. Darker shades of green indicate increasingly desirable properties, red shading indicates undesirable properties, and gray shading indicates that no information is available. Capacities, discharge durations, and power represent typical ranges of installations. CAES capacities include underground as well as aboveground air storage. Flywheel capacities include planned flywheels. The upper limit given for NaS battery capacity (204 MWh) is based on the Rokkasho wind project in Japan. Primary applications for the different storage technologies are labeled Ren. Int. for renewable integration, Anc. for ancillary services, T&D for transmission and distribution services, and CEMS for customer energy management services.

Figure C.2 ESS Technologies and Associated Applications

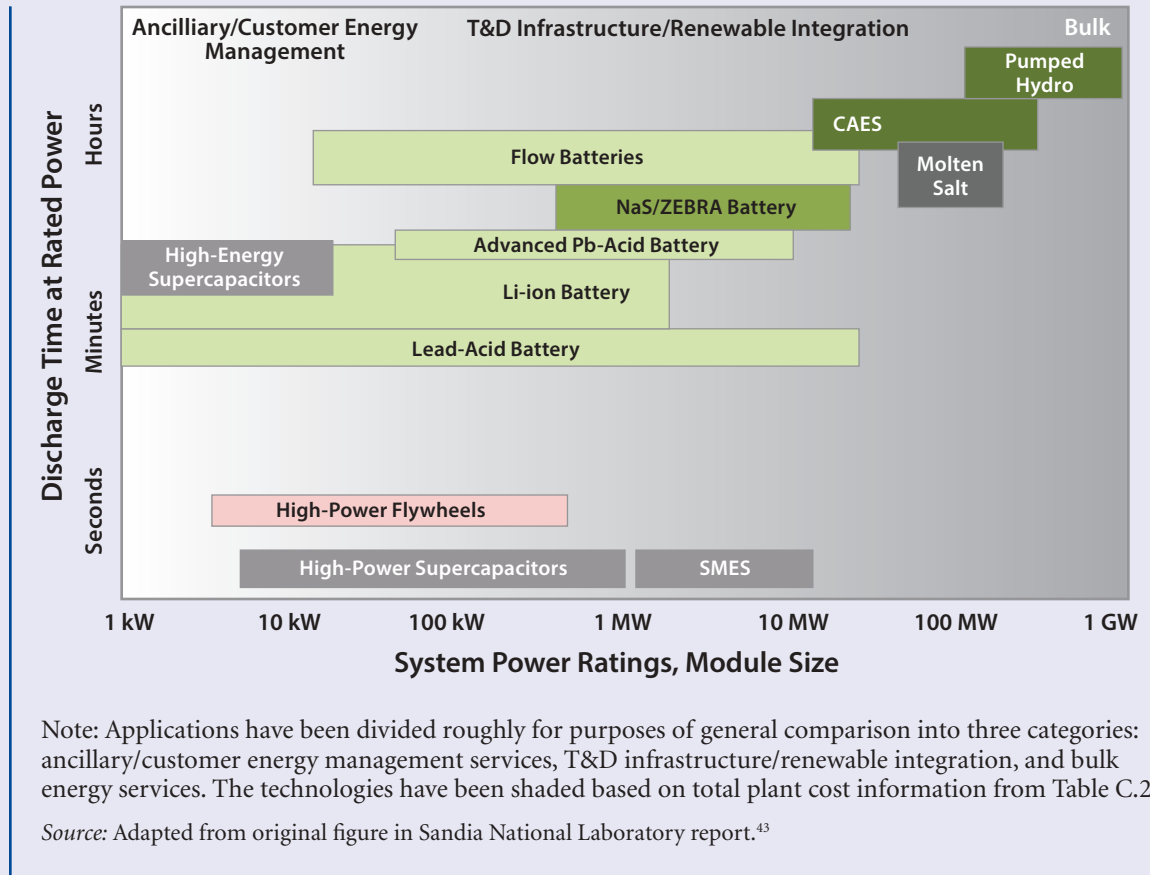

technologies to the types of services they can provide based on the performance attributes summarized in Table C.2. These applications can be divided into three broad segments according to their associated discharge time and system power requirements: ancillary/customer energy management, T&D infrastructure/renewable integration, and bulk energy services.

Solar-Related Energy Storage Systems

The DOE Global Energy Storage Database lists 160 operational energy storage projects related to solar energy productionⁱⁱⁱ worldwide. Together, these storage projects have a total rated power of approximately 1.5 GW. Seventy-six of these projects, totaling about 389 MW, are sited in the United States, including the installations described in Chapter 3. Spain leads

ⁱⁱⁱThe figure does not include 20 pumped hydro energy storage projects, mostly in Spain and China, that were constructed to help support the integration of variable renewable resources, such as wind and solar.

the list with approximately 1 GW of operational projects. Figure C.3a shows the breakdown of storage technologies deployed worldwide. Of these, **thermal storage comprises about 96% (1.4 GW) of operational projects**. Thermal storage plants are best suited for CSP systems, as discussed in Chapter 3, and are co-located with solar panels. Thermal plants are intended to provide bulk energy services, hence thermal plants are several orders of magnitude larger than rechargeable battery installations.

Apart from the *operational* projects listed in the DOE database, an additional 89 projects are either under construction, announced, or contracted. **The share of storage projects that uses battery technology appears to be increasing** from 4% (61 MW) of currently operational projects (Figure C.3a) to 7% (122 MW) for planned projects (Figure C.3b). Electrochemical capacitors appear to be a major new contributor, due to projects under construction in Israel, Malaysia, and India; together these projects account for 2% (45 MW) of planned new capacity.

Figure C.3 Global Solar-Related Energy Storage Capacity by Technology

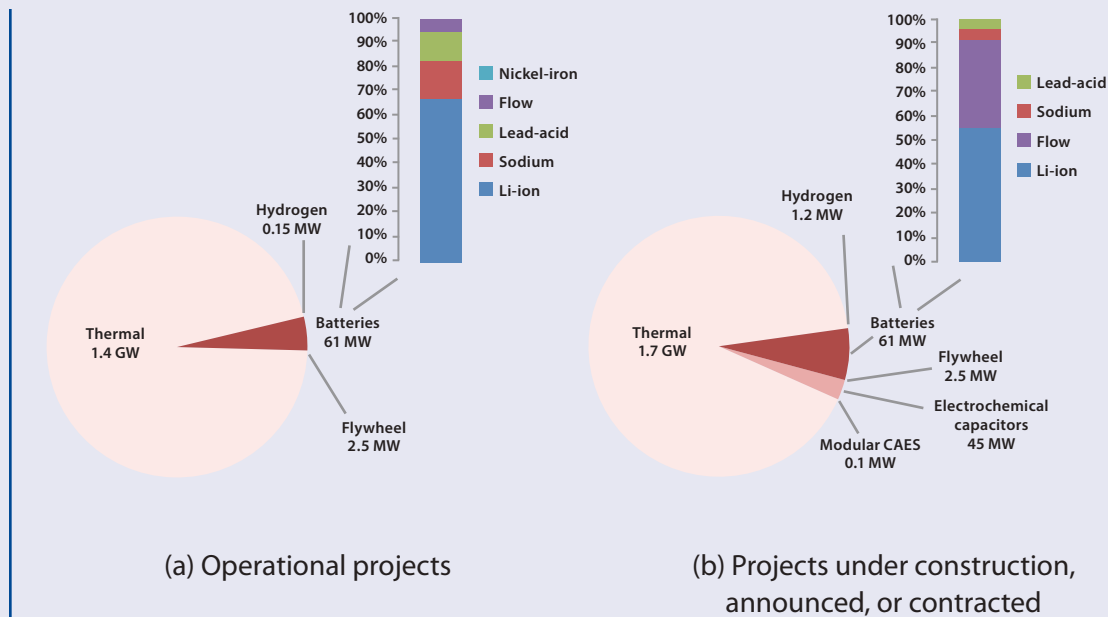

Note: This figure excludes pumped hydro storage.

Data source: DOE Energy Storage Database as of 2 December 2014⁷

C.5 SOLAR INTEGRATION — A DRIVER FOR ENERGY STORAGE SERVICES AND SYSTEMS

Solar electricity production may influence the deployment of stationary ESSs and their future applicability for both grid-connected and off-grid services. Chapter 8 shows how energy storage can help increase the market remuneration of solar PV owners, by increasing electricity prices in net load valleys (since storage allows PV owners to take advantage of low prices during valley hours to store energy).

A 2013 study⁴⁵ by the Electric Power Research Institute (EPRI) considered three different use cases for energy storage systems (bulk storage, ancillary services, and distributed storage sited at the utility substation) and analyzed their cost-effectiveness.^{iv} While the analysis runs conducted for the different use cases varied in terms of key inputs and associated sensitivities provided by the California Public Utilities Commission (CPUC), EPRI reported a benefit-to-cost ratio greater than one for most runs.⁴⁵ Under the assumptions of the study, **frequency regulation service was reported as the most cost-effective application for energy storage, albeit one for which there is limited demand.**⁴⁵ Distributed energy storage at utility substations was also found to be of significant value in terms of the ability to defer upgrades to distribution assets.⁴⁵ A report by DNV KEMA also highlights the benefits that storage systems can provide in terms of deferring upgrades that include re-conductoring, and regulation costs.⁶ Greater benefits from upgrade deferral were realized when the ESS was mobile and could be deployed to multiple sites.⁶ Additional benefits from improved power quality and system reliability are also anticipated.

Currently, thermal energy storage systems comprise the majority of installed energy storage capacity (Section C.4). These thermal energy storage projects are mostly coupled with CSP; by contrast, a recent study by Navigant Consulting suggests that batteries will be the dominant energy storage technology for solar PV and wind integration worldwide by 2023.⁴⁶

The adoption of electric vehicles (EVs) can also facilitate increasing levels of solar penetration through vehicle-to-grid (V2G) power provided by the Li-ion battery packs in EVs. At higher levels of variable renewable power generation, access to V2G power can produce annual net social benefits as high as \$300–\$400 as a result of avoided costs for new generation plants to meet peak demand. Realistic arbitrage profits for vehicle owners have been calculated to range from approximately \$6 to \$72 per year. Arbitrage profits to EV owners, however, are expected to decline, as the number of vehicles providing V2G power increases (for more information, see Peterson, Whitacre, and Apt⁴⁷).

Increased adoption of solar technologies in developing countries may also effect ESS adoption, while ESS adoption, in turn, could affect the services provided by renewable energy systems. This topic, covered in a related working paper titled *Solar Power Applications in the Developing World*,⁴⁸ is especially relevant in parts of the world where large numbers of people lack access to electricity, as is currently the case for 70% of the 600 million people living in sub-Saharan Africa.⁴⁹ The limited availability of electricity and the underdeveloped, or in many cases non-existent, transmission infrastructure in Africa makes distributed generation through microgrids potentially attractive as a rapid way to electrify regions.

^{iv}In this case, cost-effectiveness is defined as the ratio of direct and quantifiable benefits from a storage system that provides specific grid services over its lifetime to the associated costs of that system on a net present value basis.

Africa is unique in that solar power on the continent mostly enables off-grid energy access, rather than providing grid-connected generation as in developed economies.⁵⁰ While questions remain about whether microgrids can be used to economically electrify larger-scale, off-grid communities, microgrids have been successfully deployed at smaller scales in several developing countries and island nations.⁵¹ Given the high costs associated with building a T&D network, the concept of using clusters of microgrids for future system expansion has been proposed.⁵²

C.6 BARRIERS TO DEPLOYMENT AND THE NEAR-TERM TRAJECTORY OF SOLAR ENERGY STORAGE

Figure C.4 shows PV installations in the United States between 2000 and 2013. The utility sector accounts for most of the growth shown in the figure, adding 2,847 MW of solar PV generating capacity over this period. In addition to PV installations, a further 410 MW of CSP capacity was installed in 2013.⁵³

Figure C.4 Total U.S. PV Installations from 2000 to 2012, Disaggregated by Installation Scale

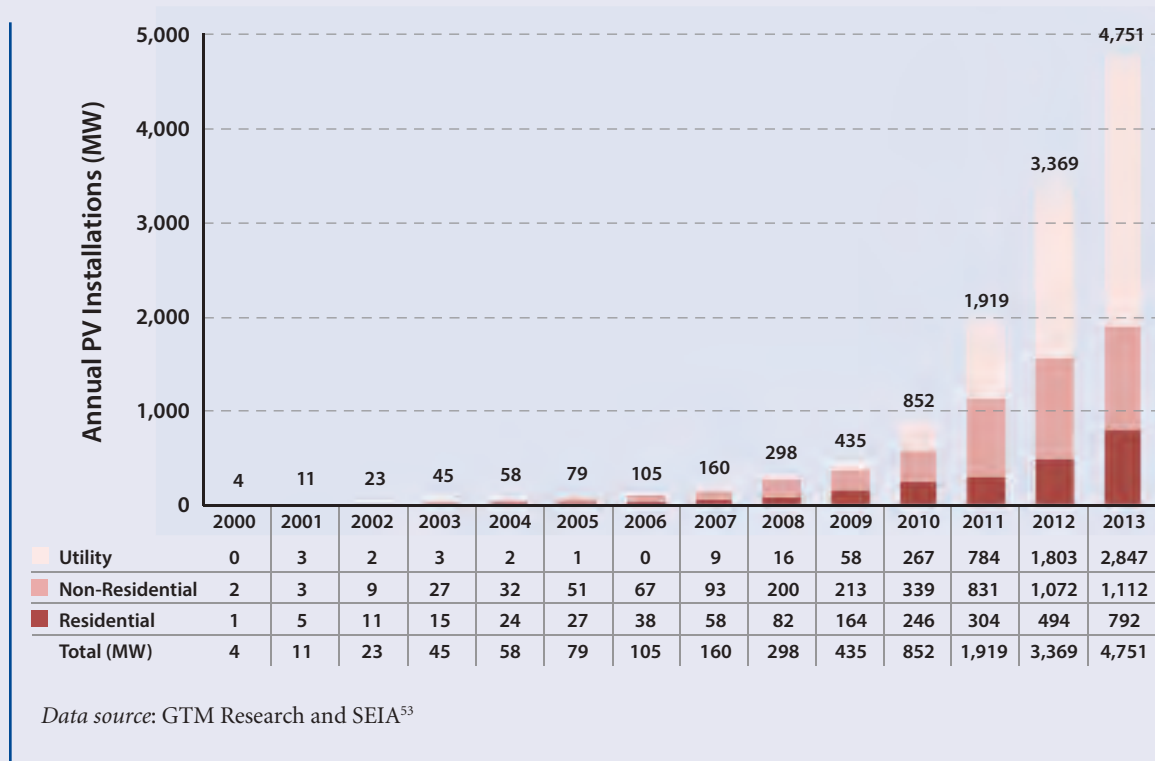

This growth trend is expected to continue worldwide, at least in the near future.

Projections for the future contribution from solar PV vary widely: from as little as 1% of global demand in 2030⁵⁴ to as much as 75%.⁵⁵

In 2013, the world had about 130 GW of installed PV capacity and PV accounted for approximately 0.85% of global electricity production.⁵⁶ Europe alone had 80 GW of installed solar capacity. Within Europe, Germany is the leader, with 35 GW of installed capacity.⁵⁷ **Continued growth in solar energy production will invariably result in higher demand for energy storage.** However, the U.S. DOE has identified four key barriers that must be overcome to enable large-scale deployment of energy storage systems:¹

Cost Competitiveness — To be competitive with currently available, non-storage-based options (e.g., natural gas peaker plants), the total cost of storage systems — including subsystem components, installation, and integration costs — must be reduced. DOE's near-term goal is to reduce the capital cost for grid-level storage systems to \$250/kWh with a long-term cost goal of \$150/kWh.¹ For CSP energy storage systems, DOE has set its long-term system-capital-cost goal at \$15/kWh.¹ While significant research efforts have focused on lowering “storage” component costs, these represent only a fraction of total system costs (30%–40%) with the remainder of system costs coming from the power conversion system and the balance of plant. Thus, **future research needs to focus on the entire energy storage system.** In addition, a better understanding of the value proposition of storage technologies, both for individual and multiple grid services,

is required. Indeed, **the fact that a single storage technology may capture several revenue streams (e.g., renewable storage, upgrade deferral) can change its economic viability.**

Independent validation of performance and safety — A unified basis for evaluating and reporting the performance of existing and emerging storage technologies, combined with industry-accepted codes and standards to specify desired performance parameters for each storage service, will lead to broader acceptance. For example, there is marked uncertainty over the usable life of batteries and the period over which a storage installation can generate revenue — both of which impact investment calculations. Developing rigorous accelerated testing protocols, similar to those established for fuel cells and rechargeable batteries in the transportation sector, is critical. In addition, operational safety for large storage systems is an important concern, especially for systems deployed in urban areas or in proximity to high-energy infrastructure (e.g., substations). The Battery Energy Storage Technology (BEST) Testing and Commercialization Center,^v in Rochester, New York, represents one effort to address these concerns.⁵⁸

Clear and Efficient Regulatory Environment — At the moment, consistent pricing for storage-related services or market plans for providing grid storage do not exist, and economic uncertainty inhibits investment. **A clear revenue generation model for storage operators will help clarify opportunities for profitability, reduce uncertainty, and spur investment.**

^vThe Center is the result of a partnership between NY-BEST and DNV KEMA Energy and Sustainability.

Figure C.5 Active ARPA-E Stationary Energy Storage Projects (as of December 2014)

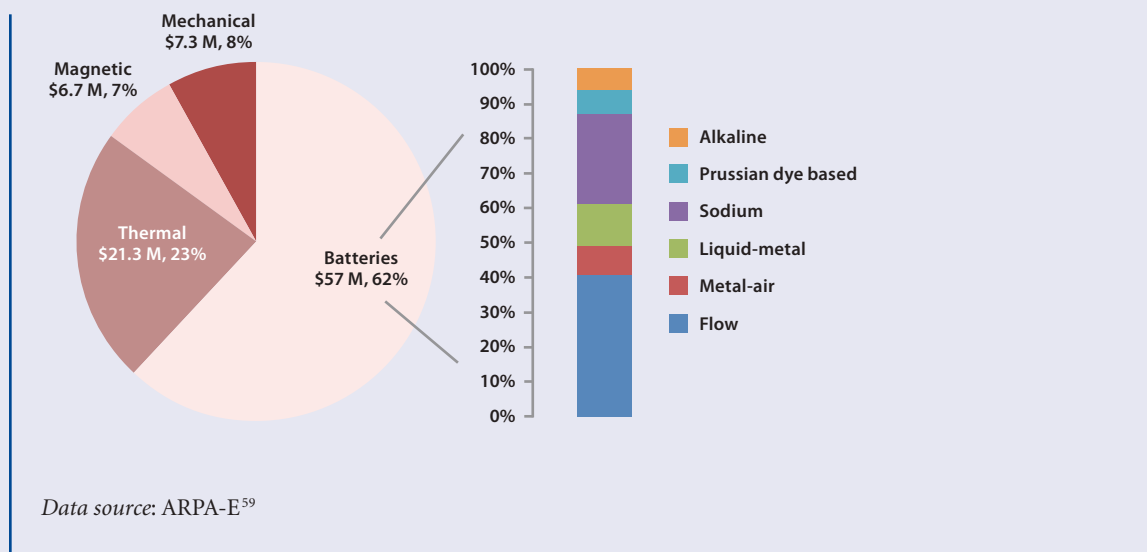

Industry Acceptance — Significant uncertainty exists about how storage systems will be used in practice and how new storage technologies will perform over time in real-world applications. System operators, entrepreneurs, and utility developers lack the design tools to consistently analyze and understand the value-proposition of different storage technologies. **Developing algorithms to optimize storage technology parameters and profitability will likely encourage future investments.**

Overcoming current deployment barriers will require further investments in fundamental science and engineering along with manufacturing innovations, to realize cost-competitive ESSs. Standardized testing protocols and independent prototype testing sites must also be developed to assess performance claims and failure mechanisms; in addition, collaborative public–private sector ventures are needed, both to evaluate the benefits of grid storage and to demonstrate performance through field trials. In the United States, DOE’s Advanced Research Projects Agency–Energy (ARPA–E) aims to accelerate the development of potentially

transformative energy technologies that are too early stage (or high risk) to attract private investment. ARPA-E had a budget of \$280 million in 2014; its budget request for 2015 is \$325 million.⁶⁰ Figure C.5 shows the breakdown of ARPA-E funding, by technology, for currently active stationary energy storage projects. Battery projects represent 62% of the Agency’s total funding for energy storage technologies. ARPA-E’s Grid-Scale Rampable Intermittent Dispatchable Storage (GRIDS) program is developing technologies that can store energy at a cost of less than \$100/kWh.⁶¹ In addition, DOE has funded several integrated research centers, known as Energy Innovation Hubs that are modeled on the strong scientific management characteristics of the Manhattan Project and AT&T Bell Laboratories. These innovation hubs aim to combine basic and applied research with engineering to accelerate scientific discovery that addresses critical energy issues.⁶² The Joint Center for Energy Storage Research (JCESR) brings together a team of researchers from academia, national laboratories, and private industry to advance next-generation electrochemical energy storage

technologies for transportation and the electric power system.⁶³ Specifically, JCESR seeks to integrate fundamental science, battery design, research prototyping, and manufacturing collaboration in a single highly interactive organization to develop potentially transformative “beyond Li-ion” battery chemistries. JCESR has established very aggressive targets, including the development of battery prototypes that — when scaled to manufacturing — can reach price levels that enable widespread market adoption (e.g., \$100 per useable kWh).⁶⁴ ARPA-E and JCESR are just two examples of how public agencies are funding energy storage development efforts in the United States. These efforts will be especially useful in conjunction with policies and programs, such as California’s AB2514 legislation, that by themselves will create strong drivers to address some of the barriers to ESS deployment discussed in this appendix.

C.7 SUMMARY

Demand for ESSs is expected to continue to grow in the near term, as these systems address the variability issues associated with renewable energy sources. Further driving adoption of ESS technologies is their potential to deliver a range of services and capture multiple revenue streams, especially in the context of a clear and efficient regulatory environment, with consistent prices. A variety of ESS technology options are now in different stages of development. While thermal energy storage is currently the dominant storage technology for solar applications, the share of battery systems coupled with solar facilities is expected to grow, as R&D efforts continue to increase their cost competitiveness.

REFERENCES

- ¹Grid Energy Storage – December 2013, U.S. Department of Energy, Office of Electricity Delivery & Energy Reliability. <http://energy.gov/oe/downloads/grid-energy-storage-december-2013>
- ²Proposed Decision – Order Instituting Rulemaking Pursuant to Assembly Bill 2514 to Consider the Adoption of Procurement Targets for Viable and Cost-Effective Energy Storage Systems. California Public Utilities Commission. (2013) <http://docs.cpuc.ca.gov/PublishedDocs/Published/G000/M078/K929/78929853.pdf>
- ³Tuller, H. *Solar to Fuels Conversion*: forthcoming MIT solar study-related publication. (2015). <http://mitei.mit.edu/futureofsolar>
- ⁴Technology Roadmap: Energy Storage. International Energy Agency (March 2014). <http://www.iea.org/publications/freepublications/publication/TechnologyRoadmapEnergyStorage.pdf>
- ⁵Spinning and Non-spinning Reserve. California Independent System Operator. (2006). <http://www.caiso.com/Documents/SpinningReserveandNonSpinningReserve.pdf>
- ⁶Abrams, A., R. Fioravanti, J. Harrison, et al. *Energy Storage Cost-effectiveness Methodology and Preliminary Results, Draft 3*. (June 2013). Prepared for: California Energy Commission. Prepared by: DNV KEMA Energy and Sustainability. http://www.cpuc.ca.gov/NR/rdonlyres/A7FF0A4E-44FA-4281-8F8F-CFB773AC2181/0/DNVKEMA_EnergyStorageCostEffectiveness_Report.pdf
- ⁷DOE Global Energy Storage Database. U.S. Department of Energy. <http://www.energystorageexchange.org>
- ⁸Small Wind Farm Near Caen, Normandy. http://commons.wikimedia.org/wiki/File:C3%89oliennes_Caen.jpg
- ⁹Starokozache Solar Park. <https://www.flickr.com/photos/activsolar/9092131449/in/photolist->
- ¹⁰Storage Trailer: Large Battery Technology at Duke Energy's McAlpine Pilot. <https://www.flickr.com/photos/dukeenergy/4109309191/in/photolist-7g8hvX-6H5tZw-7g8hqa-7g8hst>
- ¹¹Muttoo, I. *Transmission Lines: Line 'Em Up*. <https://www.flickr.com/photos/imuttoo/4257813689/in/photolist->
- ¹²McGrail, B.P., J.E. Cabe, C.L. Davidson, et al., *Techno-economic Performance Evaluation of Compressed Air Energy Storage in the Pacific Northwest*. U.S. DOE Pacific Northwest National Laboratory. PNNL-22235. (February 2013). <http://caes.pnnl.gov/pdf/PNNL-22235.pdf>
- ¹³Challenges and Opportunities for New Pumped Hydro Storage Development. National Hydropower Association. (2012). http://www.hydro.org/wp-content/uploads/2014/01/NHA_PumpedStorage_071212b12.pdf
- ¹⁴Variable Speed Pumped Hydroelectric Storage. Energy Storage Association. (2014). <http://energystorage.org/energy-storage/technologies/variable-speed-pumped-hydroelectric-storage>
- ¹⁵Pumped Storage Provides Grid Reliability Even with Net Generation Loss. U.S. Energy Information Administration. (July 8, 2013). <http://www.eia.gov/todayinenergy/detail.cfm?id=11991>
- ¹⁶New Compressed Air Storage Deals Fatal Blow to Zombie Lies about Wind and Solar. CleanTechnica. (Sep 23, 2013). <http://cleantechnica.com/2013/09/23/sustainx-completes-new-compressed-air-energy-storage-system>
- ¹⁷Advanced Compressed Air Energy Storage Demonstration. Electric Power Research Institute. (Feb 23, 2009). <http://www.epri.com/abstracts/Pages/ProductAbstract.aspx?ProductId=00000000001018785>
- ¹⁸Kanellos, M. *LightSail Shifts from Compressed Air Car to Grid Storage*. Greentech Media. (Apr 14, 2011). <http://www.greentechmedia.com/articles/read/lightsail-shifts-from-compressed-air-car-to-grid-storage>
- ¹⁹Medeiros, M. *Advanced Underground Compressed Air Energy Storage*. Pacific Gas & Electric Company. (Aug 2013). https://www.smartgrid.gov/project/pacific_gas_and_electric_company_advanced_underground_compressed_air_energy_storage
- ²⁰Kanellos, M. *Bright Energy's Twist on CAES: Use the Ocean*. Greentech Media. (Jun 21, 2011). <http://www.greentechmedia.com/articles/read/bright-energys-twist-on-caes-use-the-ocean>
- ²¹Enbysk, L. *Toronto Startup Goes Underwater for Energy Storage*. GIGAOM. (Apr 6, 2012). <https://gigaom.com/2012/04/06/toronto-startup-goes-underwater-for-energy-storage>

- ²²History of First U.S. Compressed-Air Energy Storage (CAES) Plant (110MW 26h): Volume 2: Construction. Electric Power Research Institute. (May 7, 1994). <http://www.epri.com/abstracts/Pages/ProductAbstract.aspx?ProductId=TR-101751-V2>
- ²³Chen, H., T. N. Cong, W. Yang, et al. "Progress in Electrical Energy Storage System: A Critical Review," *Progress in Natural Science* 19, 3 (Mar 10, 2009): 291-312. <http://www.sciencedirect.com/science/article/pii/S100200710800381X>
- ²⁴Carnegie, R., D. Gotham, D. Nderitu, and P.V. Preckel. *Utility Scale Energy Storage Systems: Benefits, Applications, and Technologies*. State Utility Forecasting Group. (June 2013). <http://www.purdue.edu/discoverypark/energy/assets/pdfs/SUFG/publications/SUFG%20Energy%20Storage%20Report.pdf>
- ²⁵*Advanced Materials and Devices for Stationary Electrical Energy Storage Applications*. Nexight Group. (December 2010). http://energy.tms.org/docs/pdfs/Advanced_Materials_for_SEES_2010.pdf
- ²⁶Sakti, A., J. J. Michalek, E.R.H. Fuchs, and J. F. Whitacre. "A Techno-economic Analysis and Optimization of Li-ion Batteries for Light-duty Passenger Vehicle Electrification," *Journal of Power Sources* 273 (2015): 966-980. <http://www.sciencedirect.com/science/article/pii/S0378775314014888>
- ²⁷Sakti, A., I.M.L. Azevedo, E.R.H. Fuchs, et al. *A new framework for technology forecasting: The case of Li-ion Batteries for Plug-in Electric Vehicles*. Work in Progress. (2015).
- ²⁸Gallagher, K.G., S. Goebel, T. Greszler, et al. "Quantifying the Promise of Lithium-air Batteries for Electric Vehicles." *Energy and Environmental Science* 7, (2014): 1555-1563. <http://pubs.rsc.org/en/Content/ArticleLanding/2014/EE/c3ee43870h#!divAbstract>
- ²⁹Linden, D.L. and T.B. Reddy. *Handbook of Batteries, 3rd ed.* McGraw Hill. (2002).
- ³⁰NAS Battery Fire Incident and Response. NGK Insulators, Ltd. <http://www.ngk.co.jp/english/announce/>
- ³¹Srinivasan, V., G. Q. Wang, and C. Y. Wang. "Mathematical Modeling of Current-interrupt and Pulse Operation of Valve-regulated Lead Acid Cells," *Journal of the Electrochemical Society* 150, 3 (2003): A316-A325. <http://jes.ecsdl.org/content/150/3/A316.short>
- ³²Darling, R. M., K. G. Gallagher, J. A. Kowalski, et al. "Pathways to Low-cost Electrochemical Energy Storage: A Comparison of Aqueous and Nonaqueous Flow Batteries," *Energy & Environmental Science* 7, 11 (2014): 3459-3477. <http://pubs.rsc.org/en/content/articlehtml/2014/ee/c4ee02158d>
- ³³Evans, D., "Hybrid Capacitors with High Specific Power." 22nd International Seminar on Double Layer Capacitors and Hybrid Energy Storage Devices, Deerfield Beach, Florida. (Dec. 3-5, 2011). <http://www.evanscap.com/pdf/Capacitors%20with%20High%20Specific%20Power.pdf>
- ³⁴Presser, V., C. R. Dennison, J. Campos, et al. "The Electrochemical Flow Capacitor: A New Concept for Rapid Energy Storage and Recovery," *Advanced Energy Materials* 2, no. 7 (2012): 895-902. <http://onlinelibrary.wiley.com/doi/10.1002/aenm.201100768/full>
- ³⁵Levitan, D. "Terrafore Looks to Cut Molten Salt Energy Storage Costs in Half," *IEEE Spectrum*. (Feb 27, 2014). <http://spectrum.ieee.org/energywise/green-tech/solar/terrafore-looks-to-cut-molten-salt-energy-storage-costs-in-half>
- ³⁶Thess, A. "Thermodynamic Efficiency of Pumped Heat Electricity Storage," *Physical Review Letters* 111, 11 (Sep 13, 2013): 110602. <http://journals.aps.org/prl/abstract/10.1103/PhysRevLett.111.110602>
- ³⁷Isentropic: Electrifying Innovation. Isentropic Limited. (2014). <http://www.isentropic.co.uk>
- ³⁸Rastler, D. M. *Electricity Energy Storage Technology Options: A White Paper Primer on Applications, Costs and Benefits*. Electric Power Research Institute. (Dec. 21, 2010). <http://www.epri.com/abstracts/Pages/ProductAbstract.aspx?productId=00000000001022261>
- ³⁹International Electrotechnical Commission. *Electrical Energy Storage – White Paper*. (Dec 2011). <http://www.iec.ch/whitepaper/energystorage/?ref=extfooter>
- ⁴⁰Ruester, S., X. He, J. Vasconcelos, and J.-M. Glachant. "Electricity Storage: How to Facilitate Its Deployment and Operation in the EU." *Think Final Report*, (Jun. 2012). <http://www.eui.eu/Projects/THINK/Documents/Thinktopic/PB/Policy201205.pdf>
- ⁴¹NAS Battery Energy Storage System. NGK Insulators, Ltd. (Oct 2013). http://www.eei.org/meetings/Meeting_Documents/Abe.pdf

- ⁴²*Electricity Storage*. SBC Energy Institute. (Sep 2013). http://www.sbc.slb.com/SBCInstitute/Publications/~media/Files/SBC%20Energy%20Institute/SBC%20Energy%20Institute_Electricity_Storage%20Factbook_vf1.pdf
- ⁴³Akhil, A.A., G. Huff, A.B. Currier, et al. *DOE/EPRI 2013 Electricity Storage Handbook in Collaboration with NRECA*. Sandia National Laboratories. SAND2013-5131. (Jul 2013). <http://www.sandia.gov/ess/publications/SAND2013-5131.pdf>
- ⁴⁴*Table 10.1 – Gross Domestic Product and Deflators Used in the Historical Tables: 1940-2019*. White House Office of Management and Budget. <http://www.whitehouse.gov/omb/budget/historicals>
- ⁴⁵Kaun, B. *Cost-Effectiveness of Energy Storage in California: Application of ENRI Energy Storage Valuation Tool to Inform the California Public Utility Commission Proceeding R. 10-12-007*. Electric Power Research Institute. (Jun 13, 2013). <http://www.epri.com/abstracts/Pages/ProductAbstract.aspx?ProductId=000000003002001162>
- ⁴⁶Dehamma, A. *In Energy Storage, Power-to-Gas Seeks a Market*. Navigant Research. (Aug 22, 2013). <http://www.navigantresearch.com/blog/in-energy-storage-power-to-gas-seeks-a-market>
- ⁴⁷Peterson, S.B., J. F. Whitacre, and J. Apt. “The Economics of Using Plug-in Hybrid Electric Vehicle Battery Packs for Grid Storage.” *Journal of Power Sources* 195, no. 8 (2010): 2377-2384. <http://www.sciencedirect.com/science/article/pii/S0378775309017303>
- ⁴⁸Rose, A., A. Campanella, R. Amatyia, and R. Stoner. *Solar Power Applications in the Developing World*. forthcoming MIT solar study related publication. (2015). <http://mitei.mit.edu/futureofsolar>
- ⁴⁹*Power Africa*. USAID. <http://www.usaid.gov/powerafrica>
- ⁵⁰Hankins, M. *Why Africa is Missing the Solar Power Boat*. Renewable Energy World. (Apr 3, 2013). <http://www.renewableenergyworld.com/rea/news/article/2013/04/why-africa-is-missing-the-solar-electricity-boat?page=2>
- ⁵¹Bullis, K. “A Billion People in the Dark: Solar Powered Microgrids Could Help Bring Power to Millions of the World’s Poorest,” *MIT Technology Review*. (Oct 24, 2012). <http://www.technologyreview.com/featuredstory/429529/how-solar-based-microgrids-could-bring-power-to-millions/>
- ⁵²Blyden, B.K., and W.-J. Lee. “Modified Microgrid Concept for Rural Electrification in Africa.” *Power Engineering Society General Meeting*. IEEE. (2006). http://ieeexplore.ieee.org/xpls/abs_all.jsp?arnumber=1709540&tag=1
- ⁵³Kann, S., M.J. Shiao, S. Mehta, et al. *U.S. Solar Market Insight Report, 2013 Year-In-Review, Executive Summary*. GTM Research. (Mar 5, 2014). <http://www.greentechmedia.com/research/list/category/seia>
- ⁵⁴*International Energy Outlook 2013*. U.S. Energy Information Agency. DOE/EIA-0484(2013). (Jul 2013). [http://www.eia.gov/forecasts/archive/ieo13/pdf/0484\(2013\).pdf](http://www.eia.gov/forecasts/archive/ieo13/pdf/0484(2013).pdf)
- ⁵⁵Jacobson, M.Z., and M.A. Delucchi. “Providing All Global Energy with Wind, Water, and Solar Power, Part I: Technologies, Energy Resources, Quantities and Areas of Infrastructure, and Materials,” *Energy Policy* 39, 3 (2011): 1154-1169. <http://www.sciencedirect.com/science/article/pii/S0301421510008645>
- ⁵⁶*PVPS Report Snapshot of Global PV 1992-2013: Preliminary Trends Information from the IEA PVPS Programme*. International Energy Agency. Report IEA-PVPS T1-24 (2014). http://www.iea-pvps.org/fileadmin/dam/public/report/statistics/PVPS_report_-_A_Snapshot_of_Global_PV_-_1992-2013_-_final_3.pdf
- ⁵⁷Powers, D.S. “Solar Power Begins to Shine as Environmental Benefits Pay Off.” *New York Times*. (Nov 11, 2013). http://www.nytimes.com/2013/11/11/business/energy-environment/solar-power-begins-to-shine-as-environmental-benefits-pay-off.html?_r=0
- ⁵⁸*NY-BEST and DNV KEMA to Partner on Battery and Energy Storage Testing and Commercialization Center*. NY-BEST. (Jul 23, 2013). http://www.ny-best.org/sites/default/files/uploaded/images/NY-BEST_DNV_KEMA_Commercialization_Center_Partner_Announcement_7-15-13.pdf
- ⁵⁹*Advanced Research Projects Agency-Energy (ARPA-E) Project Database*. U.S. Department of Energy. <http://arpa-e.energy.gov/?q=projects/search-projects>
- ⁶⁰*Advanced Research Projects Agency-Energy (ARPA-E) FY 2015 Congressional Budget*. <http://arpa-e.energy.gov/sites/default/files/ARPA-E%20FY15%20Budget%20Request.pdf>

⁶¹*GRIDS: Grid-scale Rampable Intermittent Dispatchable Storage*. Advanced Research Projects Agency-Energy (ARPA-E): Projects. <http://arpa-e.energy.gov/?q=projects/search-projects>

⁶²*Innovation HUBS*. U.S. Department of Energy. <http://energy.gov/science-innovation/innovation/hubs>

⁶³*Joint Center for Energy Storage Research*. U.S. Department of Energy. www.jcesr.org

⁶⁴Crabtree, G. “The Joint Center for Energy Storage Research: A New Paradigm for Battery Research and Development,” *Physics of Sustainable Energy III: Using Energy Efficiently and Producing It Renewably*, edited by R.H. Knapp et al. AIP Conference Proceedings, in press. <http://arxiv.org/ftp/arxiv/papers/1411/1411.7042.pdf>

The hyperlinks in this document were active as of April 2015.

Appendix D – Concentrated Solar Power Models and Assumptions

This appendix provides details about the methods and assumptions used to simulate the performance of utility-scale concentrated solar power (CSP) plants as part of the analyses presented in Chapters 3 and 5 of this report. Our simulations used version 2014.1.14 of the System Advisor Model (SAM)¹ software. Developed by the U.S. Department of Energy’s National Renewable Energy Laboratory (NREL), SAM is non-commercial software and can be downloaded free of charge.¹

The two CSP systems simulated for this report use parabolic trough and solar tower technologies. Both types of systems and other CSP technologies are described in Chapter 3.

ASSUMPTIONS

Each of the two types of utility-scale CSP systems considered (i.e., parabolic trough and solar tower) was modeled in two locations: Daggett, California and Worcester, Massachusetts. Table D.1 summarizes the key assumptions applied in each of these four main cases.

Table D.1 Main Assumptions for Utility-Scale CSP Simulation Cases Using SAM

Case	Tower – CA	Tower – MA	Trough – CA	Trough - MA	Notes
Technology	Molten Salt Power Tower		Parabolic Trough		Physical model option in SAM is used for trough cases.
Location	Southern California (Daggett, CA)	Central Massachusetts (Worcester, MA)	Southern California (Daggett, CA)	Central Massachusetts (Worcester, MA)	
Financing option	Utility Independent Power Producer (IPP)				
Weather data source	SAM				Default SAM values for the two locations used.
Plant nameplate capacity	150 MW _{e,net}				Gross output is different for each case due to differences in factors such as parasitic loads.
Heat transfer fluid type	Salt (60% NaNO ₃ , 40% KNO ₃ by weight)		Therminol VP-1 (field fluid)		
Solar field configuration	External Receiver		Collector: Solargenix SGX-1 Receiver: Schott PTR 70 2008		Listed in SAM library.
Solar multiple	2.3	2.6	1.3	1.9	Solar multiple and storage hour values are optimized to minimize the levelized cost of electricity (LCOE) at each location (see Chapter 3 for further discussion).
Storage (full load hours)	11	8	0	1	
Thermal storage type	Two-Tank Direct				Where applicable.

Table D.1 Main Assumptions for Utility-Scale CSP Simulation Cases Using SAM

(continued)

Case	Tower – CA	Tower – MA	Trough – CA	Trough - MA	Notes
Power cycle conversion efficiency	43%				Though all cases assume the same conversion efficiency here, towers can achieve higher efficiencies than troughs because of their ability to reach higher working temperatures.
Boiler operating pressure	100 bar		100 bar		
Fossil boiler	Not considered				
Cooling system	Evaporative				
Plant availability	96%				
Annual decline in output	0				
Other technical specification	Default				SAM default values used for other plant technical specifications.
Cost basis	US\$ (2014)				SAM default spreadsheets used to estimate costs for trough and solar tower plants.
Time of delivery factors	TOD factors are used to simulate bid prices at each location				
Financial Parametersⁱ					
Minimum required IRR on equity:	Options considered: – 8% – 10% (base case) – 12%				See Chapter 5 for details.
Inflation rate	2.5%				Applied to power purchase agreement (PPA) price.
Debt fraction	60%				
Loan term	25 years				
Loan rate	7.5%				
Plant life time	25 years				Financial analysis period.
Real discount rate	5.85%				
Federal income tax rate	35%				
State Income Tax	8.84%	6.25%	8.84%	6.25%	
Sales Tax	8%	6.25%	8%	6.25%	
Annual insurance rate	0.5% of applicable installed cost				
Property Tax	0%				
Incentives	Options considered: – None (base case) – Investment Tax Credit (ITC): 30% (federal)				ITC reduces depreciation basis for federal and state taxes.
Depreciation	Options considered: – Base case: 15-yr Modified Accelerated Cost Recovery System (MACRS) (custom) – 5-yr MACRS (considered as subsidy/incentive)				See Chapter 5 for details.

ⁱThe data in this table were used to design the four CSP cases with SAM. For the financial analysis in Chapter 5, only the capital costs from these SAM simulations were used. Financial parameters in Chapter 5 are somewhat different than those used here.

TIME OF DELIVERY

Chapter 5 of this report discusses electricity pricing in competitive wholesale markets, including short-term changes in price connected with time of delivery (TOD). TOD factors were used to construct hourly market prices in the California and Massachusetts locations and are listed in Table D.2.

Tables D.3 and D.4 describe the weekday and weekend dispatch schedules used to construct

bid prices in the two locations considered for this study. The values shown in the tables correspond to TOD factors for a given period.

In all cases we assumed that heat stored in the energy storage system is dispatched as soon as it is needed; in other words, stored energy was dispatched as soon as the energy input to the turbine was less than turbine's nominal capacity. We do not consider the possibility that dispatch would be delayed to periods with higher bid prices.

Table D.2 TOD Factor Values Used to Construct Hourly Prices for Southern California and Central Massachusetts Locations

Location	Southern California	Central Massachusetts
TOD Factor 1	0.45	0.73
TOD Factor 2	0.68	0.64
TOD Factor 3	1.55	1.42
TOD Factor 4	1.18	1.22
TOD Factor 5	1.00	0.99
TOD Factor 6	0.81	0.82
TOD Factor 7	1.09	1.10
TOD Factor 8	0.92	0.89
TOD Factor 9	1.31	1.91

Table D.3 Dispatch Schedules Corresponding to TOD Factors (from Table D.2) Used to Construct Hourly Prices in the Southern California Location

Hour	0	1	2	3	4	5	6	7	8	9	10	11	12	13	14	15	16	17	18	19	20	21	22	23
Month	Weekdays																							
January	5	8	6	6	6	6	5	4	9	4	4	4	4	4	4	7	7	4	3	3	9	9	4	7
February	8	6	6	2	2	6	5	9	9	4	4	4	4	7	7	7	5	7	9	3	9	4	4	7
March	6	2	2	1	1	2	6	5	4	7	7	7	7	7	5	5	5	8	5	7	9	4	7	5
April	6	2	2	1	1	1	6	5	4	7	7	7	4	4	4	7	7	5	8	8	4	9	7	8
May	2	2	1	1	1	1	2	6	8	8	5	7	7	4	4	4	7	7	5	8	5	9	7	8
June	2	1	1	1	1	1	1	2	6	6	5	7	4	4	4	9	9	9	4	7	5	4	7	8
July	8	6	2	1	1	1	2	2	6	8	5	7	4	9	9	3	3	3	3	9	4	4	7	5
August	8	6	6	2	2	2	6	6	6	8	5	7	4	4	9	3	3	3	3	9	4	4	7	5
September	8	6	6	2	2	2	6	8	8	8	5	7	4	4	9	9	3	3	9	9	9	9	7	5
October	8	8	6	2	2	6	8	5	7	5	7	4	4	4	4	9	9	9	4	9	9	4	4	7
November	8	8	6	6	6	6	5	7	4	7	7	4	4	7	7	7	7	4	3	3	9	4	7	7
December	5	6	6	2	2	6	8	5	7	7	7	7	5	5	5	5	8	7	3	3	9	9	4	7
	Weekends																							
January	8	8	6	6	6	6	6	8	8	5	7	7	7	5	5	8	5	7	9	3	9	9	4	7
February	8	8	6	2	2	6	6	8	5	5	7	7	7	5	5	8	8	8	4	3	9	9	4	5
March	6	6	2	2	1	2	2	2	6	6	8	8	8	8	8	6	6	6	8	4	9	9	4	5
April	2	2	2	1	1	1	1	1	2	2	6	8	8	5	5	6	8	6	6	6	4	9	7	8
May	2	2	1	1	1	1	1	1	1	2	2	6	6	6	6	6	6	6	6	6	5	9	5	6
June	2	2	1	1	1	1	1	1	1	2	2	8	5	7	7	7	4	4	4	7	7	9	4	8
July	8	8	6	2	1	1	1	1	1	2	8	5	7	4	9	3	3	3	3	9	4	4	4	5
August	6	6	6	2	2	2	2	1	2	2	6	8	5	7	4	9	9	9	9	4	7	4	5	8
September	8	8	6	6	2	2	6	2	2	6	8	5	7	7	4	9	9	9	9	9	9	9	7	5
October	8	5	8	6	6	6	6	6	6	8	8	5	7	7	7	7	7	4	4	9	3	9	7	5
November	8	8	6	6	6	6	6	6	8	8	5	5	5	5	5	8	8	7	3	3	9	4	7	7
December	5	8	6	6	6	6	6	8	8	5	7	7	7	5	8	8	8	7	3	3	3	9	4	7

Table D.4 Dispatch Schedules Corresponding to TOD Factors (from Table D.2) Used to Construct Hourly Prices in the Central Massachusetts Location

Hour	0	1	2	3	4	5	6	7	8	9	10	11	12	13	14	15	16	17	18	19	20	21	22	23
Month	Weekdays																							
January	7	5	5	5	5	7	3	3	3	3	3	3	3	4	4	4	3	9	9	3	3	4	4	7
February	8	6	6	6	6	8	4	4	4	4	4	7	7	7	5	5	7	3	3	4	4	7	5	8
March	2	2	2	2	2	1	8	5	5	5	5	5	8	8	6	6	6	5	7	4	5	6	1	1
April	2	2	2	2	2	2	6	8	8	5	5	5	5	5	8	8	8	8	6	5	5	6	1	1
May	1	2	2	2	2	2	1	8	8	5	7	7	7	7	7	7	7	7	5	5	7	8	6	1
June	6	1	2	2	2	1	6	8	5	5	7	4	4	3	3	3	3	4	4	7	7	5	8	6
July	8	6	1	1	1	1	6	5	5	4	3	3	9	9	9	9	9	9	3	3	3	4	5	8
August	6	1	1	2	1	1	6	8	8	5	7	4	3	3	3	3	3	3	4	4	4	5	8	6
September	1	1	2	2	2	1	6	6	8	5	7	7	7	4	4	4	4	7	7	4	5	8	6	1
October	1	2	2	2	2	1	8	8	8	5	5	5	5	5	8	8	8	5	4	7	5	6	1	1
November	8	6	6	6	6	8	7	7	7	7	7	7	7	7	5	5	4	3	3	4	7	5	5	8
December	8	8	6	6	8	5	7	4	4	4	4	4	7	7	7	7	3	9	3	3	4	7	7	5
	Weekends																							
January	4	7	7	5	5	5	7	7	4	3	3	3	4	4	4	4	3	9	9	3	3	3	4	4
February	8	6	6	6	6	6	6	8	5	7	7	7	5	5	8	8	5	3	3	4	7	5	8	8
March	1	2	2	2	2	2	1	1	6	6	8	8	6	1	1	1	1	6	5	7	5	6	1	1
April	2	2	2	2	2	2	2	2	1	6	8	8	6	6	1	1	1	6	6	5	5	6	1	1
May	1	2	2	2	2	2	2	2	1	6	8	8	8	8	8	8	8	5	8	5	7	8	6	1
June	1	1	2	2	2	2	2	1	6	6	8	5	5	5	5	5	5	5	5	8	5	8	6	6
July	8	6	6	1	1	1	1	6	8	5	7	7	4	3	3	3	3	3	4	7	4	7	5	8
August	6	6	1	1	1	1	1	1	6	8	5	7	7	7	7	4	4	4	7	7	7	5	8	6
September	1	1	2	2	2	2	2	1	1	6	8	8	8	8	8	8	5	8	5	7	5	6	1	1
October	1	1	2	2	2	2	1	1	6	8	8	8	8	8	6	6	8	5	7	7	5	8	6	1
November	8	6	6	6	6	6	8	8	5	5	5	5	5	8	8	8	7	3	4	7	7	5	8	8
December	5	8	8	6	6	8	8	5	7	7	7	7	7	5	5	5	4	3	3	4	4	7	7	5

Figure D.1 Effect of Plant Size on Installed Cost and Levelized Cost of Electricity (LCOE)

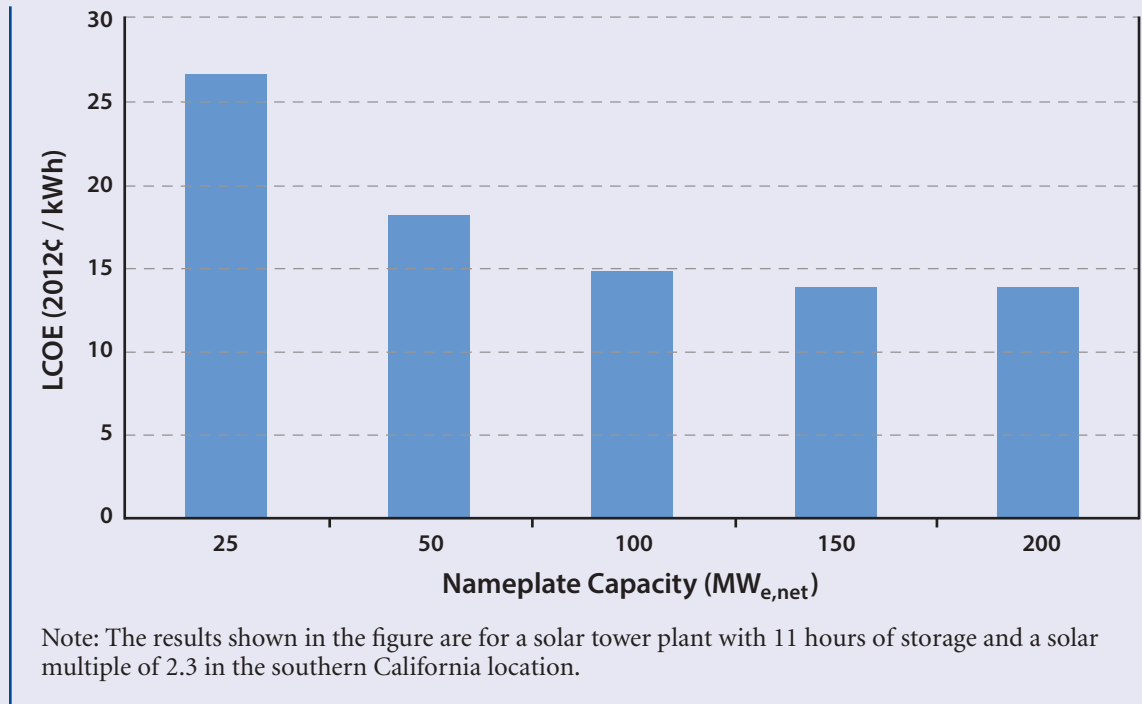

PLANT SIZE

The term “economy of scale” refers to the cost advantage that can be obtained by increasing the size, throughput, or scale of a plant and thereby reducing the cost per unit of output. As for most industrial plants, economies of scale play a vital role in determining the optimum size of a CSP plant. The impact of plant size on LCOE is illustrated in Figure D.1 for the California solar tower plant example.

COMPARISON OF TOTAL INSTALLED COSTS OF TROUGH AND SOLAR TOWER TECHNOLOGIES

Figure D.2 compares the breakdown of total installed costs for the Trough-CA and Tower-CA cases. Total installed costs for Trough-CA and Tower CA are estimated to be \$790 million and \$1,070 million, respectively. Total installed cost for the Tower-CA case includes the cost of the thermal storage system.

Figure D.2 Breakdown of Capital Costs for Parabolic Trough and Solar Tower Technologies (in dollars per watt capacity)

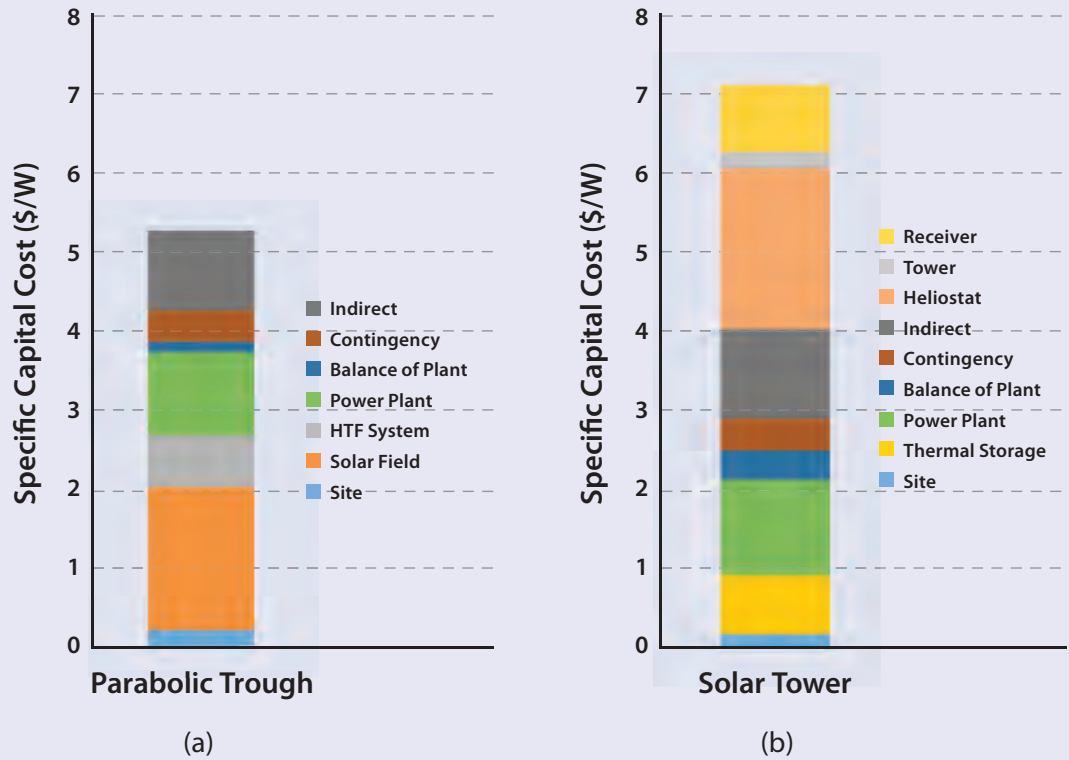

Note: Assumed location for both cases is Daggett, CA; plant size is 150 MW_{e,net}; no storage included in the parabolic trough case; 11 hours of thermal storage included in the solar tower case.

REFERENCE

“System Advisor Model (SAM),” National Renewable Energy Laboratory, <https://sam.nrel.gov/>.

The hyperlink in this document was active as of April 2015.

Appendix E – Methods and Assumptions Used in Chapter 5

This appendix provides further detail on the methods employed and assumptions made in the analysis of Chapter 5.

THE LEVELIZED COST OF ELECTRICITY

The levelized cost of electricity (LCOE) is defined as the charge per kilowatt-hour (kWh) that equates the discounted present value of revenues to the discounted present value of costs, including the initial capital investment and annual operating costs as well as any future replacement capital costs incurred over the life of a facility. These costs include taxes paid. For example, for a solar project running for 25 years with installation over the year prior, let $t=0,1,2\dots25$. Write the annual capital investment as K_t , the annual operating and maintenance expenditures as O_t , the annual taxes paid as V_t , all denominated in \$/year, and the annual output schedule as Q_t , denominated in megawatts per year (MW/year). Then the LCOE is defined implicitly by this formula:

$$\sum_{t=0}^{25} \frac{LCOE Q_t}{(1+R)^t} = \sum_{t=0}^{25} \frac{K_t + O_t + V_t}{(1+R)^t},$$

where R is the cost of capital, which is discussed in more detail below.¹

Rearranging the formula gives an explicit definition:

$$LCOE = \frac{\sum_{t=0}^{25} \frac{K_t + O_t + V_t}{(1+R)^t}}{\sum_{t=0}^{25} \frac{Q_t}{(1+R)^t}}.$$

The LCOE may be reported as either a real LCOE or a nominal LCOE. In calculating a real LCOE, the values of all of the cash flow inputs — K_t , O_t , and V_t — must be real, i.e., with any inflation factor removed. Since tax calculations, such as depreciation charges, are inherently nominal, care must be taken to be sure that the tax cash flows have been correctly adjusted to remove the inflation factor properly. The cost of capital must also be a real cost of capital. The U.S. Energy Information Administration (EIA) reports real LCOEs in its *Annual Energy Outlook*.³ In calculating a nominal LCOE, the values of all cash flow inputs must be nominal — i.e., with inflation included. The cost of capital must also be a nominal cost of capital. The U.S. Department of Energy’s National Renewable Energy Lab (NREL) reports both real and nominal LCOEs as an output of its System Advisor Model (SAM).¹ In general, with positive inflation, a nominal LCOE will be higher than a real LCOE.

¹See, for example, NREL¹ and Short, Packey, and Holt.²

The traditional LCOE, whether real or nominal, is fixed throughout the life of the project — as indicated by the term “levelized.” However, in calculating a nominal LCOE, all other costs are understood to be increasing with inflation. An alternative definition of the nominal LCOE recognizes that the charge may be escalated at the inflation rate, I , and reports the first year’s charge. This is comparable to reporting the first-year price of a power purchase agreement that includes a clause increasing the annual price for the rate of inflation, as NREL’s SAM does. This LCOE is defined implicitly by the formula:

$$\sum_{t=0}^{25} \frac{LCOE_1 (1+I)^t Q_t}{(1+R)^t} = \sum_{t=0}^{25} \frac{K_t + O_t + V_t}{(1+R)^t}$$

Rearranging the formula gives an explicit definition:

$$LCOE_1 = \frac{\sum_{t=0}^{25} \frac{K_t + O_t + V_t}{(1+R)^t}}{\sum_{t=0}^{25} \frac{(1+I)^t Q_t}{(1+R)^t}}$$

Although this calculation is executed in nominal dollars, it is comparable to a real LCOE because the charge escalates with inflation from the base value. This is the LCOE we report in Chapter 5.

COST OF CAPITAL

A key input in calculating the levelized cost of electricity is the discount rate applied to cash flows in different years. For our central case we employ a weighted average cost of capital (WACC) that is calculated using a 7.5% cost of debt, a 10% cost of equity, and a 60% debt ratio. We assume a marginal federal corporate income tax rate of 35% and, for California, a marginal state corporate tax rate of 8.84%. This yields a combined state and federal corporate tax rate of 40.75%, which gives us a WACC of 6.67%:

$$WACC = \frac{D}{V} R_D (1 - \tau_C) + \frac{E}{V} R_E = 60\% \times 7.50 \times 59.25\% + 40\% \times 10\% = 6.67\%$$

For Massachusetts, we assume a corporate income tax rate of 8% so that the WACC is 6.69%. These are all nominal discount rates, to be applied to cash flows that reflect anticipated inflation. We assume the corresponding inflation rate is 2.5%, which is the rate we apply to the various cash flows in our calculation.

The WACC should be applied to the solar project’s unlevered net cash flow after taxes, i.e., not taking into account the project’s interest tax shields. This is because the benefits of the interest tax shield show up through the use of an after-tax cost of debt in the formula. Applying the WACC to cash flows that already

reflect interest tax shields double counts the tax benefits of debt. All tax shields other than interest tax shields — such as depreciation tax shields — are included in the cash flows to which the WACC is applied.ⁱⁱ

This cost of capital is appropriate for a power generator operating in a competitive wholesale market without any assured rate of return — i.e., a “merchant model.” Many solar projects are financed using a power purchase agreement (PPA) sold to a utility, whether regulated or operating in competitive wholesale markets. The PPA shifts price risk from the power generator to the power purchaser. This would then mean that the project’s revenue is less

risky and should be discounted by a lower rate. Of course, the price negotiated as part of a PPA will reflect the cost of shifting this risk, so that the net value of the stream of revenue should remain roughly the same. In any case, the PPA does not affect the cost of producing the power — hence we do not reflect the lower risk of PPAs in our calculation of LCOE.

We also use this cost of capital for the residential PV system, which would be appropriate for the third-party ownership model in which the tax and financial position of the corporate owner is like that of the corporate owner of a utility-scale PV system.

ⁱⁱAn alternative would be to employ the cash flows after tax, including the interest tax shields along with all others. In this case, it is appropriate to use a weighted average with the before-tax cost of debt, which gives us a cost of capital of 8.50%:

$$R_A = \frac{D}{V} R_D + \frac{E}{V} R_E = 60\% \times 7.50 + 40\% \times 10\% = 8.50\% .$$

REFERENCES

¹NREL System Advisor Model (SAM): Levelized Cost of Energy (LCOE). National Renewable Energy Laboratory. https://www.nrel.gov/analysis/sam/help/html-php/index.html?mtf_lcoe.htm

²Short, W., D. J. Packey, and T. Holt. *Manual for the Economic Evaluation of Energy Efficiency and Renewable Energy Technologies*. National Renewable Energy Laboratory. NREL/TP-462-517. (March 1995). <http://www.nrel.gov/docs/legosti/old/5173.pdf>

³*Levelized Cost of New Generation Resources in the Annual Energy Outlook 2013*. U.S. Energy Information Administration. (January 2013). http://www.eia.gov/forecasts/aeo/er/pdf/electricity_generation.pdf

The hyperlinks in this document were active as of April 2015.

Appendix F – Background Material for Chapter 8

The simulations discussed in Chapter 8 of this report, concerning the integration of solar electricity generation with wholesale electricity markets, focused on a particular year (2030) and used a single set of assumptions for projected electricity demand, fuel costs, and installed generation mix (for a medium-term time frame). This appendix briefly summarizes the data used.

ASSUMPTIONS FOR THE ERCOT-LIKE SYSTEM

- For hourly load in 2030, we assumed the reference annual profile based on hourly demand in 2011 and 2012. The profile was downloaded from the Electric Reliability Council of Texas (ERCOT) website.¹ To scale the profile to the year 2030, we assumed a constant rate of growth in demand of 1% per year.
- Wind and solar profiles likewise use 2012 data from the ERCOT website¹ (Planning and Operations Information). The profiles were scaled in proportion to the installed solar capacity being simulated. Installed wind capacity in 2030 was assumed to total 15 GW.
- Assumptions concerning the already installed generation mix for both the medium- and long-term scenarios are shown in the figure below, which uses data published by the U.S. Energy Information Administration (EIA).²

Figure F.1 Installed Capacity for the ERCOT-Like System²

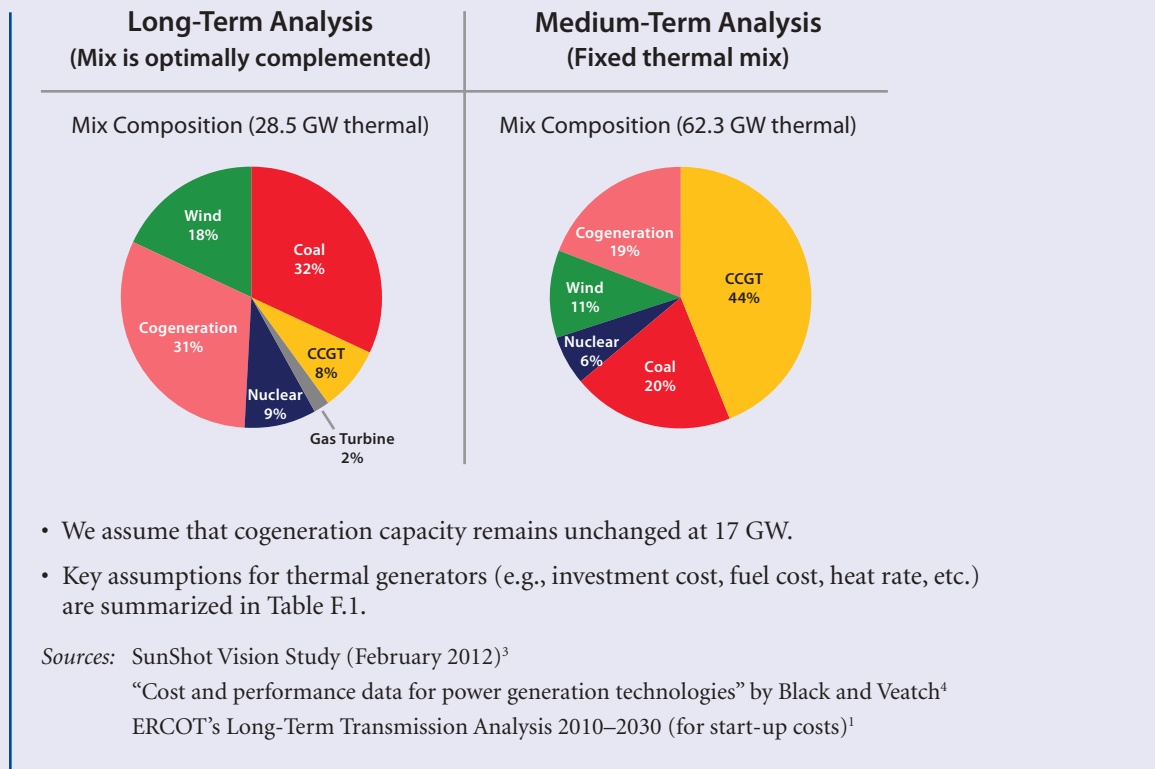

Table F.1 Assumptions for Thermal Generators in the ERCOT-Like System⁴

Technology	Heat Rate [Mbtu/MWh]	Fuel Cost [\$/Mbtu]	Energy Fuel Cost [\$/MWh]	Variable O&M [\$/MWh]	Total Variable [\$/MWh]	Overnight Capital Cost [k\$/MW]	Economic Life [years]	Rate of Return [%]	Annualized Capital Cost [k\$/MW]
CCGT	7	8	56	5	61	1,200	20	10,2	142,88
CGT	10	8	80	30	110	660	20	10,2	78,58
Coal	9	2	18	4	22	2,900	20	10,2	345,29
Nuclear	10	1	10	0	10	6,200	20	10,2	738,21

ASSUMPTIONS FOR THE CALIFORNIA-LIKE SYSTEM

- For hourly load in 2030, we assumed the reference annual profile based on hourly demand in 2011. The profile was taken from the California Independent System Operator (ISO) Open Access Same-time Information System (OASIS).⁵ To scale the profile to the year 2030, we assumed a constant rate of growth in demand of 1% per year.
- Wind and solar production profiles were obtained from the daily California ISO Renewables Watch.⁶
- For hydro units, we used historical production data profiles to estimate relevant input parameters such as maximum output, run-of-the-river capacity, and maximum energy available in each period.⁶
- For thermal generators, we assumed the same characteristics as in our simulations for the ERCOT-like system (see Table F1).
- In the long-term scenario, the already installed generation mix is assumed to include 10 GW of wind, 8.5 GW of cogeneration, and 7.95 GW of thermal capacity (Figure F2).

Figure F.2 Installed Capacity for the California-Like System (Long-Term Analysis)²

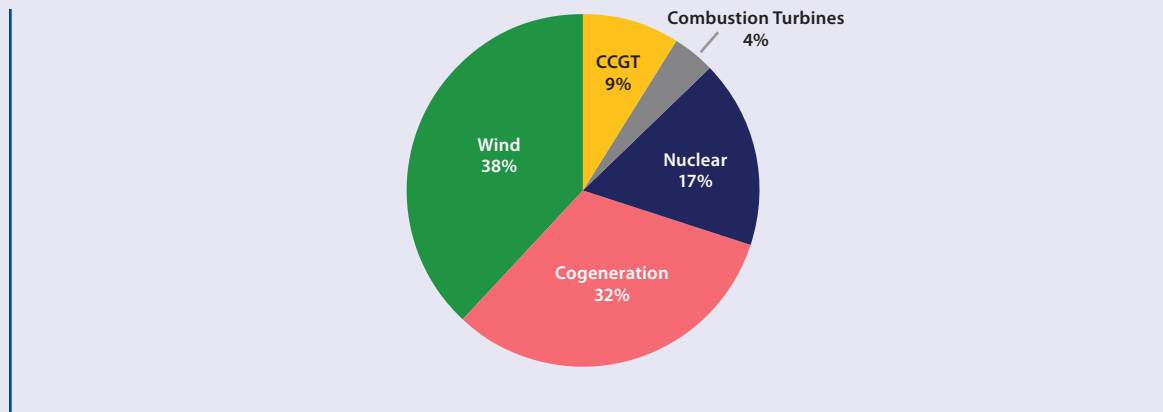

REFERENCES

- ¹Electric Reliability Council of Texas (ERCOT). www.ercot.com
- ²*Form EIA-860 Detailed Data: Year 2012*. U.S. Energy Information Administration. <http://www.eia.gov/electricity/data/eia860/>
- ³Margolis, R., C. Coggeshall, and J. Zuboy. *SunShot Vision Study*. U.S. Department of Energy. NREL Report No. BK-5200-47927; DOE/GO-102012-3037. (Feb 2012). <http://www1.eere.energy.gov/solar/pdfs/47927.pdf>
- ⁴*Cost and Performance Data for Power Generation Technologies*. Prepared by Black and Veatch for the National Renewable Energy Laboratory (Feb 2012). <http://bv.com/docs/reports-studies/nrel-cost-report.pdf>
- ⁵Open Access Same-time Information System (OASIS). California ISO. <http://oasis.caiso.com/mrioasis>
- ⁶Renewables Watch. California ISO. <http://www.caiso.com/green/renewableswatch.html>

The hyperlinks in this document were active as of April 2015.



Acronyms and Abbreviations

ABS	Asset-backed securities	EPIA	European Photovoltaic Industry Association
ac	Alternating current	EPRI	Electric Power Research Institute
AM0/1/1.5	Air mass 0/1/1.5	EPS	Electric power system
AMI	Advanced metering infrastructure	EQE	External quantum efficiency
ARPA-E	Advanced Research Projects Agency–Energy	ERCOT	Electric Reliability Council of Texas
ARRA	American Recovery and Reinvestment Act of 2009	ESS	Energy storage system
a-Si	Amorphous silicon	EU	European Union
a-Si:H	Hydrogenated amorphous silicon	EV	Electric vehicle
a-SiGe	Amorphous silicon-germanium	FMV	Fair market value
ASTM	American Society for Testing and Materials	GDP	Gross domestic product
BIPV	Building-integrated PV	HIT	Heterojunction with intrinsic thin layer
BOS	Balance of system	HTF	Heat transfer fluid
CAES	Compressed air energy storage	IC	Integrated circuit
CAISO	California Independent System Operator	IEA	International Energy Agency
CCGT	Combined cycle gas turbine	IEEE	Institute of Electrical and Electronics Engineers
CdTe	Cadmium telluride	IPCC	Intergovernmental Panel on Climate Change
CEC	California Energy Commission	IPP	Independent power producer
CEMS	Customer energy management service	ISCCS	Integrated solar combined cycle system
CF	Capacity factor	ISO	Independent system operator
CGT	Combustion gas turbine	ITC	Investment tax credit
CHP	Combined heat and power	ITO	Indium tin oxide
CIGS	Copper indium gallium diselenide (CuIn _x Ga _{1-x} Se ₂)	ITRPV	International Technology Roadmap for Photovoltaic
CSG	Crystalline silicon on glass	JCESR	Joint Center of Energy Storage Research (DOE)
c-Si	Crystalline silicon	LACE	Levelized avoided cost of energy
CSP	Concentrated solar power	LCOE	Levelized cost of energy
CZTS	Copper zinc tin sulfide (Cu ₂ ZnSnS ₄)	LED	Light-emitting diode
dc	Direct current	LEEMA	Low Emissions Electricity Market Analysis
DG	Distributed generation	LLC	Limited liability company
DNUoS	Distribution network use of system	LPO	Loan Program Office
DOD	Department of Defense	LSE	Load-serving entity
DOE	Department of Energy	MACRS	Modified Accelerated Cost Recovery System
DSIRE	Database of State Incentives for Renewables and Efficiency	mc-Si	Multicrystalline silicon
DSSC	Dye-sensitized solar cell	MLP	Master limited partnership
EERE	Office of Energy Efficiency and Renewable Energy	NERC	North American Electric Reliability Corporation
EIA	Energy Information Administration		

NGCC	Natural gas combined cycle	REC	Renewable energy certificate
NPC	Net present cost	REIT	Real estate investment trust
NREL	National Renewable Energy Laboratory	RNM	Reference network model
NSRDB	National Solar Radiation Database	RPS	Renewable portfolio standard
NY-BEST	New York Battery and Energy Storage Technology Consortium	SAM	System Advisor Model
OECD	Organization for Economic Co-operation and Development	sc-Si	Single-crystalline silicon
OPV	Organic photovoltaics	SEGS	Solar Energy Generating Systems (California)
PET	Polyethylene terephthalate	WWSEIA	Solar Energy Industries Association
PF	Power factor	SETO	Solar Energy Technology Office
PG&E	Pacific Gas & Electric	SF	Storage factor
PHES	Pumped heat energy storage	SREC	Solar renewable energy credit
PII	Permitting, interconnection, and inspection	T&D	Transmission and distribution
PPA	Power purchase agreement	TES	Thermal energy storage
PURPA	Public Utility Regulatory Policy Act (1978)	TMY	Typical meteorological year
PV	Photovoltaic	TOD	Time of delivery
QD	Quantum dot	USGS	U.S. Geological Survey
QDPV	Quantum dot photovoltaics	V2G	Vehicle-to-grid
R&D	Research and development	VER	Variable energy resource
RD&D	Research, development, and demonstration	WACC	Weighted average cost of capital
		WEO	World Energy Outlook
		Wp	Watts peak
		WTP	Willingness to pay

List of Figures

Figure 1.1	Worldwide Distribution of the Solar Resource	5
Figure 1.2	Complete Solar Irradiance Profile in Golden, Colorado for the Year 2012.	6
Figure 1.3	Solar PV.	8
Figure 1.4	Solar CSP.	9
Figure 2.1	Solar PV Energy Conversion	22
Figure 2.2	Current Solar PV Device Structures	23
Figure 2.3	Trends in Record Lab-Cell Power Conversion Efficiencies.	27
Figure 2.4	Solar Cell Thickness by Technology Classification	28
Figure 2.5	Limited Utility of Generational Classification Scheme.	31
Figure 2.6	Alternative PV Technology Classification Scheme Based on Material Complexity	33
Figure 2.7	Materials Usage, Abundance, and Cost for Key Elements Used in Commercial and Emerging PV Technologies	37
Figure 2.8	Key Metrics for Photovoltaic Technologies Ordered by Material Complexity	38
Figure 3.1	Distribution of CSP-Suitable Land and Associated Solar Insolation Across the Southwestern United States.	50
Figure 3.2	Efficiency of a Typical CSP Plant	52
Figure 3.3	Parabolic Trough CSP Design	53
Figure 3.4	Solar Tower CSP Design	54
Figure 3.5	Schematic Diagram and Picture of a Solar Beam-Down CSP Design.	56
Figure 3.6	Linear Fresnel Collector Design	57
Figure 3.7	Stirling Dish Engine System	58
Figure 3.8	Process Flow Diagram for a CSP System with a Two-Tank Indirect Energy Storage System and Fossil-Fuel Backup Boiler	60
Figure 3.9	Use of Thermal Energy Storage in a CSP Plant	61
Figure 3.10	Effect of Solar Multiple and Storage Size on LCOE of a CSP Tower Plant	62
Figure 3.11	Integrated Solar Combined Cycle System	67
Figure 3.12	Direct Solar-to-Salt Design	68
Figure 3.13	Combined Open-Air Brayton Cycle with Natural Gas Peaking Capability	69
Figure 4.1	Cumulative Grid-Connected PV Capacity by State	77
Figure 4.2	Annual U.S. PV Installations by Market Segment.	78
Figure 4.3	Evolution of PV Module Prices in the United States from 2008 to 2014	79
Figure 4.4	Average U.S. Prices for Residential and Utility-Scale PV Systems	80
Figure 4.5	Histogram of Reported Residential PV Prices in California for 2010 and 2013.	81
Figure 4.6	Relative Contribution of BOS Costs to Overall Prices for Residential and Utility-Scale PV Systems	82
Figure 4.7	Stair Step Build-Up of Estimated Costs for a Utility-Scale PV System	84
Figure 4.8	Stair Step Build-Up of Estimated Costs for a Residential PV System	85
Figure 4.9	Impact of Federal Subsidies on the Effective Cost of Utility-Scale PV	87
Figure 4.10	Distribution of Reported Prices for Residential Direct Sale and Third-Party-Owned PV Systems in California (2013 data)	90
Figure 4.11	Cost, Subsidy, and Pricing in Residential Installations: Direct Sale.	91
Figure 4.12	PV Prices under the Leasing Model of PV Sales	92

Figure 4.13	Impact of Method Used for Cost Basis Calculation on Income Potential of a Third-Party-Owned Solar System	95
Figure 4.14	Non-Hardware BOS Costs in U.S. and German Residential PV Markets (2013 data)	97
Figure 5.1	Summertime Hourly Electricity Wholesale Price Relative to Seasonal Average Price in Germany 2006–2012 . . .	106
Figure 5.2	Value Ratio for Solar Generation in Germany with Changing Market Share	107
Figure 5.3	Summary of Levelized Cost of Electricity Results	118
Figure 6.1	Solar Capacity Growth and Costs Compared to Projections	127
Figure 6.2	Land Requirements for Large-Scale PV Deployment Compared to Existing Land Uses	130
Figure 6.3	Commodity Materials Requirements for Large-Scale Deployment of Current PV Technologies (Primarily Silicon)	131
Figure 6.4	Critical Materials Requirements for Large-Scale Deployment of Different PV Technologies	135
Figure 6.5	Materials Requirements for Large-Scale Deployment of Energy Storage Based on Various Electrochemical Battery Technologies	137
Figure 6.6	Cost versus Production for a Hypothetical Energy-Critical Element	140
Figure 6.7	Historic Data on Production Growth for Different Metals Compared to Required Growth Rates for PV-Critical Elements	141
Figure 6.8	Total Consumption of Critical Materials for Commercial PV Technologies as a Function of Total Deployment	145
Figure 7.1	Examples of Load Profiles	155
Figure 7.2	Extreme Net-Load Scenarios for a Customer with a PV Generator	156
Figure 7.3	Average Daily Insolation Map of the United States and Selected Locations for Network Simulation	159
Figure 7.4	Procedure for Designing a Base Network	160
Figure 7.5	Total Network Cost after the Introduction of PV Generators	162
Figure 7.6	Annual Network Losses after the Introduction of PV Generators	163
Figure 7.7	Daily Load and PV Generation Profiles for Two Networks with High PV Penetration	164
Figure 7.8	The Effect of Different Levels of PV Penetration	165
Figure 7.9	Total Incremental Annual Network Costs Divided by the Amount of Installed PV Capacity, as a Function of the PV Energy Share	166
Figure 7.10	Disaggregated Network Costs	167
Figure 7.11	Modification of Net Load for Different Energy Storage Factors (SF)	169
Figure 7.12	Contribution of Energy Storage to the Integration of Distributed PV Generation	169
Figure 7.13	Effect of Volumetric Tariff under Net-Metering for the Des Moines Host Network	171
Figure 8.1	ERCOT Net Load for a Typical Summer Day at Different Levels of Solar PV Penetration	177
Figure 8.2	Net Load for Different Penetration Levels of Solar PV in Winter and Summer in the United Kingdom	178
Figure 8.3	Hourly Net Load Ramps for Different Levels of Solar PV Penetration	179
Figure 8.4	Impact on System Operation Regimes as Solar PV Penetration Increases (Summer and Winter)	182
Figure 8.5	Economic Curtailment of Zero-Variable-Cost Energy	184
Figure 8.6	Annual Electricity Production as a Function of Installed Solar PV Capacity	185
Figure 8.7	Changes in Total Short-Term Thermal Costs as a Consequence of Solar PV Penetration	186
Figure 8.8	Evolution of Average Market Prices	187
Figure 8.9	Evolution of Peak Prices Due to Increasing Solar Penetration	188
Figure 8.10	Price-Duration Curves for Two Scenarios of Solar Penetration	188
Figure 8.11	Average Market Prices and Average Prices as Perceived by Owners of Solar Generation	189
Figure 8.12	Operational Impact of Hydro Resources in the California-Like System	191

Figure 8.13	Evolution of Installed Capacity and Annual Production by Technology (ERCOT-Like System)	193
Figure 8.14	Evolution of Installed Capacity and Corresponding Annual Energy Production (California-Like System)	194
Figure 8.15	Capacity Value of Solar PV in the ERCOT and California Systems	194
Figure 8.16	Changes in Long-Term (Thermal) Production Costs as a Consequence of Solar PV Penetration (ERCOT-Like System)	195
Figure 8.17	Evolution of Average Wholesale Market Prices	195
Figure 8.18	Price-Duration Curves for Two Scenarios of Solar Penetration (ERCOT-Like System)	196
Figure 8.19	Price-Duration Curves for Two Levels of PV Penetration (California-Like System)	197
Figure 8.20	Annual Production by Technology Type with and without Solar Production Subsidies	198
Figure 8.21	Dispatch of CSP with Storage Capability in Two PV Penetration Scenarios	199
Figure 8.22	Impact of Energy Storage on the Hourly Dispatch of Different Generation Resources	201
Figure 8.23	Market Remuneration for Solar PV Production (in \$/W) as a Function of PV Penetration and Energy Storage Capability	202
Figure 10.1	U.S. Department of Energy Support for Solar Technology Research (1974–2016)	232
Figure 10.2	Budget Breakdown for DOE’s Solar Energy Technologies Office	234
Figure 10.3	Breakdown of SETO Funding by Type of Recipient for FY2013	235
Figure 10.4	Effect of Module Efficiency on the Cost of a Crystalline Silicon PV System	239
Figure 10.5	Effect of Development Time on Record Efficiencies of Solar Cells and Modules	242
Figure A.1	Reduction in Average Solar Power Density from Different Factors	254
Figure A.2	The Solar Spectrum (a) and the Influence of Atmospheric Effects on the Earth’s Radiative Energy Balance (b)	255
Figure A.3	Incident Solar Radiation, Effect of Seasonal Variation (a), and Effect of Atmospheric Attenuation (b)	256
Figure A.4	Effects of Latitude on Daily and Yearly Insolation	257
Figure A.5	Irradiance Profiles at the Earth’s Surface on a Cloudless Day	257
Figure A.6	Complete Solar Irradiance Profile in Golden, Colorado for the Year 2012.	259
Figure A.7	Irradiance Profiles at Four Sites in the Denver Area	260
Figure A.8	Daily Irradiance and Monthly Insolation Profiles for Different Solar Panel Arrangements	261
Figure A.9	Insolation Maps for the United States	262
Figure A.10	Geographic and Seasonal Variability in Insolation for Specific U.S. Cities	263
Figure A.11	Worldwide Distribution of the Solar Resource	264
Figure A.12	Power Conversion Losses for Solar PV	265
Figure A.13	Direct Normal Solar Insolation across the United States	267
Figure B.1	Forms of Energy and Energy Conversion Processes	272
Figure B.2	The Electromagnetic Spectrum	273
Figure B.3	Energy Band Structure of Metals, Semiconductors, and Insulators	276
Figure B.4	Physical Structure and Electric Properties of a pn-Junction Diode	277
Figure B.5	Energy Bands during Operation of a pn-Junction Diode	278
Figure B.6	Representative Current–Voltage Characteristics of a Solar Cell	278
Figure B.7	Operation of a Solar Cell under Illumination and Interaction of Light with a Light-Absorbing Semiconductor.	279
Figure B.8	Solar Photon Flux at the Earth’s Surface and Normalized EQE Spectra for Different Types of Solar Cells	281
Figure B.9	Schematic Representation of a Solar Cell, a Solar Module, and a Solar Array	282
Figure C.1	Grid-Related Energy Storage Technologies Deployed or in the Demonstration Phase	289
Figure C.2	ESS Technologies and Associated Applications	294
Figure C.3	Global Solar-Related Energy Storage Capacity by Technology	295

Figure C.4 Total U.S. PV Installations from 2000 to 2012, Disaggregated by Installation Scale297

Figure C.5 Active ARPA-E Stationary Energy Storage Projects (as of December 2014)299

Figure D.1 Effect of Plant Size on Installed Cost and Levelized Cost of Electricity (LCOE)310

Figure D.2 Breakdown of Capital Costs for Parabolic Trough and Solar Tower Technologies
(in dollars per watt capacity)311

Figure F.1 Installed Capacity for the ERCOT-Like System317

Figure F.2 Installed Capacity for the California-Like System (Long-Term Analysis)318

List of Tables

Table 1.1 Estimated LCOEs for New Generation Resources in 201911

Table 3.1 Total Available Land Area and Corresponding Capacity Potential for CSP in the Southwestern United States50

Table 3.2 Advantages and Disadvantages of Various CSP Technologies64

Table 3.3 Recent Utility-Scale Solar Power Plants Commissioned in the United States65

Table 5.1 The Levelized Cost of Electricity for Three Hypothetical Solar Installations in Two Different Locations
under Alternative Assumptions119

Table 6.1 Abundance and Cumulative Production of PV-Critical Elements133

Table 6.2 Production Volume and Monetary Value of PV-Critical Elements Produced as Byproducts,
Relative to Parent Products138

Table 7.1 Reference Locations for Prototype Networks160

Table 7.2 Network Parameters Considered in the Simulation Analysis161

Table B.1 Bandgaps of Various Materials276

Table C.1 Key Characteristics of Storage Systems for Selected Energy Services
(Adapted from International Energy Agency).....286

Table C.2 Comparison of ESS Attributes and Associated Deployment Constraints and Challenges293

Table D.1 Main Assumptions for Utility-Scale CSP Simulation Cases Using SAM305

Table D.2 TOD Factor Values Used to Construct Hourly Prices for Southern California and Central
Massachusetts Locations307

Table D.3 Dispatch Schedules Corresponding to TOD Factors (from Table D.2) Used to Construct Hourly Prices
in the Southern California Location308

Table D.4 Dispatch Schedules Corresponding to TOD Factors (from Table D.2) Used to Construct Hourly Prices
in the Central Massachusetts Location309

Table F.1 Assumptions for Thermal Generators in the ERCOT-Like System318

Glossary

Air mass (AM)	A metric for the degree of atmospheric attenuation of solar radiation, based on the relative path length through the Earth's atmosphere. The air mass index at the Earth's surface is calculated as $1/\cos(\phi)$, where ϕ is the zenith angle ($\phi = 0$ when the Sun is directly overhead). Air mass 0 (AM0) refers to the solar spectrum outside the Earth's atmosphere. Air mass 1.5 (AM1.5) — corresponding to $\phi = 48.2^\circ$ — is commonly used to refer to the standard spectrum at a typical latitude at the Earth's surface.
Amorphous silicon	A disordered, non-crystalline form of silicon that absorbs light more strongly than crystalline silicon and can be deposited as a thin film at relatively low temperatures to form thin-film photovoltaic cells on glass, metal, or plastic substrates. Modern amorphous silicon cells are based on hydrogenated amorphous silicon (a-Si:H) and often employ multiple stacked junctions.
Anion	A negatively charged atom or group of atoms. Anions are attracted to the anode (positive electrode) in an electrolysis reaction.
Balance-of-system (BOS)	All components of an installed solar PV system besides PV modules. This term typically includes both hardware (e.g., inverter, transformer, wiring, and racking) and non-hardware (e.g., installation labor, customer acquisition, permitting, inspection, interconnection, sales tax, and financing) costs.
Bandgap	Fundamental property of semiconducting materials that determines the minimum energy (maximum wavelength) of light that can be absorbed, in units of electron-volts (eV). Direct-bandgap materials (e.g., GaAs, CdTe, and PbS) absorb light much more effectively than indirect-bandgap materials (e.g., Si), reducing the required absorber thickness.
Batch-based fabrication	A manufacturing paradigm based on parallel processing of a group of identical items. Each process step takes place at the same time for an entire group of items, and none of the items in the batch moves on to the next manufacturing step until the previous step is complete.
Blackbody radiation	A type of electromagnetic radiation within or surrounding a body in thermodynamic equilibrium with its environment, or emitted by a blackbody (an opaque and non-reflective body) held at constant, uniform temperature. The sun is often approximated as a blackbody at a temperature of roughly 5800K.
Byproduction	Production of an element as a secondary product of the mining and refinement of a major (primary) metal. Byproduction can reduce raw material prices substantially due to economies of scope, but the associated price volatility and production ceiling make byproduced elements a potential obstacle to large-scale deployment of some PV technologies.
Cap-and-trade system	A policy regime that involves placing a mandatory cap on emissions of a pollutant (e.g., carbon dioxide) and creating a market for the limited number of rights to emit that pollutant.
Capacity factor (CF)	The ratio of the actual ac energy output [kWh/y] of a generator to the output that would be produced if that generator operated continuously at full capacity. The capacity factor of a PV system is computed without dc-to-ac conversion losses, under constant peak irradiance ($1,000 \text{ W/m}^2$), and at 25°C .
Cation	A positively charged atom or group of atoms. Cations are attracted to the cathode (negative electrode) in an electrolysis reaction.

Combiner box	Electrical equipment that combines the electrical output of multiple series-connected strings of solar photovoltaic modules in series or parallel in order to achieve a desired overall output voltage. The output of the string combiner is typically connected to an inverter or charge-controller. Typically a large number of such boxes are required in utility-scale projects.
Commodity materials	Abundant materials (e.g., glass, concrete, and steel) that are used in PV modules and systems as well as in a variety of non-PV applications. The cost and availability of commodity materials are typically determined by market conditions and production capacity rather than raw abundance.
Concentrated solar power (CSP) system	A solar energy conversion system characterized by the optical concentration of sunlight through an arrangement of mirrors to heat a working fluid to high temperatures; also referred to as a solar thermal system. In current designs, the thermal energy thus captured is used to produce steam that drives a turbine connected to an electric generator. A related term is concentrated solar photovoltaics (CPV), which refers to a system that focuses sunlight on a photovoltaic cell to increase conversion efficiency and reduce the required cell area.
Critical materials	Defined in this study as elements used in the active absorber or electrode layers of PV cells; also referred to as PV-critical materials . These materials are critical for the operation of particular PV technologies but do not necessarily pose a limitation on scaling. Critical materials are often mined as byproducts and typically have few available substitutes for a given PV technology without sacrificing performance.
Crustal abundance	The relative concentration of a chemical element in the Earth's upper continental crust (top ~15 km), typically reported in units of parts per million (ppm) by mass. Oxygen and silicon are the two most abundant elements in the crust.
Czochralski (CZ) process	A method of growing large, high-quality semiconductor crystals by slowly extracting a seed crystal from a molten bath and carefully controlling the cooling process.
Diffuse irradiance	The component of solar radiation received per unit area from all regions of the sky except the direction of the Sun. Diffuse radiation is produced by the scattering of light in the atmosphere (e.g., due to clouds, aerosols, or pollution) and at the Earth's surface; in the absence of atmosphere, there should be almost no diffuse sky radiation.
Direct normal irradiance	The amount of solar radiation received per unit area from the direction of the Sun by a surface whose perpendicular (normal) points directly at the Sun.
Diurnal cycle	Periodic daily variation in available solar radiation due to the Earth's rotation.
Doped semiconductor	A semiconductor with small concentrations of impurities introduced intentionally (doped) to modify its electronic properties. An n-type semiconductor has excess electron-donor impurities (e.g., phosphorous in silicon), while a p-type semiconductor has excess electron-acceptor impurities (e.g., boron in silicon). A photovoltaic cell typically consists of a junction formed between a p-type semiconductor and an n-type semiconductor.
Dye-sensitized solar cell (DSSC)	A photoelectrochemical device that separates the photovoltaic conversion process into two steps — light absorption and charge collection — that occur in different materials. DSSCs mimic the photosynthetic processes typically found in plants and rely on organic dyes to absorb sunlight.
Energy Information Administration (EIA)	An independent agency within the U.S. Department of Energy that develops surveys, collects energy data, and analyzes and models energy issues.

Energy Policy Act of 2005	A statute that affects energy policy in the United States. Key issues that this act addresses include the following: (1) energy efficiency; (2) renewable energy; (3) oil and gas; (4) coal; (5) Tribal energy; (6) nuclear matters and security; (7) vehicles and motor fuels, including ethanol; (8) hydrogen; (9) electricity; (10) energy tax incentives; (11) hydropower and geothermal energy; and (12) climate change technology.
Energy yield	The actual energy output of a PV module or system divided by the nameplate dc capacity, in units of kWh/kWp or hours. The energy yield of a PV module or system over a given time period corresponds to the number of hours for which it would need to operate at peak power to produce the same amount of energy.
Epitaxial growth	The growth of a crystalline film on a crystalline substrate. The deposited film can be the same or a different material from the substrate, but in either case must have a crystal lattice structure (e.g., atomic spacing) compatible with that of the substrate.
Feed-in premium	See output subsidy .
Feed-in tariff	A policy mechanism used to encourage deployment of renewable electricity technologies. A feed-in-tariff program typically guarantees that owners of eligible renewable electricity generation facilities, such as rooftop solar photovoltaic systems, will receive a set price per kilowatt-hour for all of the electricity they generate and provide to the grid.
Grain boundary	The interface between two crystalline domains (grains) in a polycrystalline material.
Insolation	A measure of the solar energy received over a given area over a given time period, typically in units of kWh/m ² /day. Insolation is a contraction of the phrase “incoming solar radiation.” When the time unit in the denominator is omitted, the period of observation must be specified (e.g., “an average daily insolation of 4.5 kWh/m ² ”). The term irradiation is sometimes used interchangeably with insolation.
Intermittency	Temporal variation in the availability of sunlight and hence PV panel output over varying time scales, from seconds to days to seasons. Intermittency can be caused by unpredictable (stochastic) cloud cover and weather or by predictable (deterministic) diurnal, seasonal, and climatic variations. The output of wind generators is also intermittent.
Inverter	A device that converts direct current electricity (e.g., from PV modules) to alternating current to supply power to an electric grid or appliance.
Irradiance	A measure of the solar power received over a given area, typically in units of W/m ² . The average irradiance over a given time period is equal to the insolation over the same period.
Lattice mismatch	A situation that occurs when a crystalline semiconductor is deposited directly (epitaxially) on another crystalline material with a different lattice constant (physical dimension of repeating unit cells in a crystal). When the mismatch is large, defects (dislocations) are likely to arise, increasing recombination and decreasing PV performance. Lattice matching is a key consideration for III-V MJ solar cells, which consist of many stacked epitaxial films with different lattice constants. Lattice-mismatched approaches avoid the need for lattice matching by incorporating a “metamorphic” buffer layer with graded composition to accommodate mismatch.
Levelized cost of energy (LCOE)	A measure of the cost per unit of electrical energy produced by an electric generator, in units of \$/kWh or ¢/kWh. LCOE is the ratio of the present discounted value of the generator’s capital and operating costs to the present discounted value of its electric output.

Manufacturing yield	The product of “line yield,” the fraction of cells or modules not scrapped during manufacture, and “process yield,” the fraction that operate within required performance limits. All else equal, increasing manufacturing yield reduces module cost per watt.
Master limited partnership	A limited partnership that is publicly traded on an exchange. It combines the tax benefits of a limited partnership with the liquidity of publicly traded securities.
Multijunction cell	A solar cell consisting of more than one charge-collecting junction. When stacked in order of decreasing bandgap, multiple junctions allow light of particular wavelength ranges to be absorbed and photovoltaic energy conversion to occur in the sub-cell that incurs minimal thermal losses for that wavelength range.
Nanomaterial	Materials formed of fundamental units with sizes between 1 and 1,000 nanometers (10^{-9} meter) — usually <100 nm in at least one dimension.
Net metering	An electricity pricing system that allows residential and commercial customers who generate their own electricity from solar power to sell their excess electricity back into the grid at retail rates, rather than the wholesale rates received by other generators.
Open-circuit voltage (V_{OC})	The voltage measured across the terminals of a solar cell under illumination when no load is applied. The open-circuit voltage is fundamentally related to the balance between light current and recombination current, and is thus a primary measure of the quality of a solar cell. PV technologies with high open-circuit voltages (i.e., close to the material-dependent bandgap) typically exhibit low internal losses.
Organization for Economic Co-Operation and Development (OECD)	An international organization of 34 relatively wealthy nations that provides a forum for discussion, collects and analyzes data, and issues policy recommendations.
Output subsidy	A subsidy mechanism that gives solar generators a fixed subsidy — which may depend on market prices — per kWh of generation in addition to any revenues from electricity sold. Output subsidies are also known as premium tariffs or feed-in premiums .
Particulate matter	Minute airborne liquid or solid particles (such as dust, fume, mist, smog, smoke) that constitute air pollution. Particulate matter may vary greatly in color, density, size, shape, and electrical charge, and their concentration in the local atmosphere can vary from place to place and from time to time.
Performance ratio (PR)	The ratio of the actual ac energy output [kWh/y] of a PV system to the output of an ideal system with the same nameplate capacity and no dc-to-ac conversion losses, under local insolation conditions (i.e., with the same plane-of-array irradiance) and at 25°C. The PR is equivalent to the capacity factor except in that it uses actual insolation rather than assuming constant peak irradiance. Performance ratios are often reported for individual months or years and are helpful for identifying failure of system components. The quality factor (Q) is the same as the performance ratio.
Photovoltaics (PV)	Devices or systems that convert light into electric power directly through the photovoltaic effect. Photovoltaics are the fastest-growing and most widely deployed solar electric technology in the world today.
PV-critical materials	See critical materials .
PV fraction	Defined in this study as the fraction of global electricity demand satisfied by solar photovoltaics.
Premium tariff	See output subsidy .

Public Utility Regulatory Policy Act (PURPA) of 1978	One part of the National Energy Act of 1978, PURPA contains measures designed to encourage the conservation of energy, more efficient use of resources, and equitable rates. Principal among these were suggested retail rate reforms and new incentives for production of electricity by cogenerators and users of renewable resources.
Quantum dot	A piece of semiconductor that is sufficiently small (typically 1–10 nm) in all three spatial dimensions to exhibit optical and electronic properties different from those of the bulk material. Colloidal quantum dots are synthesized and processed in solution, and they can be deposited at low temperatures to form the absorber layer in a thin-film solar cell.
Recombination	Undesirable but unavoidable loss of charge carriers within a solar cell. Radiative recombination results in emission of a photon and is the basis of light-emitting diode (LED) operation, while non-radiative recombination results in energy loss as heat. Recombination rates are often increased by defects in bulk semiconducting material or at interfaces.
Real estate investment trust (REIT)	A security that can be sold like a stock of an entity that invests in real estate directly, either through properties or mortgages. REITs receive special tax considerations and offer investors a highly liquid method of investing in real estate.
Renewable energy certificates (REC)	Also called tradable green certificates . Certificates that are issued when electricity is generated by approved generators using renewable energy. They can be traded and are typically transferred to authorities to demonstrate compliance with requirements to purchase specified quantities of electricity generated using renewable energy sources.
Renewable Portfolio Standards (RPS)	State policies that require electric distribution utilities to obtain particular quantities of electricity from specific renewable energy sources, such as wind, solar, biomass, and geothermal. Most RPS regimes restrict the regions within which that electricity must be generated.
Seasonal variation	Deterministic variation in the available solar resource on the time scale of months. Seasonal variations are particularly significant at locations far from the equator.
Second law of thermodynamics	[commonly known as the Law of Increased Entropy] Physical principle that asserts that any thermodynamic process must result in an increase in the total entropy, or disorder, of a system. One consequence, for example, is that when two objects are placed in thermal contact, heat always flows from the hotter object to the colder object.
Semiconductor	A material with electrical conductivity that is tunable and intermediate between that of a conductor and that of an insulator. The primary light-absorbing material in most solar cells are semiconductors. Common examples include silicon, gallium arsenide, copper indium gallium diselenide, and cadmium telluride.
Solar constant	Average solar irradiance measured at the top of Earth's atmosphere when the Sun is directly overhead. The solar constant is $\sim 1366 \text{ W/m}^2$.
Solar thermal	See concentrated solar power .
Solar tracking	Movement of a solar panel, mirror, or lens to maintain a desired angular position relative to the Sun. Precise tracking of the Sun is required to concentrate sunlight onto a thermal receiver for CSP or onto a solar cell for CPV.
Specific power	The power output per unit weight of a PV cell or module, in units of W/g. Thin-film solar cells can achieve higher specific power than wafer-based cells based on active layer weight alone, but substrate weight often dominates the specific power of today's thin-film cells.

Spot price	The current (market) price by which a particular good, service, or security can be bought or sold at a particular time and place. About two-thirds of U.S. electricity generation is bought and sold in spot markets for electricity, in which prices are determined at least once an hour and may vary substantially from place to place, depending on the status of the regional electric grid.
Stoichiometry	Expected ratio of elements in a chemical species. A material that is non-stoichiometric may exhibit crystalline defects or undesirable electronic behavior.
Sun	A metric for the light intensity incident on a solar power system. One sun refers to the standard irradiance under Air Mass 1.5 (AM1.5) conditions, or 1000 W/m ² . The degree of solar concentration in a CSP or CPV system is typically described in units of suns (e.g., 100 suns = 100 kW/m ²).
SunShot	An initiative of the DOE Solar Energy Technologies Office (SETO) that seeks to make solar energy cost-competitive with other forms of electricity by 2020. The SunShot Initiative drives research, manufacturing, and market solutions to make the abundant solar energy resource in the United States more affordable and accessible. Since its formation in 2011, the office has funded more than 350 projects in the areas of photovoltaics, concentrating solar power, balance-of-system cost reduction, systems integration, and technology-to-market transition.
Tradable green certificates	See renewable energy certificates .
Transformer	An electromagnetic device that changes the voltage of alternating current electricity. Transformers are used in solar photovoltaic systems to convert the low-voltage output of strings of PV modules to high-voltage ac power suitable for connection to the transmission and distribution grid.



Massachusetts
Institute of
Technology